

Astra Tech Implant System®

Clinical & laboratory manual

# Cement-retained restorations

Astra Tech Implant System® EV

The Astra Tech Implant System EV is designed for ease of use and versatility in providing treatment solutions for your implant patients.

The foundation of this evolutionary system remains the unique Astra Tech Implant System BioManagement Complex, which has been proven to predictably provide long-term marginal bone maintenance and esthetic results.



# Astra Tech Implant System®

## CONTENTS

### Introduction – Astra Tech Implant System® EV

Restorative overview .....	4
Abutment overview .....	5
Implant-abutment interface connection .....	6
Color coding .....	7
Pre-operative procedures .....	8
Restorative procedures .....	9
Identification and markings .....	10
Clinical application .....	12

### Clinical and laboratory procedures

Healing procedures .....	14
– HealDesign™ EV .....	14
Impression procedures .....	16
Master model on implant-level .....	20
Temporization procedures	
– TempDesign™ EV .....	22
– Temp Abutment EV .....	22
Final restorations	
– Atlantis® Abutment .....	28
– TiDesign™ EV/ ZirDesign™ EV .....	32
– TitaniumBase EV .....	38
– CastDesign™ EV .....	40
– Direct Abutment™ EV .....	44
Torque Wrench EV – restorative handling .....	50
Torque guide .....	52
Explanation of the symbols on labels and instructions for use .....	52
Cleaning and sterilization instructions .....	53

This manual is designed for use by clinicians who have undergone at least basic prosthetic and in-clinic implant training. Staying current on the latest trends and treatment techniques in implant dentistry through continued education is the responsibility of the clinician.

All products may not be regulatory cleared/released/licensed in all markets. Please contact the local Dentsply Sirona sales office for current product assortment and availability.

To improve readability for our customers, Dentsply Sirona does not use ® or ™ in body copy. However, Dentsply Sirona does not waive any right to the trademark and nothing herein shall be interpreted to the contrary.

Product illustrations are not to scale.

# Restorative overview

## Temporary solutions

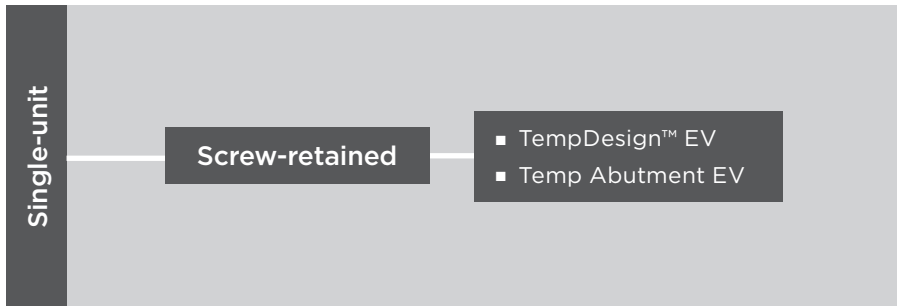
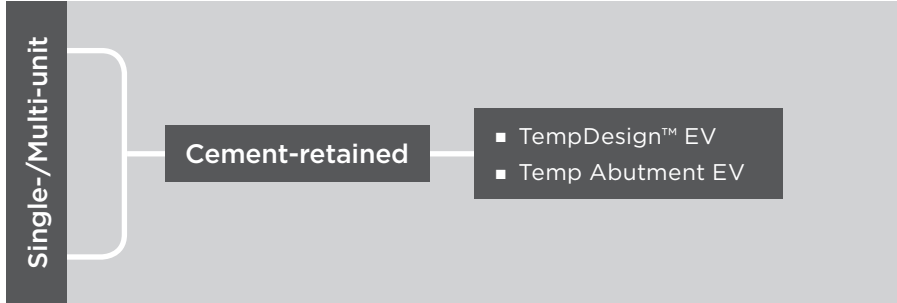
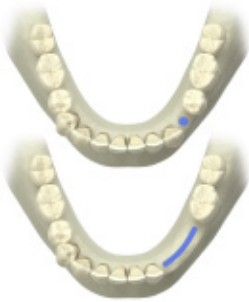

## Final solutions

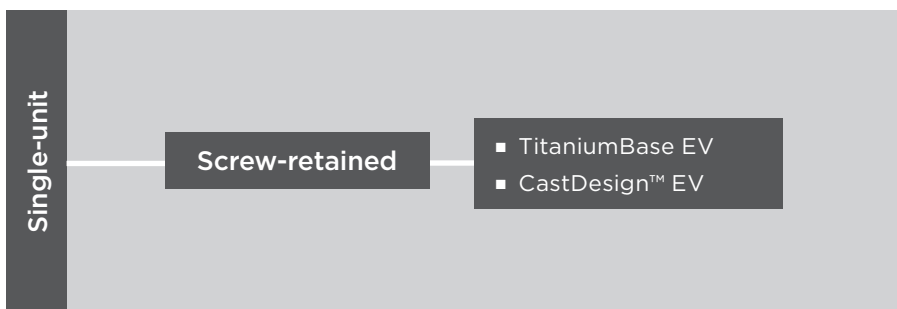
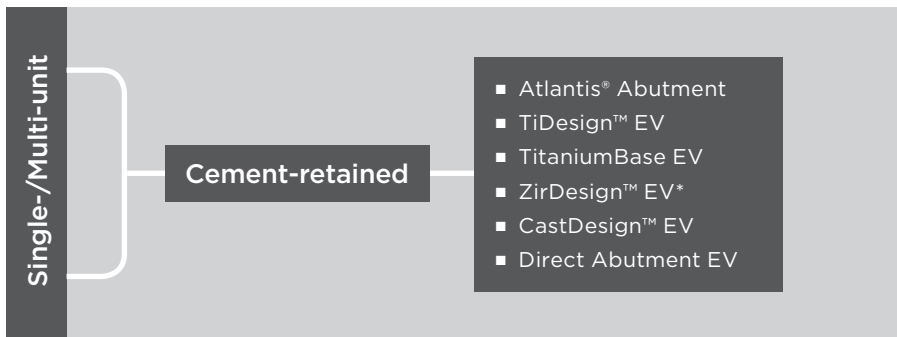

















\* Anterior, canine and premolar

# Abutment overview

Astra Tech Implant System EV includes an abutment assortment, including patient-specific abutments and a wide range of prefabricated abutments designed to satisfy all implant indications. The abutments are produced in different materials in order to support

varying loading conditions and choice of permanent restoration. Throughout this manual, symbols are used to illustrate the indexing options. Below is a comprehensive overview of the abutments and symbols.

Temporary abutments	Indexing option	Clinical application	Features and benefits	Page
<b>TempDesign™ EV</b> Base: Titanium Cylinder: PEEK plastic 	Six positions 	<ul style="list-style-type: none"> <li>Single, partial and fully edentulous situations</li> <li>All positions in the mouth</li> <li>Screw-retained restorations, limited to single-tooth only</li> </ul>	<ul style="list-style-type: none"> <li>Designed for reduction technique</li> <li>Facilitates soft tissue sculpturing</li> <li>Developed for esthetic temporization</li> <li>Design compensates for off-set positions</li> <li>PEEK plastic - recommended for clinical use up to 180 days</li> </ul>	23
<b>Temp Abutment EV</b> Titanium 	Six positions 	<ul style="list-style-type: none"> <li>Single, partial and fully edentulous situations</li> <li>All positions in the mouth</li> <li>Screw-retained restorations, limited to single-tooth only</li> </ul>	<ul style="list-style-type: none"> <li>Designed for individual build-up technique</li> <li>Developed for large multi-unit restorations</li> <li>Designed for long-term temporization</li> </ul>	23
Final abutments	Indexing option	Clinical application	Features and benefits	Page
<b>Atlantis® Abutment</b> Titanium Gold-shaded titanium Zirconia 	One-position-only 	<ul style="list-style-type: none"> <li>Single, partial and fully edentulous situations</li> <li>All positions in the mouth</li> </ul> <p><b>Note:</b> Use of zirconia abutments should be carefully evaluated in situations with unfavorable loading conditions.</p>	<ul style="list-style-type: none"> <li>Patient-specific abutments individually designed from the final tooth shape utilizing the Atlantis VAD software</li> </ul>	29
<b>TiDesign™ EV</b> Titanium 	Six positions 	<ul style="list-style-type: none"> <li>Single, partial and fully edentulous situations</li> <li>All positions in the mouth</li> </ul>	<ul style="list-style-type: none"> <li>Round - design for the majority of restorative situations</li> <li>Triangular - primarily for incisors and canines with triangular shape</li> <li>Angled - for offset situations compensating for implants in a restoratively unfavorable position</li> </ul>	33
<b>TitaniumBase EV</b> Titanium 	Six positions 	<ul style="list-style-type: none"> <li>Single and partial situations, all positions in the mouth</li> <li>For temporary and final cement- / screw-retained restorations</li> <li>Screw-retained restorations, limited to single-tooth only</li> </ul> <p>TitaniumBase EV is provided with two flattened sides forming an anti-rotational feature Indexed abutments will seat in six available positions</p>	<ul style="list-style-type: none"> <li>Individually designed for esthetic results</li> <li>High mechanical integrity</li> <li>A strong and stable base</li> </ul>	38
<b>ZirDesign™ EV</b> Zirconia 	Six positions 	<ul style="list-style-type: none"> <li>Single, partial and fully edentulous situations</li> <li>Anterior, canine and premolar</li> </ul> <p><b>Note:</b> Use of zirconia abutments should be carefully evaluated in situations with unfavorable loading conditions.</p>	<ul style="list-style-type: none"> <li>Round - design for the majority of restorative situations</li> <li>Triangular - primarily for incisors and canines with triangular shape</li> <li>Angled - for offset situations compensating for implants in a restoratively unfavorable position</li> </ul>	33
<b>CastDesign™ EV</b> Base: Gold-alloy Cylinder: PMMA Burn-out plastic 	Six positions 	<ul style="list-style-type: none"> <li>Single, partial and fully edentulous situations</li> <li>All positions in the mouth</li> <li>Screw-retained restorations, limited to single-tooth only</li> </ul> <p><b>Note:</b> In cases where high biteforces are expected it is recommended to select a titanium abutment if possible. CastDesign should primarily be regarded as an abutment used when no titanium option is available.</p>	<ul style="list-style-type: none"> <li>Designed in the laboratory</li> <li>Compensates for angulations up to 30°</li> </ul>	41
<b>Direct Abutment™ EV</b> Titanium 	Index free 	<ul style="list-style-type: none"> <li>Single, partial and fully edentulous situations</li> <li>All positions in the mouth</li> </ul>	<ul style="list-style-type: none"> <li>The one-piece abutment is delivered sterile</li> </ul>	45

## Implant size/tooth position

The design philosophy of the Astra Tech Implant System EV is based on the natural dentition utilizing a site-specific, crown-down approach supported by an intuitive surgical protocol and a simple prosthetic workflow.

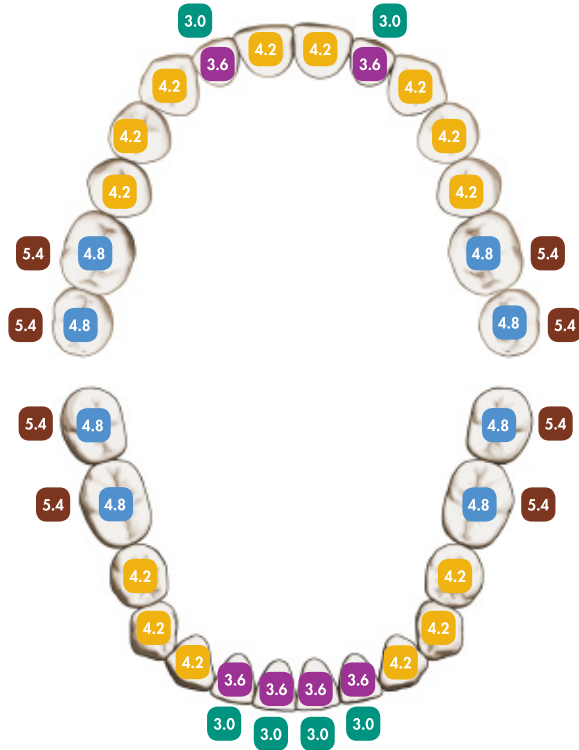

Multiple considerations are required for each tooth replacement, such as the support needed for the final restoration in the particular position, soft-tissue healing, and implant design and size.

The illustration indicates the recommended implant sizes in relation to the natural dentition, provided there is sufficient bone volume and space in relation to adjacent dentition.

### OsseoSpeed® Profile EV

For additional information on OsseoSpeed Profile EV, please refer to the OsseoSpeed Profile EV manual/product catalog.

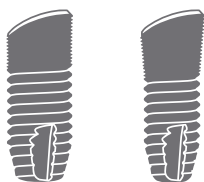

## Implant-abutment interface connection

The **OsseoSpeed EV** implant has a unique interface for one-position-only placement for restorative procedures and components, e.g. the Atlantis patient-specific abutments. The interface also allows for the flexibility of six-position indexing of prefabricated abutments, while index-free abutments can be seated in any rotational position.



OsseoSpeed EV

### Abutment placement option

#### One-position-only

Atlantis patient-specific abutments will seat in one position only.



#### Six positions

Indexed abutments will seat in six available positions.



#### Index free

Index-free abutments will be seated in any rotational position.



## One system – one torque

All final abutments are designed for a uniform torque (25 Ncm), for added simplicity. Due to clinical considerations, the temporary abutments have been verified for a lower torque (15 Ncm).

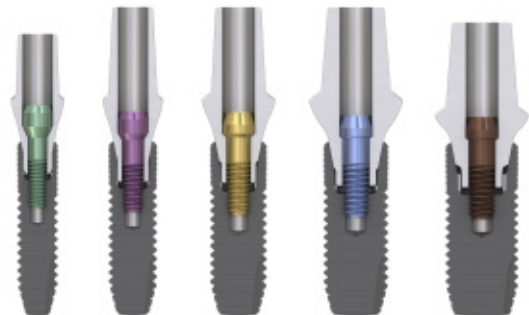

## Color coding

Throughout the Astra Tech Implant System EV, markings, color coding and geometrical designs simplify the correct identification of corresponding components.

Each implant-abutment connection size is identified by a specific color, which is used consistently throughout the system. The color is applied directly to components and instruments, as well as on packaging and informational material, where appropriate.

The following components and/or packaging are color-coded:

Green	Purple	Yellow	Blue	Brown
<b>3.0</b>	<b>3.6</b>	<b>4.2</b>	<b>4.8</b>	<b>5.4</b>
Ø 3.0	Ø 3.6	Ø 4.2	Ø 4.8	Ø 5.4



Packaging for components on implant-level



Abutment screws for two-piece abutments



Healing components



Impression and laboratory components on implant-level

# Pre-operative procedures

## Pre-operative examination

An evaluation of the patient's general and oral health, with clinical and radiographic examinations, must be performed. Particular attention should be given to mucous membranes, jaw morphology, dental and prosthetic history, and signs of oral dysfunction.

Radiographic analysis should be used to evaluate bone topography of the residual alveolar process. The initial radiographic evaluation, together with the clinical examination, is the basis for determining whether or not a patient is a candidate for implant treatment.

If the patient is found to be suitable, a more thorough clinical examination of the area for treatment and the opposing jaw should be performed. Any local pathology in the jaws should be treated before implant placement.

## Pre-operative planning

Pre-operative planning should be based on the expected restorative treatment outcome. The Astra Tech Implant System EV assortment is designed to meet the prosthetic needs for the tooth replacement planned. The prosthetic versatility in materials, designs and sizes is aligned with the implant for support of the tooth replacements in the different positions in the jaw.

To achieve the expected outcome, treatment planning should include all stages of the procedure, from healing time and components to provisional and final restorations.

Today, digital processes with CBCT scans, together with optical surface scans, can replace or complement models mounted on an articulator and provide (analog or virtual) information of the relationship between jaws and teeth. A diagnostic wax-up with the missing teeth replaced provides important information in the planning phase. Based on analysis and evaluation of the occlusal table, force distribution and preferred sites for the implants, an optimal plan can be achieved. The transparent Radiographic Implant Guides displaying implants in different magnifications are helpful in planning optimal position, direction and implant size. When working in a digital environment, the planning software provides a library of the different implants.



Simplant, the computer guided implant treatment software, can be used for the Astra Tech Implant System EV to ensure accurate planning for optimized implant position and placement.

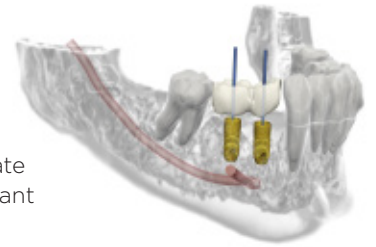

Even though the final treatment approach may be determined at the time of surgery, consider the following based on the quality of supporting bone and expected initial stability of the implant(s):

- One- or two-stage surgical procedure
- Immediate or early loading protocol
- Expected healing time before loading

When the prerequisites for immediate loading cannot be met, an early loading protocol (at least six weeks healing period) may be considered.

In all situations, bone quality and quantity, primary stability achieved, design of restoration, and loading conditions should be carefully examined and assessed by the clinician when determining time to loading of implants for each individual case.

Before treatment begins, the patient should be informed about the results of the pre-operative examination and given a clear explanation of what is entailed by the planned treatment, including the expected outcome, maintenance requirements and risks involved.



# Restorative procedures

The following chapter provides detailed procedures for restoring OsseoSpeed EV implants. Restorations can be built from implant or abutment level.

In addition to supporting a functional tooth replacement, the final abutment should minimize the risk of possible overload by reducing transferring forces to the implant.

Abutment selection should take into account the following:

- Clinical application — single, partial and fully edentulous situations
- Type of restoration – technique and material
- Implant-level or abutment-level impression technique
- Anterior or posterior location
- Esthetic demands
- Implant angulations
- Tissue conditions
- Occlusal interproximal space
- Adjacent teeth



## Orientation

The procedure sequence, as seen below, illustrates the different restorative stages and the products used and can be found throughout the manual for easy reference. The stage of the treatment procedure being reviewed is highlighted with a circle.

## Restoring on implant-level

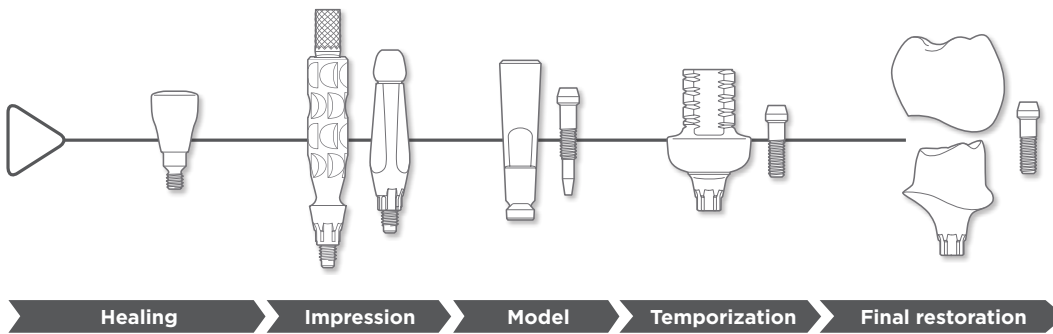

## Restoring on abutment-level

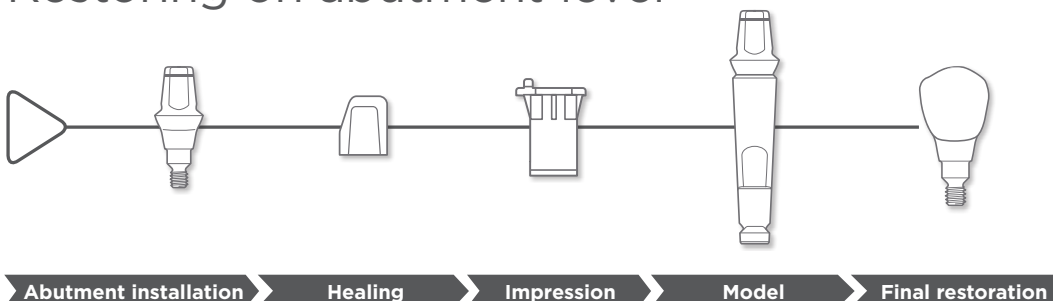









# Identification and markings

The markings, color coding, and geometrical design of the Astra Tech Implant System EV helps to simplify the identification of corresponding components.

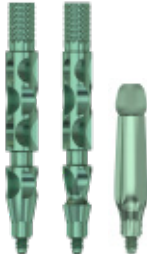
Each implant-abutment connection size is identified by specific colors which are used consistently throughout the system, and have been applied directly to components and instruments, as well as on packaging and information material, where applicable. The following prosthetic and laboratory components are color coded:

Healing abutments are marked to identify diameter and height.



	<b>3.0</b>	<b>3.6</b>
<b>Healing components</b>	 HealDesign EV	 HealDesign EV
<b>Impression components</b>	 Implant Pick-up EV / Implant Pick-up Design EV Implant Transfer EV	 Implant Pick-up EV / Implant Pick-up Design EV Implant Transfer EV
<b>Abutment screws</b>	 Abutment Screw EV	 Abutment Screw EV
<b>Laboratory components</b>	 Implant Replica EV / Lab Abutment Screw EV	 Implant Replica EV / Lab Abutment Screw EV

## Surgeon-referral-laboratory communication form

To ensure proper communication among the entire treatment team, the surgeon-referral-laboratory communication form is recommended to clearly indicate which implant(s) is/are placed for each tooth position, and the corresponding component(s) utilized.

The Astra Tech Implant System™ EV was used for this case

DesignEV	Implant type	Transfer	Product Label	Product Link
	<input type="checkbox"/> HealDesign™ EV			
	<input type="checkbox"/> HealDesign™ EV			
	<input type="checkbox"/> HealDesign™ EV			
	<input type="checkbox"/> HealDesign™ EV			
	<input type="checkbox"/> HealDesign™ EV			
	<input type="checkbox"/> HealDesign™ EV			
	<input type="checkbox"/> HealDesign™ EV			
	<input type="checkbox"/> HealDesign™ EV			

4.2

4.8

5.4



HealDesign EV



HealDesign EV



HealDesign EV



Implant Pick-up EV / Implant Pick-up Design EV  
Implant Transfer EV

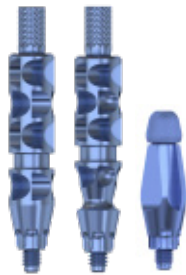

Implant Pick-up EV / Implant Pick-up Design EV  
Implant Transfer EV



Implant Pick-up EV / Implant Pick-up Design EV  
Implant Transfer EV



Abutment Screw EV



Abutment Screw EV



Abutment Screw EV



Implant Replica EV / Lab Abutment Screw EV

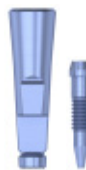

Implant Replica EV / Lab Abutment Screw EV





Implant Replica EV / Lab Abutment Screw EV

## Clinical application

OsseoSpeed EV implants are indicated for immediate placement in extraction sites and/or in partially or completely healed alveolar ridges using a one- or two-stage surgical procedure.

Implants with the OsseoSpeed surface are especially indicated for use in soft bone situations where implants with other surface treatments may be less effective.

OsseoSpeed EV implants can be used in an immediate loading protocol. However, for single-tooth replacement in soft bone or when using a 6 mm implant, where primary implant stability may be difficult to maintain, immediate loading may not be appropriate and thus not recommended.

Implant shape	General clinical application	3.0	3.6
<b>Straight</b> 	Suitable in the majority of situations.	For replacement of maxillary lateral and mandibular central and lateral incisors when there is not enough space for a wider implant.	Used in situations with limited bone volume or space between adjacent teeth, where a 4.2 mm implant is judged to be too wide.
<b>Conical</b> 	In situations with limited bone volume and where a larger prosthetic platform is preferred.	N/A	N/A

**Precaution:** When treatment planning for an implant with 6 mm length consider the widest possible implant, a two-stage surgical approach and splinting of implants. Closely monitor the patient for peri-implant bone loss or change in the implant's response to percussion. If the implant shows greater than 50% bone loss or mobility, consider possible removal of implant.

Based on mechanical strength considerations, it is recommended to always place the widest implant possible for the edentulous space. This is particularly important in the posterior regions of the jaws where loading forces are high and considerable bending moments could be generated.

In all cases, it is important to consider loading conditions when determining the number and spacing of implants.

4.2	4.8	5.4
Suitable in the majority of situations.	Used in situations with enough bone volume.	Suitable in situations with wide ridges and large edentulous spaces.
Suitable in situations with limited bone volume where a 3.6 mm implant diameter is the choice but where a larger prosthetic platform is preferred.	Suitable in situations with bone volume where a 4.2 mm implant diameter is the choice but where a larger prosthetic platform is preferred.	N/A

## HealDesign™ EV

The design of the healing abutments is based upon the natural dentition utilizing a site-specific, crown-down approach. The round and triangular options mimic a variety of tooth shapes and support the soft tissue preparing for the final abutment.

- Heights and diameters are harmonized with the final abutments and with the expected tooth positions
- Round shapes are indicated for all positions in the mouth

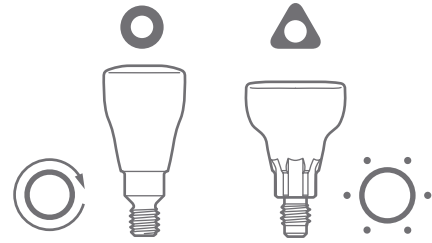

- Triangular shapes are designed for anterior implant sites and mimic the specific shape for incisors and canines

### Clinical procedure – HealDesign™ EV, round

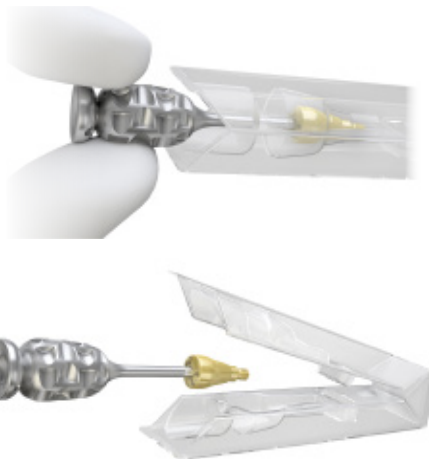

#### Selection

- Select a round HealDesign EV to promote the desired final soft tissue anatomy.

#### Picking up

- Pick up and install the sterile HealDesign EV directly from the blister package, using the Hex Driver EV.

#### Installation

- The round HealDesign EV is index free.
- Manually seat and secure the healing abutment using light finger force (5–10 Ncm).

#### Note:

- The protocol describes an implant placement flush to or slightly below bone level.
- Make sure no bone or soft tissue is trapped between healing abutment and implant. This is increasingly important if the implant is placed submerged.
- If a narrow healing abutment is selected in situations with thick gingiva, the soft tissue can be too tight for the impression component when making impressions at the implant level. Therefore the selection of healing abutment is important.

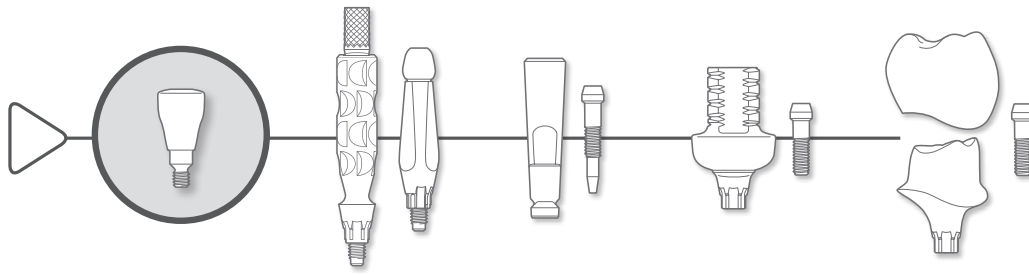

## Clinical procedure - HealDesign™ EV, triangular

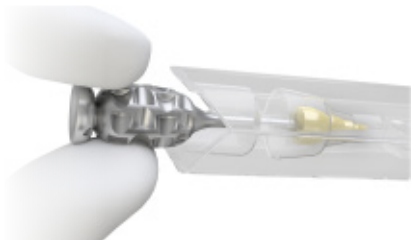

### Selection

- Select a triangular HealDesign EV to promote the desired final soft tissue anatomy.

### Picking up

- Use the Hex Driver EV to pick up the sterile HealDesign EV directly from the blister package and install.

### Installation

- The triangular HealDesign EV has six possible placement options. Manually seat the healing abutment in the preferred index position before securing the screw using the Hex Driver.
- Manually tighten the healing abutment using light finger force (5-10 Ncm).

**Note:** When removing a two-piece component, keep the sleeve and screw assembled.

## Implant Pick-Up EV

Implant pick-ups are used for open-tray impression procedures. The various designs support different preferred techniques for capturing the soft tissue architecture.

The design of the impression copings captures all the necessary information from the implant interface, regardless of the abutment solution.



### Implant Pick-Up EV Implant Pick-Up Design EV

- Self-guiding impression component; engages into the implant only when correctly seated
- One hand procedure
- Supports all indexing options; one-position-only, six position and index free
- Integrated pin for safe handling
- Capturing individualized sculptured soft tissue

## Clinical procedure - open tray

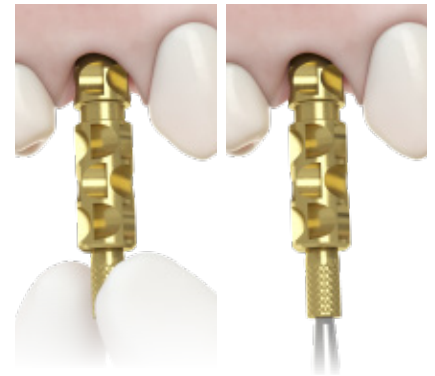
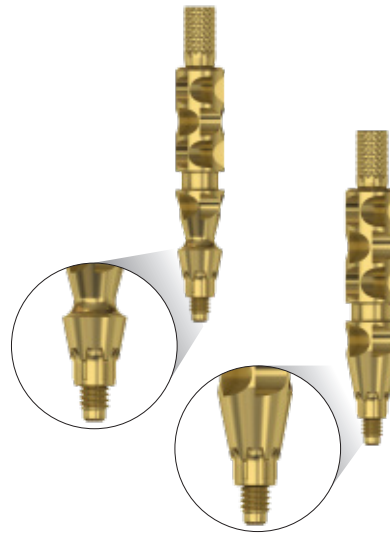

### Impression tray

- Prepare and use a standard or customized impression tray.

### Selection

- Select an appropriately contoured implant pick-up to promote the desired final soft tissue anatomy.

**Note:** The included pin is only to be used together with the assembled sleeve.

### Installation

- Use the Hex Driver EV to pick up and connect the Implant Pick-Up EV.
- Secure the implant pick-up with manual tightening torque (5-10 Ncm) using the Hex Driver.

**Note:** The Implant Pick-Up EV has a self-guiding feature that requires only one hand for seating and is designed to engage only in the correct position.



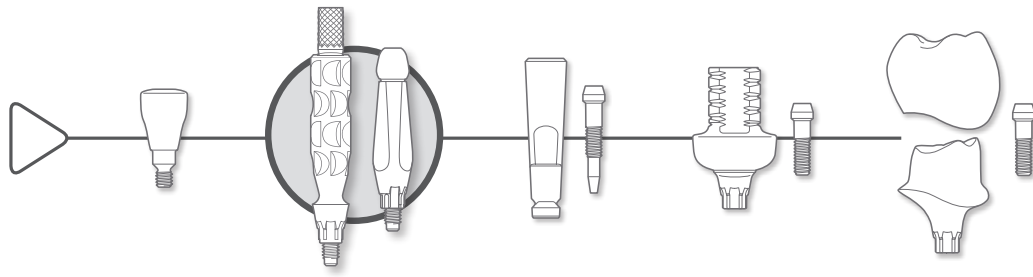

### Impression taking

- Apply impression material on the implant pick-up separately.
- Place the tray, filled with impression material and make the impression.

### Removing the impression

- Once the impression material has set, unscrew the pin and remove the impression.
- Make sure that the pin is completely disengaged from the implant, before removing the impression.
- Check the impression for correct and stable retention of the Implant Pick-up EV.

**Note:** For Implant Pick-Up Design EV fill the soft tissue void close to the connection using a light-body impression material (or a rigid material such as light-curing composite, acrylic resin, etc.) for optimal fill out and replication.

# Implant Transfer EV

Implant transfers are used for closed-tray impression procedure.

The design of the impression copings captures all the necessary information from the implant interface, regardless of the abutment solution.

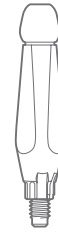

## Implant Transfer EV

- Self-guiding impression component; engages into the implant only when correctly seated
- One hand procedure
- Supports all indexing options; one-position-only, six positions and index free

## Clinical procedure - closed tray

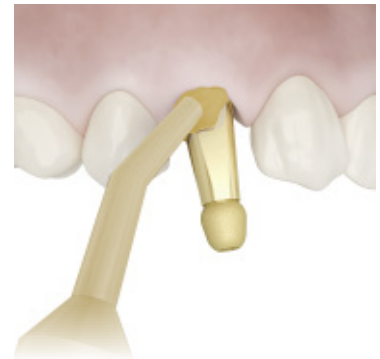

### Impression tray

- Prepare and use a standard or customized impression tray.

### Selection

- Select an appropriate height of the Implant Transfer EV that supports the individual clinical situation.
- Connect the implant transfer using the pin as a carrier or use the Hex Driver EV.
- The Implant Transfer EV is self-guiding into the correct index position.
- Secure the implant transfer with manual tightening torque (5-10 Ncm) using the hex driver.

**Note:** The transfer has a self-guiding feature that requires only one hand for seating and is designed to engage only when in the correct position.

### Impression taking

- Apply elastomeric impression material on the Implant Transfer EV separately. Place the tray, filled with impression material and take the impression.

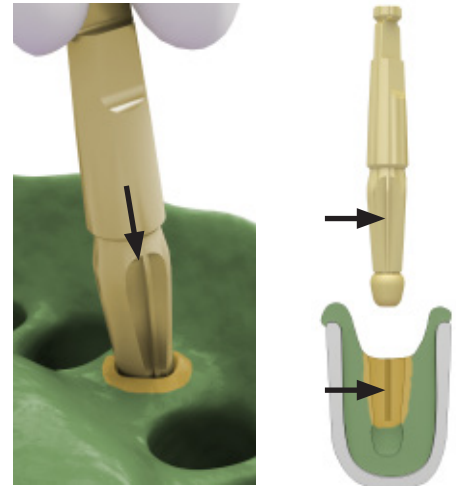
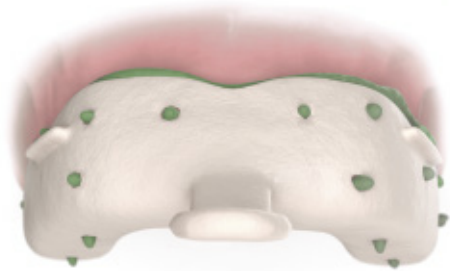
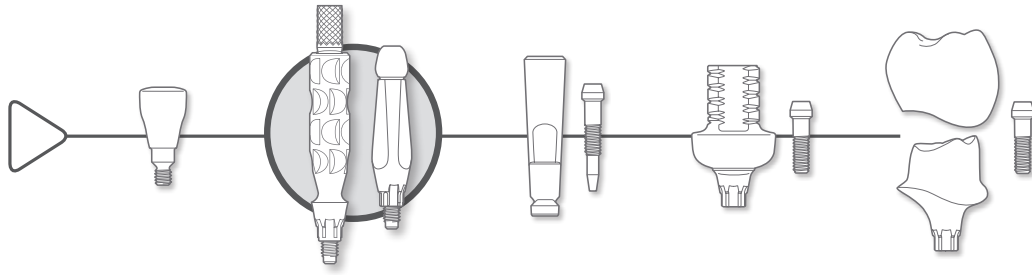

### Removing and checking the impression

- Once the impression material has set, remove the impression and then unscrew the implant transfer.

### Mount the Implant Replica EV and the Implant Transfer EV

- Mount replica and transfer outside the impression and carefully re-insert into the impression.
- Check the impression and ensure there is sufficient impression material for correct and stable retention of the implant transfer.
- Placing the correct implant transfer back into the impression together with the appropriate implant replica at the clinic is recommended to avoid mistakes.
- If there are several different interface connections or transfer lengths, make sure to identify each and communicate to the lab.

### Position the implant replica/implant transfer in the impression

- Re-insert the replica/transfer into the impression carefully.
- Wet the transfer with water before putting it back into the impression.
- Aim the "ridge" (see image) on the implant transfer towards the mark in the impression void and press down.
- Rotate the transfer when in the impression, a small snap will determine the correct position.

# Implant Replica EV

Implant Replica EV (together with Lab Abutments Screws EV) are necessary for efficient and safe laboratory fabrication of implant-level restorations. With minimal modification, the Implant Replica EV can allow for removal and repositioning without sectioning the master model.



## Implant Replica EV

- Can be removed and repositioned into master model after simple modification of the replica apex
- Color: according to implant



## Lab Abutment Screw EV

- Lab Abutment Screw EV is primarily used at the laboratory by the dental technician and fits only into the Implant Replica EV and not any implant due to its specific guiding tip
- Designed not to be compatible with the implant
- Guide tip supports efficient lab handling
- Color: according to implant

## Laboratory procedure

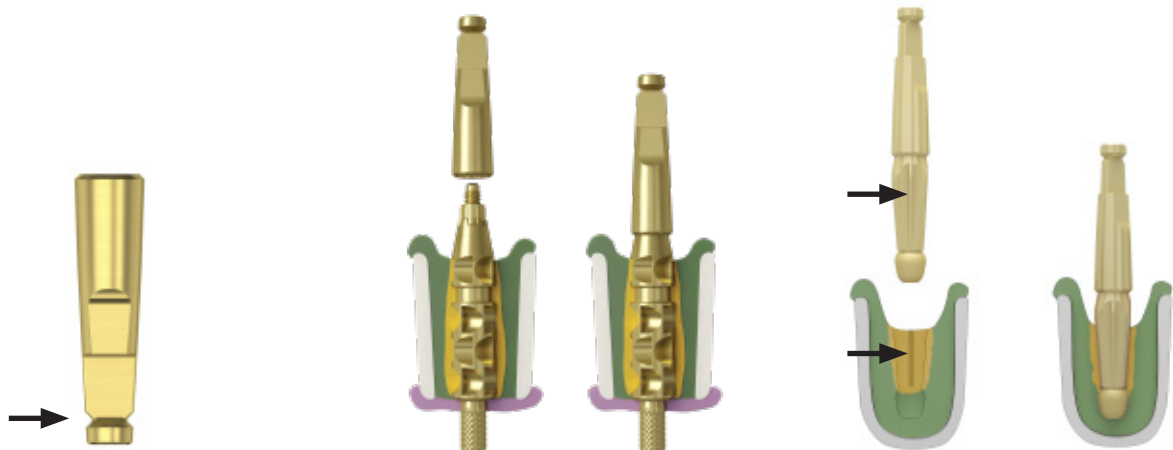

### Implant Replica EV

- Select the appropriate Implant Replica EV corresponding to the impression element. Use the color identification together with information from the clinician.
- If a removable implant replica is preferred, cut off the "coin" on the replica apex and smooth the cut surface area to avoid any damage of the master model.
- If using the removable replica feature, make sure the replica is correctly re-seated all the way down in the unique one-position in the master model.

**Note:** Use of several different removable Implant Replicas in one master model may increase the risk of incorrect repositioning.

### Implant Pick-Up EV Implant Pick-Up Design EV - open tray

- Place the Implant Replica EV carefully in the correct position towards the Implant Pick-Up EV.
- Secure the Implant Replica EV by rotating the Implant Pick-Up Pin using manual tightening.

**Note:** The included pin is only to be used together with the assembled sleeve and cannot be used for securing two-piece abutments to replicas or implants.

### Position the implant replica/implant transfer in the impression

- Re-insert the replica/transfer into the impression carefully.
- Wet the transfer with water before putting it back into the impression.
- Aim the "ridge" (see image) on the implant transfer towards the mark in the impression void and press down.
- Rotate the transfer when in the impression, a small snap will determine the correct position.

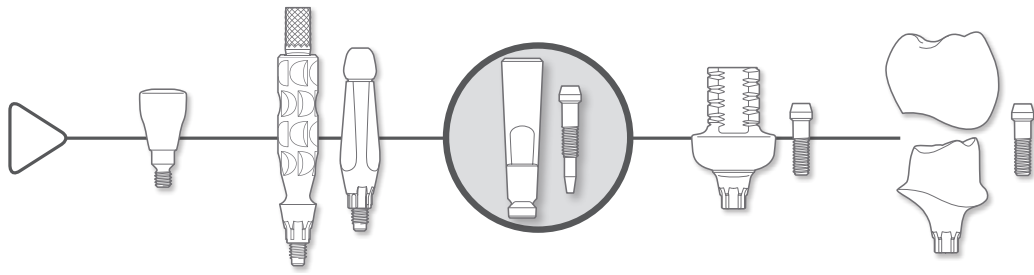

### Master model

- Prepare the impression for duplication with a removable soft tissue mask by applying silicone around the implant replica site. Pour high quality stone and fabricate the master model.

## Workflow – TempDesign™ EV/ Temp Abutment EV

The procedure sequence, as seen below, illustrates the different restorative stages and the products used and can be found throughout the manual for easy reference. The stage of the treatment procedure being reviewed is highlighted with a circle.

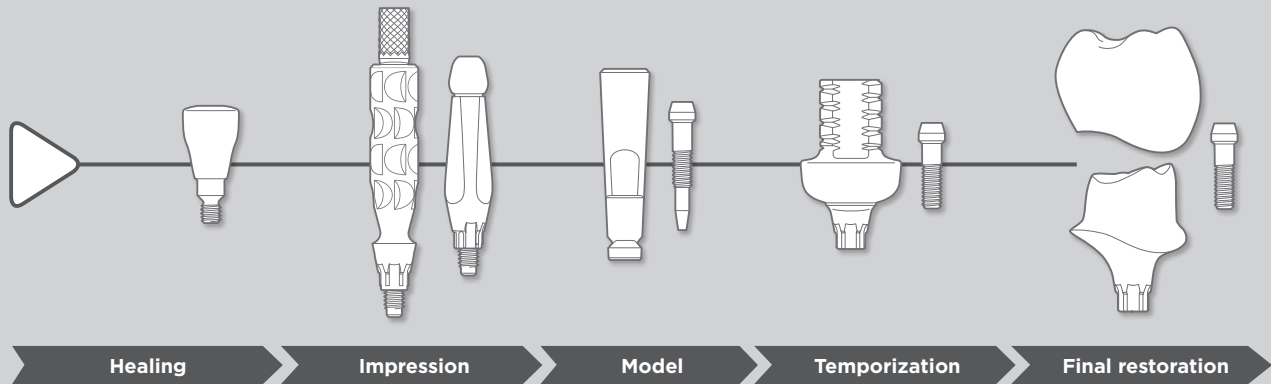

# TempDesign™ EV/ Temp Abutment EV

## Clinical application

- Single, partial and fully edentulous situations
- All positions in the mouth
- Screw-retained restorations, limited to single-tooth only

## TempDesign™ EV Temp Abutment EV

Function as customized bases for temporary implant-level restorations and allow for further sculpturing of the soft tissue as needed.

- Designed with indexing feature that allows for placement in six positions
- Color-coded abutment screws according to implant-abutment connection size

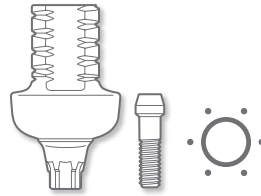

### TempDesign™ EV

- Designed for reduction technique
- Developed for esthetic temporization
- Design compensates for off-set positions
- PEEK plastic - recommended for clinical use up to 180 days

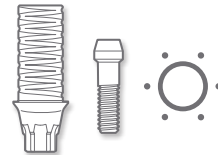

### Temp Abutment EV

- Designed for build-up technique
- Developed for multi-unit restorations
- Designed for long-term temporization



## Screw-retained temporary options

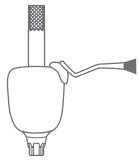

Composite crown built up and cured directly onto the modified temporary abutment.

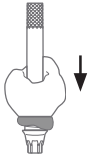

Prefabricated plastic crown shell/denture tooth, integrated to the modified temporary abutment with acrylic.

### Laboratory procedure

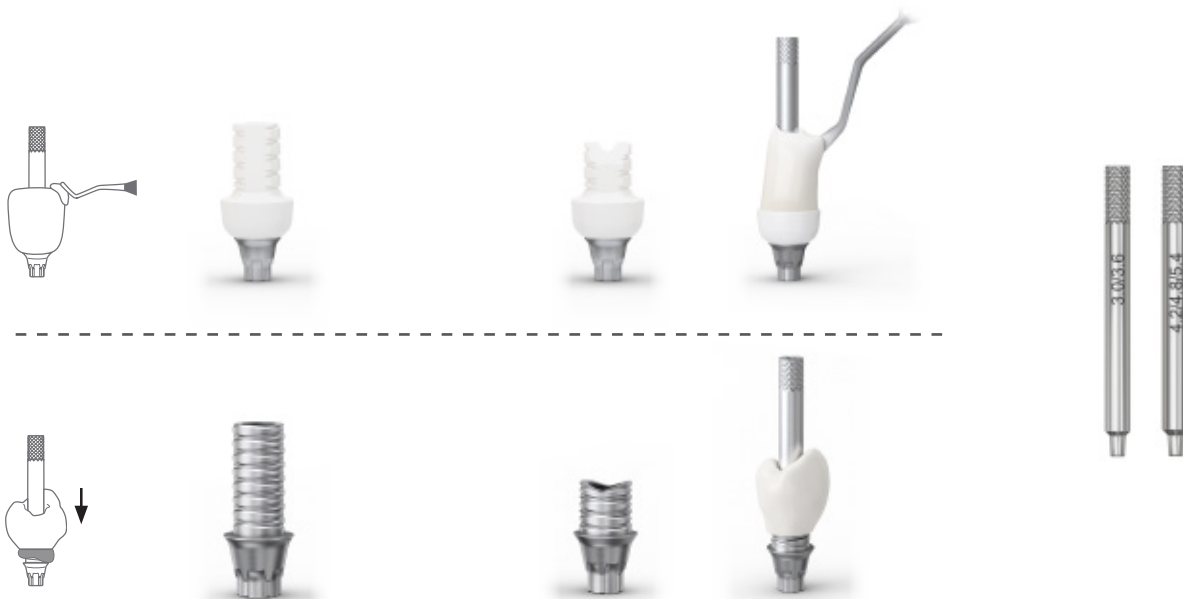

#### Abutment selection

- Try in the abutment and mark for modification.
- Use the Lab Abutment Screw EV when fabricating the temporary restoration.
- Harmonize the abutment margin with the soft tissue shape.
- Design the abutment to function as retentive base for the composite/acrylic.

**Note:** The Lab Abutment Screw EV is developed exclusively for use with Implant Replica EV. Clinical abutment screws should not be used in the laboratory.

#### Composite crown

- Build up the crown structure on the abutment by layering the different composite veneers; keep screw access hole open by using the Lab Pin Design EV.

#### Prefabricated plastic crown

- Select a plastic crown shell/denture tooth.
- Modify it to fit the abutment with a screw access hole.
- Fill the crown with acrylic and position it on the abutment; keep screw access hole open by using a Lab Pin Design EV.

**Note:** The PEEK plastic part of TempDesign EV only bonds mechanically to dental acrylics and composite.

#### Lab Pin Design EV

- Lab Pin Design EV used for maintenance of screw access channel during the laboratory procedure.
- Friction fit to the Lab Abutment Screw EV.
- Two sizes, 3.0/3.6 and 4.2/4.8/5.4



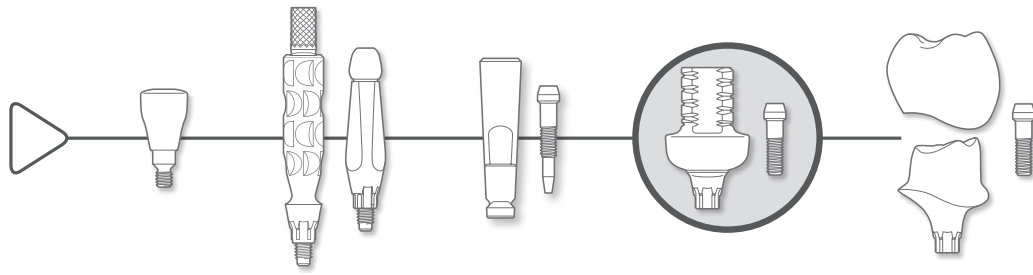

## Clinical procedure

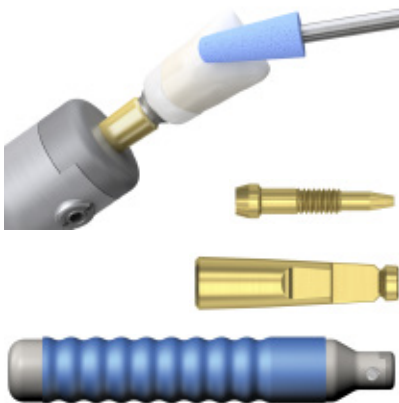

### Finishing

- Finalize the temporary crown abutment design. Adjust if necessary and polish the restoration.
- Mount the abutments in a Grinding Handle with a separate replica and the Lab Abutment Screw EV for safe and easy modification.
- Use grinders manufactured for the specific restorative material.
- Perform a final try-in on the model.

### Abutment installation

- The abutments have six possible placement options. Manually seat the abutment in the preferred index position before securing the abutment screw using the Hex Driver EV.
- Final tightening to the recommended torque (15 Ncm) using the Restorative Driver Handle EV together with machine Hex Driver EV and Torque Wrench EV.

**Note:** Abutment Screw EV should only be used clinically.

- Cover the screw head before the screw channel is filled with a suitable material.
- Seal the crown abutment hole using a preferred technique.
- Check the contact of the adjacent teeth and correct occlusal relation.
- **Note:** For chair side modification by the clinician, the lab abutment screw is also recommended together with the appropriate implant replica and a grinding handle to avoid intra-oral grinding.



## Cement-retained temporary options

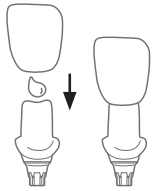

Prefabricated plastic crown shell/denture tooth, cemented onto a modified abutment.

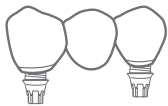

Reinforced provisional bridge restoration, cemented onto the modified temporary abutments.

### Laboratory procedure

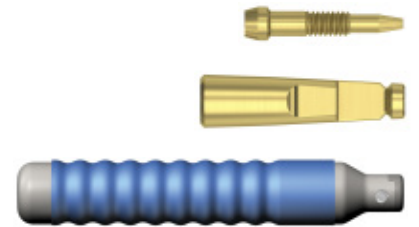
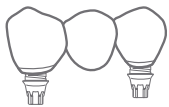
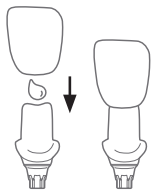

#### Abutment selection

- Select and try in the abutment and do the necessary modifications.

#### Modification

- Use the Lab Abutment Screw EV when fabricating the temporary restoration.
- Harmonize the TempDesign EV margin with the soft tissue shape.
- The PEEK plastic part of TempDesign EV only bonds mechanically to dental acrylics and composite.

**Note:** For chair-side modification by the clinician, the lab abutment screw is recommended together with the appropriate implant replica and a grinding handle to avoid intra-oral grinding.

#### Instruments

- Always mount the abutments in a Grinding Handle with a separate replica for safe and easy modification.
- Use grinders manufactured for the specific restorative material.

**Note:** The Lab Abutment Screw EV is developed exclusively for use with Implant Replica EV, and no clinical abutment screw should be used in the laboratory.

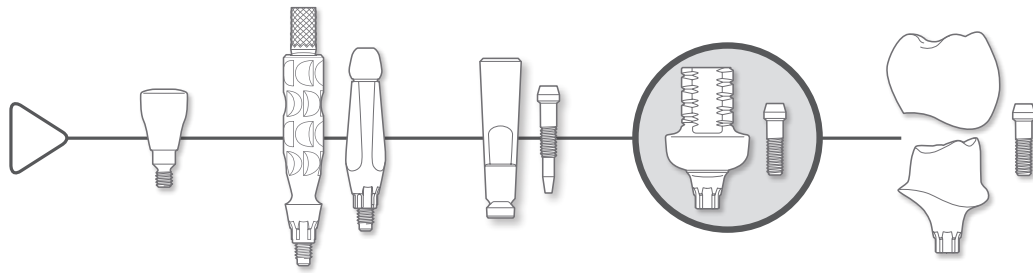

## Clinical procedure



### Prefabricated crown

- Select a corresponding plastic crown shell or denture tooth.
- Modify the crown to fit onto the abutment and adjust the margin shape.
- Polish and finalize the restoration. Perform a final try-in on model.

### Provisional bridge

- Fabricate a metal or fiber reinforced bridge framework.
- Build up the framework with composite veneers or prefabricated teeth and acrylic and fit with the adjusted abutment margin shapes.
- Finalize the temporary bridge by curing.
- Polish and finalize the restoration. Perform a final try-in on model.

### Abutment installation

- The abutments have six possible placement options. Manually seat the abutment in the preferred index position before securing the abutment screw using the Hex Driver EV.
- Final tightening to the recommended torque (15 Ncm) using the Restorative Driver Handle together with machine Hex Driver EV and Torque Wrench EV.



### Cementation

- Cover the screw head before the screw channel is filled with a suitable material.
- Cement the crown/bridge onto the abutment and carefully remove all excess cement.
- Cementation technique should be adapted to the restoration of choice and according to the instructions from the manufacturer.
- Check the contact with adjacent teeth and make corrections to the occlusal relation as needed.

**Note:** Abutment Screw EV should only be used clinically.

## Workflow - Atlantis® Abutment

The procedure sequence, as seen below, illustrates the different restorative stages and the products used and can be found throughout the manual for easy reference. The stage of the treatment procedure being reviewed is highlighted with a circle.

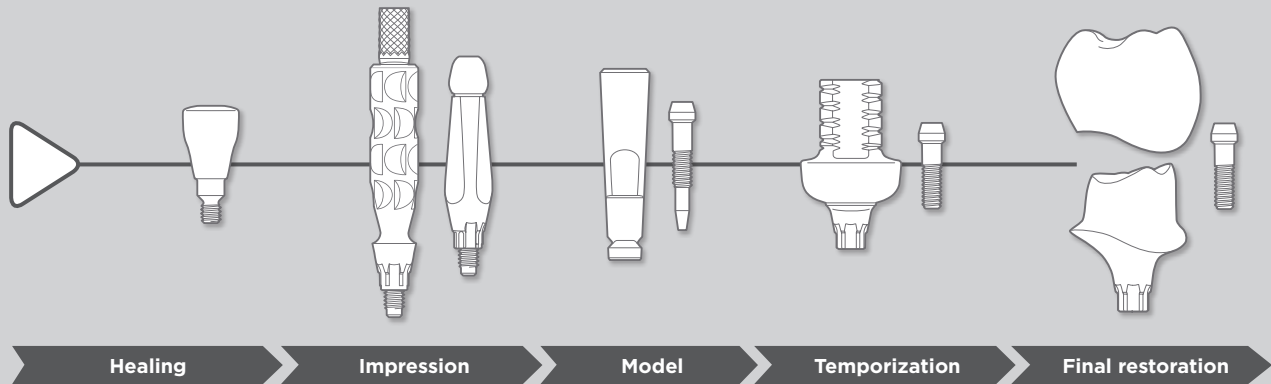

# Atlantis® Abutment

## Clinical application

- Single, partial and fully edentulous situations
- All positions in the mouth

**Note:** Use of zirconia abutments should be carefully evaluated when placed in situations with unfavorable loading conditions and in the molar region.

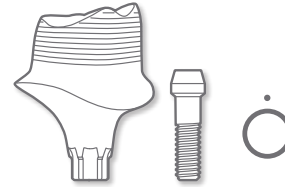

## Atlantis® Abutment

Atlantis Abutment will seat in one position only on OsseoSpeed EV implants.

By utilizing the unique Atlantis VAD (Virtual Atlantis Design) software, abutments are individually designed from the final crown shape and precision machined. Atlantis Abutments are available in titanium, gold-shaded titanium (TiN-coated) and zirconia. The abutment is designed and produced to provide function and esthetics, and further modifications are not recommended.

- Patient-specific abutments individually designed from the final tooth shape
- One-position-only seating on OsseoSpeed EV implants
- Abutment Screw EV is color coded according to the implant connection

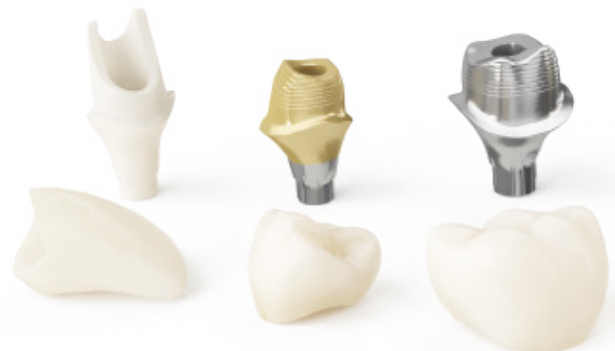

# Atlantis® Abutment

## Clinical procedure

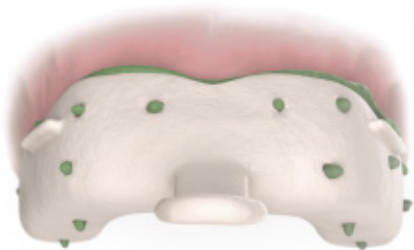

### Impression

- Take an implant-level impression using an open- or closed-tray technique.
- Send the impression to your laboratory with a request for Atlantis Abutments.

**Note:** It is also possible to use intraoral scanning to take a digital impression.

## Laboratory procedure

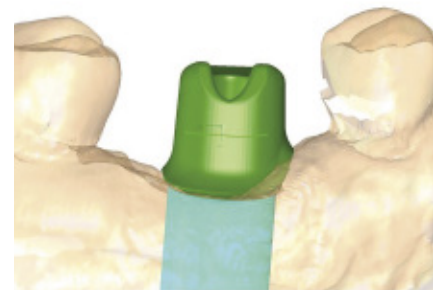

### Order Atlantis® Abutment

- Consult the separate Atlantis abutments design guide for detailed handling procedures in the laboratory.
- It is possible to either scan the model and send the file, or ship the model to the Atlantis production facility.
- Order an abutment for the appropriate OsseoSpeed EV implant by creating an order in Atlantis WebOrder - [www.atlantisweborder.com](http://www.atlantisweborder.com)

### Abutment design

- Atlantis Abutment designs can be reviewed and edited via Atlantis Editor before being approved for production.

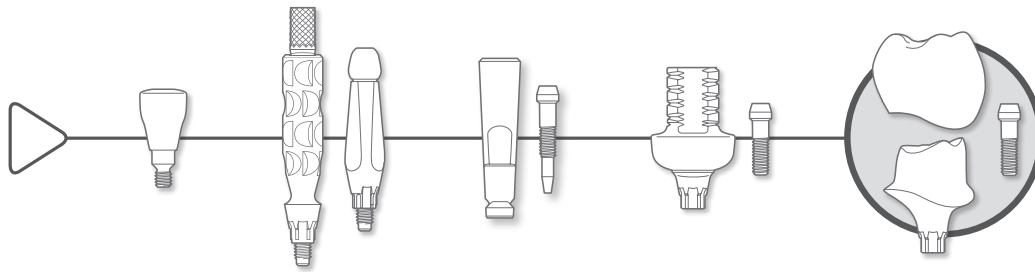

### Clinical procedure



#### Final restoration

- When the final Atlantis Abutment is received at the laboratory, the final restoration can be fabricated.

**Note:** The Abutment Screw EV delivered with the specific Atlantis Abutment should always be sent with the abutment to the clinician.

Lab Abutment Screw EV should be used pre-clinically in combination with Atlantis Abutments for the Astra Tech Implant System EV.

**Note:** Any modification may influence the mechanical strength of the abutment. For Atlantis Abutment in zirconia there is also a risk for change of material properties during e.g. grinding. Further modifications are not recommended.

#### Abutment installation

- Install the abutment with the abutment screw using the Hex Driver EV. The specific Abutment Screw EV delivered with the Atlantis Abutment should always be used.
- Use the Restorative Driver Handle together with the Hex Driver EV and Torque Wrench EV to tighten to the recommended torque (25 Ncm).

**Note:** Atlantis Abutments for OsseoSpeed EV will seat in one-position-only.



#### Cementation

- Cover the screw head before the screw channel is filled with a suitable material.
- Cement the crown onto the abutment and carefully remove all excess cement.
- Cementation technique should be adapted to the restoration of choice and according to the instructions from the manufacturer.
- Check the contact with adjacent teeth and make corrections to the occlusal relation as needed.

## Workflow - TiDesign™ EV/ZirDesign™ EV

The procedure sequence, as seen below, illustrates the different restorative stages and the products used and can be found throughout the manual for easy reference. The stage of the treatment procedure being reviewed is highlighted with a circle.

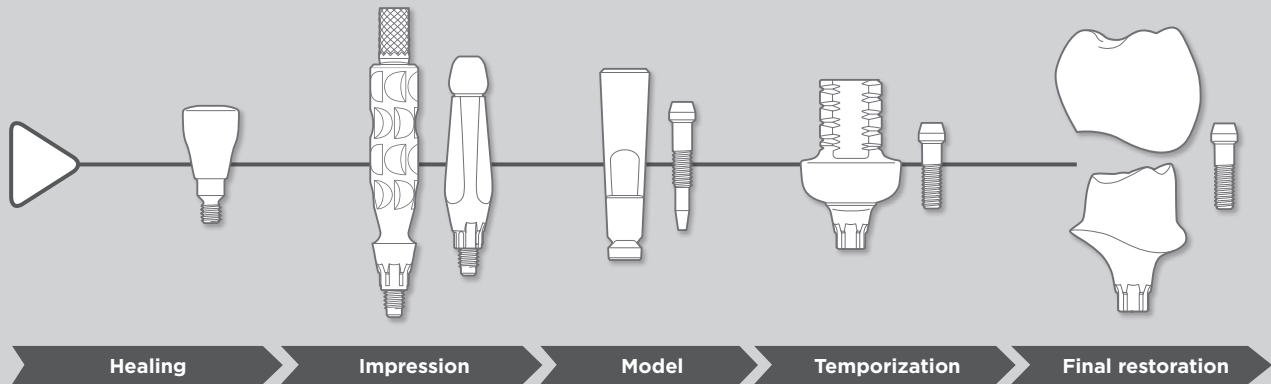



## TiDesign™ EV/ZirDesign™ EV

### Clinical application

- Single, partial and fully\* edentulous situations
- All\* positions in the mouth

\*Use of ZirDesign EV should be carefully evaluated in situations with unfavorable loading conditions and should not be used in the molar region.

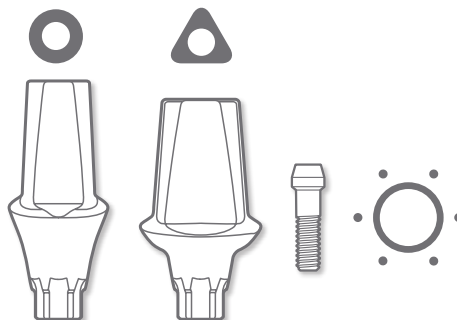

### TiDesign™ EV/ZirDesign™ EV

TiDesign EV and ZirDesign EV are two-piece anatomically pre-designed abutments. The design and dimensions are based upon the natural dentition utilizing a site-specific, crown-down approach. The round and triangular options mimic a variety of tooth shapes and are harmonized with the soft tissue sculpturing created by the corresponding healing abutment.

- Round - design for the majority of restorative situations
- Triangular - primarily for incisors and canines with distinct triangular shape
- Angled - for offset situations both in the anterior and posterior regions, compensating for implants in a restoratively unfavorable position
- Abutment Screw EV is color coded



## TiDesign™ EV/ ZirDesign™ EV

TiDesign EV and ZirDesign EV, the pre-designed abutments, are multi-indexed and fit in six available positions and have color-coded abutment screws according to implant-abutment connection.

### Laboratory procedure



#### Abutment selection

- Select and try out a suitable customizable abutment.

#### Instruments

- Mount the customizable abutment in a grinding handle with a separate Implant Replica EV and Lab Abutment Screw EV for safe and easy modification. Use grinders specially manufactured for the specific abutment material (see detailed handling procedure for abutments in section “Modification guidelines for TiDesign/ZirDesign”).

#### Further considerations

- The Lab Abutment Screw EV is developed exclusively for use with the Implant Replica EV. Clinical abutment screws should not be used in the laboratory.

**Note:** For chair side modification by the clinician, the lab abutment screw is also recommended together with the appropriate implant replica and a grinding handle to avoid intra-oral grinding.

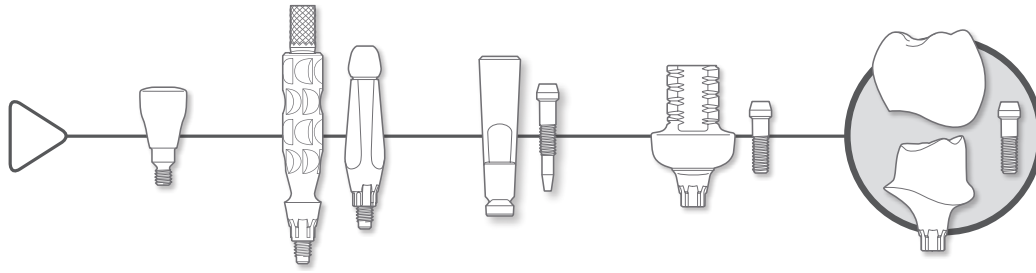

## Clinical procedure



### Removal of temporary restoration or healing abutment

- Before abutment installation, remove the healing abutment or the temporary restoration.

### Abutment installation

- The abutments have six possible placement options. Manually seat the abutment in the preferred index position before securing the abutment screw using the Hex Driver EV.
- Use the Restorative Driver Handle together with the Hex Driver EV and Torque Wrench EV to tighten to the recommended torque (25 Ncm).



### Cementation

- Cover the screw head before the screw channel is filled with a suitable material.
- Cement the crown onto the abutment and carefully remove all excess cement.
- Cementation technique should be adapted to the restoration of choice and according to the instructions from the manufacturer.
- Check the contact with adjacent teeth and make corrections to the occlusal relation as needed.

## Modification guideline – TiDesign™ EV

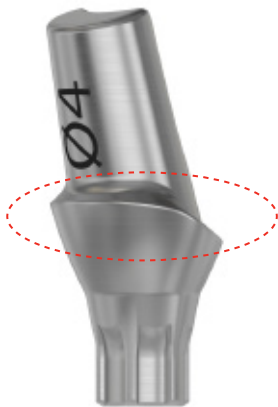
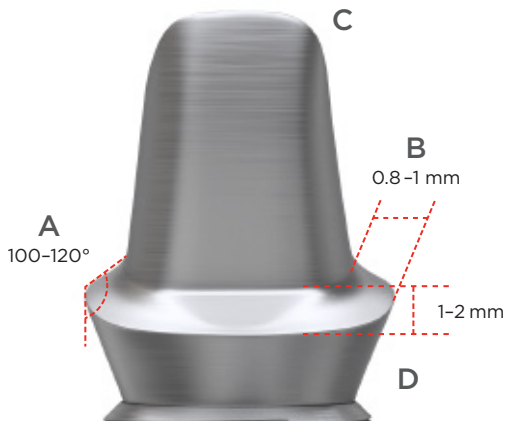
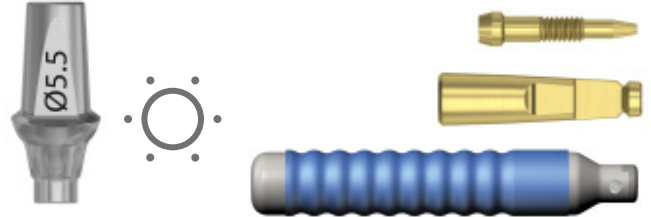

- Screw the abutment into an Implant Replica EV using the Lab Abutment Screw EV and mount into the Grinding Handle.
- Design the preparation with a shoulder or a chamfer to support the restoration adequately. Use grinders specifically manufactured for titanium.

**A.** When preparing for the final restoration, the shoulder or chamfer preparation should approximately range from 100-120°.

**B.** Maintain a margin shelf range of 0.8-1 mm.

**C.** Avoid sharp edges and corners to ensure a good fit between the abutment and the restoration.

**D.** Create the prosthetic margin just below the soft tissue level

- To ensure the strength of the TiDesign, maintain a minimum thickness of the remaining walls of at least 0.5 mm. Any inadvertent grinding below the final crown margin should be polished.

- Make sure not to damage the implant interface part of the abutment during modification of the abutment. A general recommendation is to stop reducing on the abutment 1 mm above the implant interface and avoid radical changes in that area.

**Note:** The angled TiDesign EV for 3.0 implants must be carefully modified with a minimum of reduction, especially at the base of the abutment pillar (see the red marked area).

## Modification guideline – ZirDesign™ EV

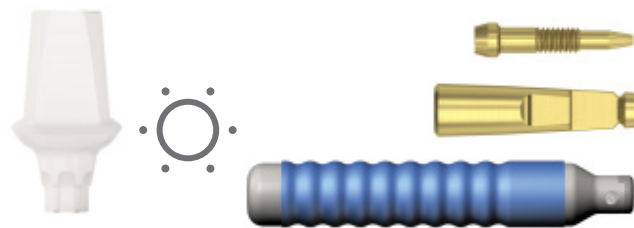
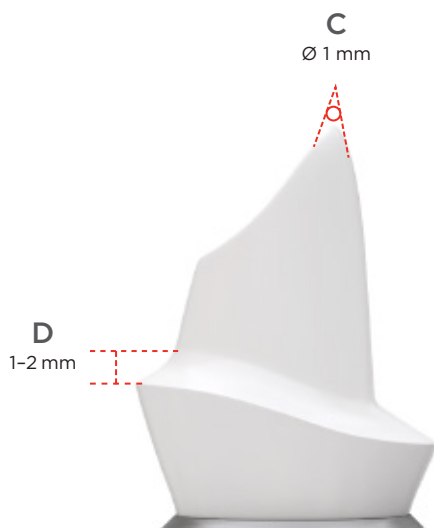

- Screw the abutment into an Implant Replica EV using the Lab Abutment Screw EV; mount in the Grinding Handle.
- Design the preparation with a shoulder or a chamfer to support the restoration adequately. Use grinders specifically manufactured for zirconia and always use water cooling.

**A.** When preparing for the final restoration, the shoulder or chamfer preparation should be between 100°-120° to support the crown.

**B.** Maintain a margin of 0.8-1 mm.

**C.** Avoid sharp edges and corners to ensure a good fit between the abutment and the restoration. Try to keep the edges rounded with a radius of 1 mm.

**D.** Create the prosthetic margin just below the soft tissue level.

- To ensure the strength and fit of the ZirDesign EV, maintain a minimum thickness of the remaining walls of at least 0.5 mm (except for the incisal area where it can be thinned out).

**Note:** Make sure not to damage the implant interface part of the abutment during modification of the abutment. A general recommendation is to stop reducing on the abutment 1 mm above the implant interface and avoid radical changes in that area. Any inadvertent grinding below the final margin should be polished, preferably using a silicon rubber wheel and diamond paste.

### Technical data

**Coefficient of thermal linear expansion:** 10.6 x 10<sup>-6</sup> K<sup>-1</sup>

**Bending strength:** 1000-1300 MPa

**Fracture toughness:** 9-10 MPa m<sup>1/2</sup>

**Modulus of elasticity:** 210 GPa

# Workflow – TitaniumBase EV

The procedure sequence, as seen below, illustrates the different restorative stages and the products used and can be found throughout the manual for easy reference.

The stage of the treatment procedure being reviewed is highlighted with a circle.

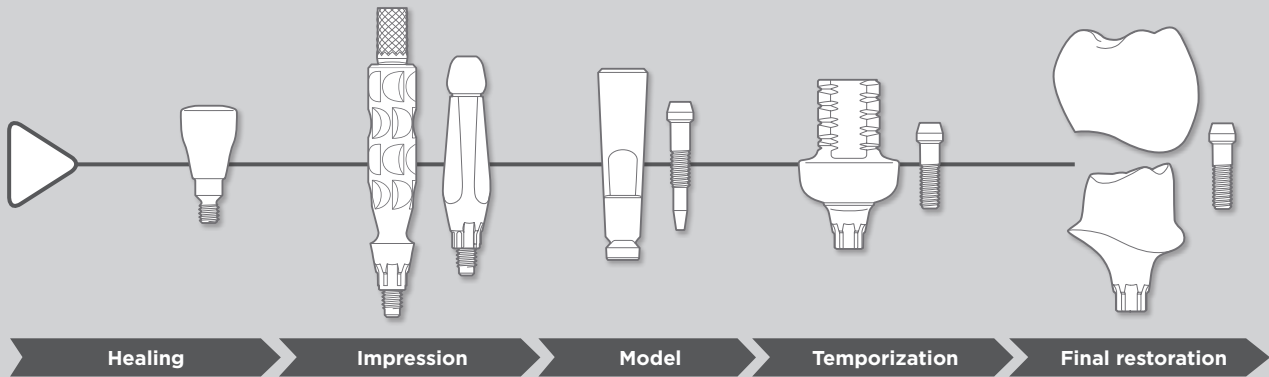

## Prepare for scanning

- Fabricate a model with the Implant Replica EV 4.8 with removable soft tissue mask.
- Remove the soft tissue mask.
- Place the appropriate Atlantis Lab FLO into the replica using the specific Lab FLO Screwdriver.

## Scan and design

- Scan the model with the lab FLO.
  - Design the ceramic part accordingly to the anatomical preferences.
  - Export the files of the designed ceramic part for milling process.
- Note:** 3Shape desktop scanner and TRIOS intraoral scanner can be used when working with TitaniumBase EV.

## Cementing

- Mount the TitaniumBase EV using the Lab Abutment Screw EV into the Implant Replica EV.
- Seal the screw access channel.
- Before cementing, prepare the surface.
- Make sure not to modify, blast or touch the conical part of the base.
- Cement the ceramic top onto the base. Cementing technique should be adapted to the restoration of choice and according to the instructions from the manufacturer.
- Remove all excess cement.

# TitaniumBase EV

## Clinical application

- Single and partial situations, all positions in the mouth
- For temporary and final cement- / screw-retained restorations
- Screw-retained restorations, limited to single-tooth only

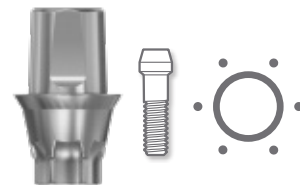

## TitaniumBase EV

TitaniumBase EV combines the proven strength of a prefabricated titanium abutment with the esthetics of an individually designed ceramic component. This solution allows the dental laboratory to design and manufacture a CAD/CAM restoration within their preferred workflow.

- TitaniumBase EV is provided with two flattened sides forming an anti-rotational feature
- Abutment Screw EV is color-coded



### Finalize the restoration

- Fabricate the crown.

**Note:** For cement-retained crown it is recommended to fabricate a transfer key to use at the installation.

### Abutment installation

- To ensure correct position, use a transfer key before final tightening of the abutment screw.
- Install the abutment with the ceramic top, use the Restorative Driver Handle EV together with the Hex Driver EV and Torque Wrench EV to tighten to the recommended torque (25 Ncm).

### Cementation

- Cement the final restoration on the abutment. Cementation technique should be adapted to the restoration of choice and according to the instructions from the manufacturer.
- Carefully remove all excess cement.
- Check contact with adjacent teeth and make corrections to the occlusal relation if needed.

## Workflow - CastDesign™ EV

The procedure sequence, as seen below, illustrates the different restorative stages and the products used and can be found throughout the manual for easy reference. The stage of the treatment procedure being reviewed is highlighted with a circle.

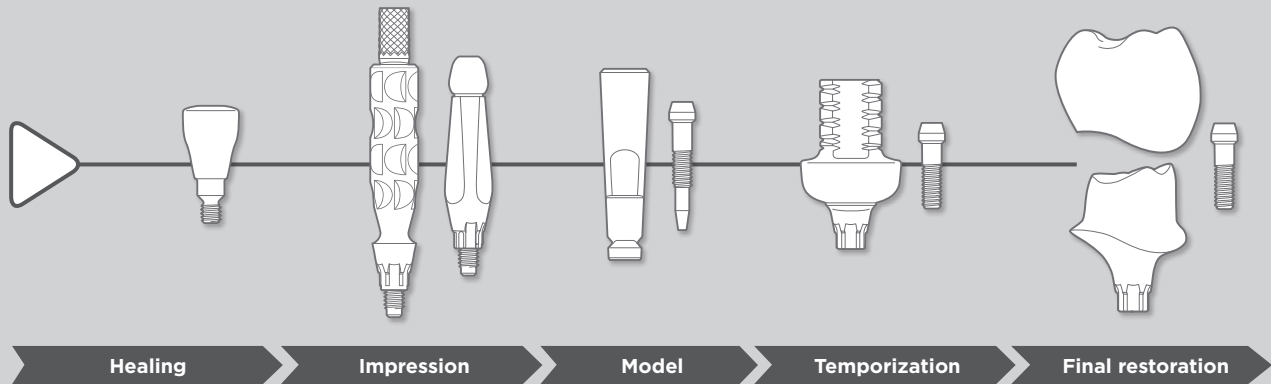



## CastDesign™ EV

### Clinical application

- Single, partial and fully edentulous situations
- All positions in the mouth
- Screw-retained restorations, limited to single-tooth only

**Note:** In cases where high biteforces are expected it is recommended to select a titanium abutment if possible. CastDesign EV should primarily be regarded as an abutment used when no titanium option is available.



### CastDesign™ EV

The CastDesign EV is a non-oxidizing high precious abutment modified at the laboratory. CastDesign EV is for fabrication of a customized abutment for cement-retained restorations, using regular wax-up and cast-to techniques.

- Can compensate for angulations up to 30°
- Abutment Screw EV is color-coded

**Note:** For screw-retained restoration, CastDesign EV shall be used for single-tooth applications only. Use of this product outside the listed indications will compromise the function of the Conical Seal Design and void the Dentsply Sirona implant warranty.



# CastDesign™ EV

The CastDesign EV is a non-oxidizing high precious abutment modified at the laboratory.

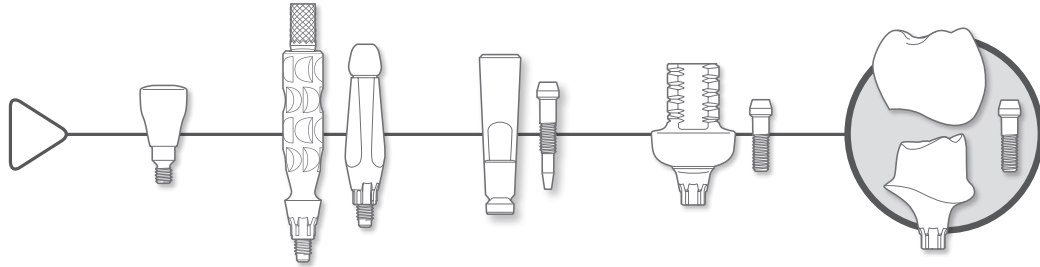

## Clinical procedure



### Removal of temporary restoration

- Before abutment installation, remove the healing abutment or the temporary restoration.

### Abutment installation

- The abutment has six possible placement options. Manually seat the abutment in the preferred index position before securing the abutment screw using the Hex Driver EV.
- Use the Restorative Driver Handle together with the Hex Driver EV and Torque Wrench EV to tighten to the recommended torque (25 Ncm).



### Cementation

- Cover the screw head before the screw channel is filled with a suitable material.
- Cement the crown onto the abutment and carefully remove all excess cement.
- Cementation technique should be adapted to the restoration of choice and according to the instructions from the manufacturer.
- Check the contact with adjacent teeth and make corrections to the occlusal relation if needed.

## Modification guideline – CastDesign™ EV



- The CastDesign EV is modified at the laboratory.
- The abutment can be prepared to compensate for angulations, as long as sufficient retention is present and loading conditions are non-critical.
- CastDesign abutment is first reduced and shaped in wax before the cast-to procedure.
- Check the wax-up for occlusal and mesial-distal clearance, ensuring there will be adequate crown material in all directions.
- Make sure the wax-up is thick enough to avoid a miscast. The margin is normally placed below the soft tissue margin.
- Do not remove the plastic around the metal cylinder-area. Invest the waxed abutment.
- Burnout and cast the abutment by using an alloy compatible with the CastDesign EV metal thermal expansion coefficient. Make sure the cast abutment including screw access hole is free from investment.

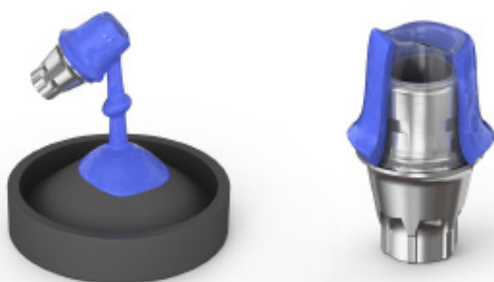
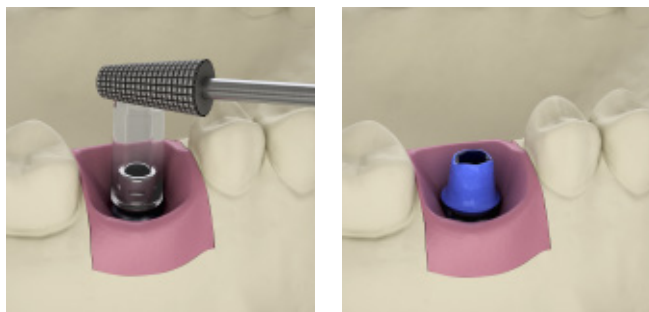

### Technical data

**Melting range:** 1400–1490°C/2552–2660°F

**Coefficient of thermal linear expansion for alloy:**  
25–500°C / 77–932°F 12.3 (10–6/°C) 25–600°C /  
77–1112°F 12.7 (10–6/°C)

**Base:** Non oxidizing gold alloy Au 60%, Pd 20%, Pt 19%, Ir 1%

**Cylinder:** PMMA burnout plastic

- Make sure not to damage the conical connection and the screw seat of the CastDesign EV abutment during blasting, not to violate the conical seal.
- Make sure to keep the screw seat surface unmodified, not to violate screw joint properties.

**Note:** CastDesign EV will absorb a lot of heat during burnout and casting. Make sure to compensate for this by increasing the period of time and temperature. Raise the temperature slowly to the final burnout temperature.

The cast-on alloy must have a casting temperature that is below the solidus (1400°C/2552°F) of CastDesign EV.

For the best possible results, please follow the guidelines below.

### Design

- Minimize the extended design from the center axis.
- Angulation must not exceed 30 degrees.
- Extended pillar height in combination with highly angled abutment must be carefully evaluated.
- Re-design of the margin should be avoided
- Do not modify or extend gold and/or porcelain onto the conical part of the abutment.
- It is not possible to apply porcelain directly to the high-precious alloy of the CastDesign EV.

### Handling

- Before investing the modified abutment, it is important to remove all excessive wax from the metal areas, which should not be modified. The metal should also be cleaned with acetone to ensure safe investing, thus minimizing the risk of air bubbles or unwanted casting errors.
- Investing and burnout time should follow the recommendations from the manufacturer of the investment material. The burnout time should be extended when plastic parts are included in the invested object.
- Investment material should be removed carefully and without modifying the surface configuration in the conical area, indexing part or the screw seat of the abutment.
- Blasting, grinding, cutting and polishing must not be done on the conical part, indexing part or the screw seat of the abutment.

## Workflow - Direct Abutment™ EV

The procedure sequence, as seen below, illustrates the different restorative stages and the products used and can be found throughout the manual for easy reference. The stage of the treatment procedure being reviewed is highlighted with a circle.

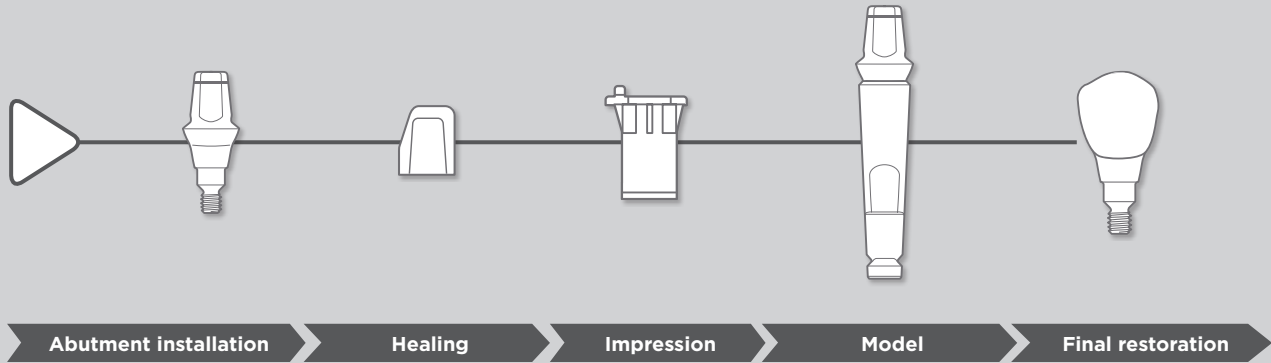

## Direct Abutment™ EV Direct EV API™

### Clinical application

- Single, partial and fully edentulous situations
- All positions in the mouth



### Direct Abutment™

Direct Abutment EV is a one-piece abutment designed to meet the clinicians' demands for conventional crown and bridge procedures and restorative simplicity. They are available in different diameters and heights, mimicking preparations of natural teeth.

- Delivered sterile

### Direct EV API™

All necessary components for the restorative and laboratory procedures, including pick-up, healing cap, replica and burnout cap, are delivered in a Direct EV API kit, consisting of one clinical and one laboratory container.

- Delivered non-sterile

#### Clinic

- Direct Abutment EV Heal Cap: Polycarbonate plastic
- Direct Abutment EV Pick-Up: Polypropylene plastic

#### Laboratory

- Direct Abutment EV Replica: Titanium Alloy
- Direct Abutment EV Burnout Cap: PMMA Burnout plastic



Clinic

Laboratory



# Direct Abutment™ EV

Direct Abutment EV is a one-piece abutment designed to meet the clinicians' demands for conventional crown and bridge procedures and restorative simplicity.

## Clinical procedure



### Pick up

- Pick up the sterile Direct Abutment EV Ø 5 and 6, using the Hex Driver, or the Direct Driver EV Ø 3.3 Ø 4 for Direct Abutment EV Ø 3.3 and 4\*.

\* Installation of Direct Abutment EV Ø 3.3 and Ø 4 with Direct Driver EV Ø 3.3 Ø 4 – aim the arrow on the driver towards the flat surface on the abutment and press the driver onto the abutment.

### Abutment installation

- Install the abutment using one of the drivers with Restorative Driver Handle and the Torque Wrench EV to tighten to the recommended torque (25 Ncm).



### Healing and temporization

- Direct Abutment EV HealCap is used as a provisional solution, either as is, or as a base for building a temporary restoration.
- Snap the heal cap onto Direct Abutment EV. For proper retention, use temporary cement.
- Make sure that the cap is seated all the way down on the abutment.

**Note:** The heal cap bonds chemically to acrylics and composite.

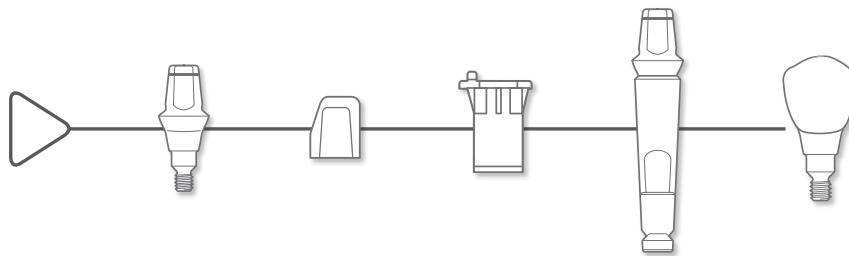

## Laboratory procedure

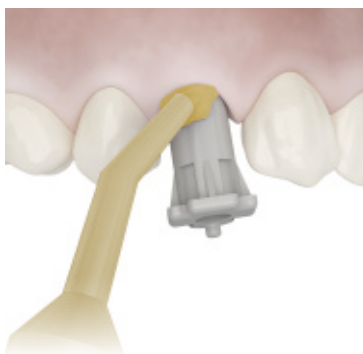

### Impression procedure – closed tray

- Select the appropriate Direct Abutment EV Pick-up.
- Align the flat surface of the abutment with the knob on pick-up. Seat it firmly, allowing it to snap into place.
- Use a closed tray impression technique.
- Inject elastomeric impression material around the pick-up and in the tray and take the impression. Once the impression material has set, remove the impression from the mouth.
- Check the impression for correct and stable retention and send to the laboratory.

#### Note:

- It is recommended to autoclave the Direct Abutment EV Pick-Up before use.
- All Direct Abutment EV products are single-use.

### Working model

- Align the flat surface of Direct Abutment EV Replica with Direct Abutment EV Pick-up and seat in the correct position until it snaps.
- Fabricate a high quality stone model with a removable soft tissue mask.

#### Note:

- If a removable abutment replica is preferred, cut off the “coin” on the replica apex and smooth the cut surface area to avoid any damage to the master model.
- Use of several different removable replicas in one master model may increase the risk of incorrect repositioning.
- Make sure the replica is correctly re-seated all the way down in the unique one-position in the master model if using the removable replica feature.

### Burn out procedure

- Align the flat surface of the replica with the “chimney” of Direct Abutment EV Burnout Cap.
- The Burnout Cap has a built-in cement space. Do not burnout the wax and plastic too quickly, which may create defects in the investment material/casting.

### Crown fabrication

- Manufacture the final restoration according to general restorative principles.

# Direct Abutment™ EV

## Clinical procedure



### Final installation

- Cement the crown onto the abutment.
- Cementation technique should be adapted to the restoration of choice and according to the instructions from the manufacturer.

**Note:** All Direct Abutment EV products are single-use.

### Final result

- Carefully remove all excess cement.
- Check contact with adjacent teeth and make corrections to the occlusal relation as needed.



## Modification guideline – Direct Abutment™ EV

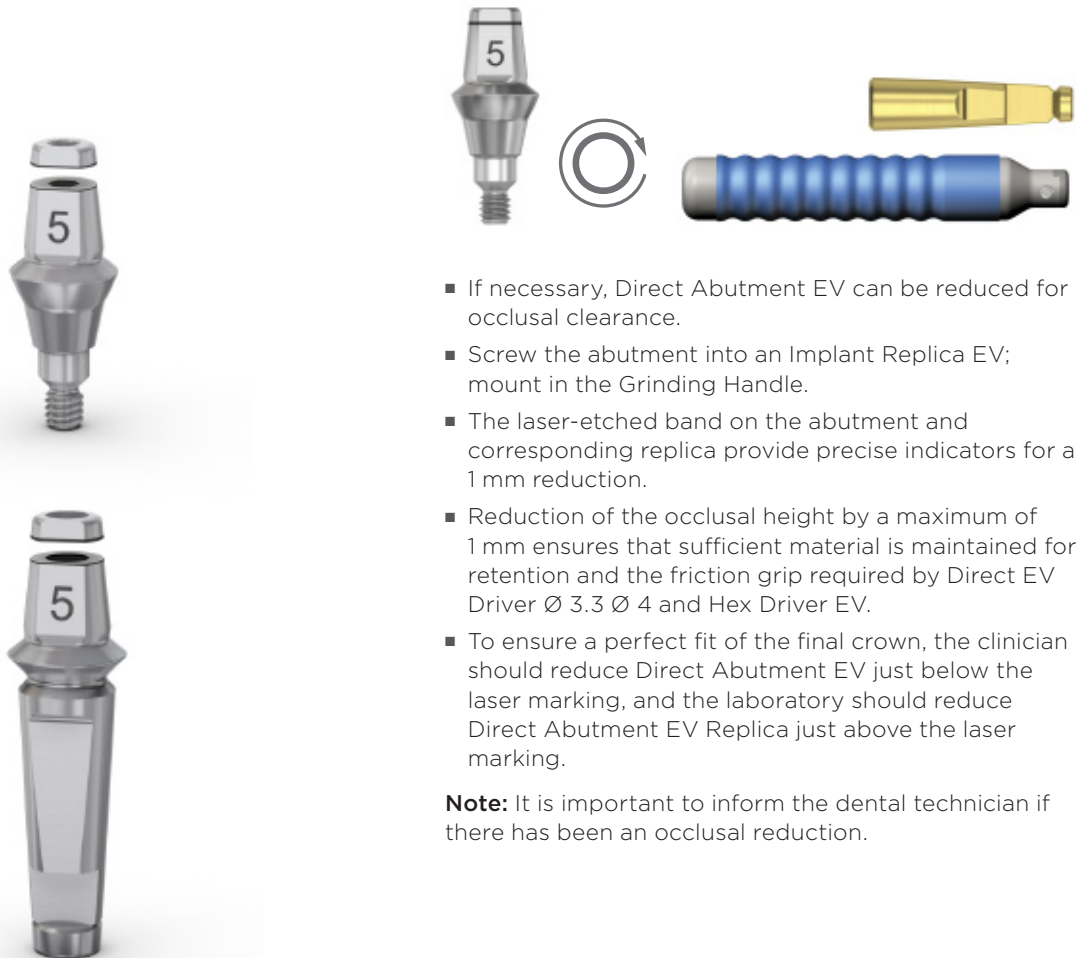

- If necessary, Direct Abutment EV can be reduced for occlusal clearance.
- Screw the abutment into an Implant Replica EV; mount in the Grinding Handle.
- The laser-etched band on the abutment and corresponding replica provide precise indicators for a 1 mm reduction.
- Reduction of the occlusal height by a maximum of 1 mm ensures that sufficient material is maintained for retention and the friction grip required by Direct EV Driver Ø 3.3 Ø 4 and Hex Driver EV.
- To ensure a perfect fit of the final crown, the clinician should reduce Direct Abutment EV just below the laser marking, and the laboratory should reduce Direct Abutment EV Replica just above the laser marking.

**Note:** It is important to inform the dental technician if there has been an occlusal reduction.

# Torque Wrench EV – restorative handling

A torque wrench together with a Restorative Driver Handle are used to tighten abutment screws and/or bridge screws.

When used together with the Surgical Driver Handle, the torque wrench can also be used for implant installation and adjustment.

## Prosthetic instruments

Prosthetic instruments specifically designed for the Astra Tech Implant System EV.

- Hex Driver EV, manual and machine
- Direct Driver EV Ø 3.3 Ø 4, machine
- Torque Wrench EV
- Torque Wrench EV Restorative Driver Handle
- Torque Wrench EV Restorative Driver Handle Low



### Assemble

- Assemble the head of the wrench and the body by pushing the components together and turning them in opposite directions until there is an audible click.

### Attach

- Attach the Hex Driver EV into the Restorative Driver Handle and then into the wrench until there is an audible click.

### Handling

- Use a finger on the top of the driver handle to keep it steady and in place. Then gently pull the arm of the torque wrench in the direction of the arrow until the desired torque is achieved.

**Note:** The arm of the torque wrench must not go beyond the end of the scale, as this could result in inaccurate torque readings.

The arrow on the head of the wrench shows the direction in which the wrench is functioning.





### Disassemble

- Remove the driver handle from the wrench.
- Remove the head by pressing a finger into the recess (1) and gently pulling the head (2).











### Cleaning and drying

- The three separated parts are now ready for cleaning using water and a brush. Let the parts dry.















### Sterilization

- Follow the manufacturer's instructions for use.

## Torque guide – Recommended installation and tightening torque

Type of product installation		Torque – Ncm
<ul style="list-style-type: none"> <li>Implant installations</li> </ul>		Maximum 45 Ncm
<ul style="list-style-type: none"> <li>Cover screws</li> <li>Healing components</li> </ul>	  	5-10 Ncm Manual/ light finger force
<ul style="list-style-type: none"> <li>Temporary abutments</li> <li>Temporary restorations on all levels</li> </ul>	 	15 Ncm
<ul style="list-style-type: none"> <li>Final abutments</li> <li>Single tooth restorations on implant level</li> </ul>	  	25 Ncm
<ul style="list-style-type: none"> <li>Final restorations on abutment level</li> </ul>	 	15 Ncm

## Explanation of the symbols on labels and instructions for use

	Date of manufacture.		Do not re-use, Single use only.		Do not use if package is damaged.
	Legal manufacturer.		Do not re-sterilize.		Consult instructions for use.*
	Expired date.		GOST is the valid quality certification system in Russian Federation.		LOT/BATCH number.
	Sterilized using irradiation.		Products carrying the CE mark fulfill the requirements of the Medical Device Directive.		Article number.
	<b>Caution:</b> Federal (USA) law restricts this product to sale by or on a order of a dentist.		Identification of Notified Body.		Contains article number (GTIN number), lot number and quantity.
	The product is not sterile.				

\* To read PDF files you will need Adobe Reader. Download free of charge at [get.adobe.com/reader](http://get.adobe.com/reader).

# Cleaning and sterilization instructions

Products within Astra Tech Implant System EV are designed to be cleaned and sterilized before clinical use with the exception of sterile products. Please follow the instructions stated in the Cleaning and sterilization instructions for Astra Tech Implant System EV.

The cleaning and sterilization instructions for Astra Tech Implant System EV assortment has been developed and validated by Dentsply Sirona. The instructions have been developed in accordance with the applicable standards.



Cleaning and sterilization instructions for Astra Tech Implant System EV – 32671332





## About Dentsply Sirona Implants

Dentsply Sirona Implants offers comprehensive solutions for all phases of implant therapy, including Ankylos®, Astra Tech Implant System® and Xive® implant lines, digital technologies, such as Atlantis® patient-specific solutions and Simplant® guided surgery, Symbios® regenerative solutions, and professional and business development programs, such as STEPPS™. Dentsply Sirona Implants creates value for dental professionals and allows for predictable and lasting implant treatment outcomes, resulting in enhanced quality of life for patients.

## About Dentsply Sirona

Dentsply Sirona is the world's largest manufacturer of professional dental products and technologies, with a 130-year history of innovation and service to the dental industry and patients worldwide. Dentsply Sirona develops, manufactures, and markets a comprehensive solutions offering including dental and oral health products as well as other consumable medical devices under a strong portfolio of world class brands. As The Dental Solutions Company™, Dentsply Sirona's products provide innovative, high-quality and effective solutions to advance patient care and deliver better, safer and faster dentistry. Dentsply Sirona's global headquarters is located in York, Pennsylvania, and the international headquarters is based in Salzburg, Austria. The company's shares are listed in the United States on NASDAQ under the symbol XRAY.

Visit [www.dentsplysirona.com](http://www.dentsplysirona.com) for more information about Dentsply Sirona and its products.