



DS Implants

EV Prosthetics manual

DS PrimeTaper™

Astra Tech Implant System® EV

This manual is designed for use by clinicians who have undergone at least basic prosthetic and in-clinic implant training. Staying current on the latest trends and treatment techniques in implant dentistry through continued education is the responsibility of the clinician.

All products may not be regulatory cleared/released/licensed in all markets. Please contact the local Dentsply Sirona sales office for current product assortment and availability.

To improve readability for our customers, Dentsply Sirona does not use ® or ™ in body copy. However, Dentsply Sirona does not waive any right to the trademark and nothing herein shall be interpreted to the contrary.

Product illustrations are not to scale.

CONTENTS

1. Introduction to the prosthetic assortment

Color coding	4
Prosthetic procedures	5
Implant-abutment connection	5
Recommended torques	6
Torque guide - Recommended installation and tightening torque	6

2. Treatment planning

Conventional treatment planning	7
Computer-guided treatment planning	7

3. Introduction to Atlantis patient-specific restorations

Cement-retained restorations	8
Screw-retained restorations	9
Attachment-retained restorations	10

4. Impression procedures

Digital impressions - Intraoral scanning	11
Conventional impressions - model scanning or analog procedure	12
Implant level impression	13
Implant Pick-Up	13
Implant Transfer	14
Implant Analog	15

5. Cement-retained restorations

Abutment overview	16
Temporary restoration procedures	17
TempAbutment EV	17
Final restoration procedures	19
TiDesign EV	19
TitaniumBase EV	20
CastDesign EV	21

6. Screw-retained restorations

Abutment overview	23
Temporary restoration procedures	24
TempAbutment EV	24
Final restoration procedures	25
MultiBase Abutment EV	25
Straight abutment connection	25
30° abutment connection	26
Pick-Up	27
Analog	28
Temporary cylinder	29
Semi-Burnout cylinder	31
CastDesign EV	33
TitaniumBase EV	34

7. Appendix

SmartFix concept	36
Acuris conometric concept	36
WeldOne concept	36
Cleaning and sterilization instructions	36
Torque Wrench EV	37
Modification guidelines	38
TiDesign EV	38
CastDesign EV	39

1. Introduction to the prosthetic assortment

Color coding

Throughout the prosthetic assortment, markings, color coding and geometrical designs simplify the correct identification of the corresponding components.

Each implant-abutment connection size is identified by a specific color. The color is applied directly to components and instruments, as well as on packaging and information materials.

Stock components and their respective packagings are color coded:

PrimeTaper EV	Ø3.0 mm*	Ø3.6 mm	Ø4.2 mm	Ø4.8 mm	Ø5.4 mm
Connections		S	M	L	L

Astra Tech Implant EV	Ø3.0 mm	Ø3.6 mm	Ø4.2 mm	Ø4.8 mm	Ø5.4 mm
Ø mm	3.0	3.6	4.2	4.8	5.4
	↕	↕	↕	↕	↕
Connections	XS	S	M	L	XL

* Not yet available for PrimeTaper EV.



Prosthetic procedures

The following chapters provide detailed descriptions of prosthetic procedures on implants with EV connection. Restorations can be built from implant or abutment level. The abutment shall support a functional tooth replacement and minimize the risk of overload by reducing forces transferred to the implant.

Consider the following when selecting an abutment:

- Clinical application — single, partial or fully edentulous situations
- Type of restoration - technique and material
- Implant-level or abutment-level impression technique
- Anterior or posterior location
- Esthetic demands
- Implant angulations
- Tissue conditions
- Occlusal and interproximal space
- Adjacent teeth

Orientation

The sequence, as seen below, illustrates the different restorative stages. The stage of the treatment procedure that is described is highlighted in yellow.



Implant-abutment connection

The implants have a unique interface providing three different options for abutment placement/indexing.



Abutment placement/indexing options

One-position-only

Atlantis patient-specific abutments will only seat in one position.



Six positions

Indexed abutments will seat in six available positions.



Non-indexed

Non-indexed abutments will be seated in any rotational position.



Recommended torques



All final abutments are designed for a uniform torque, 25 Ncm.

Due to clinical considerations, the temporary abutments have been verified for a lower torque, 15 Ncm.

A lower torque, 15 Ncm, is also used for bridge screws.

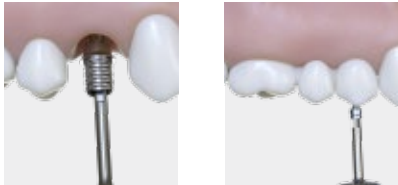
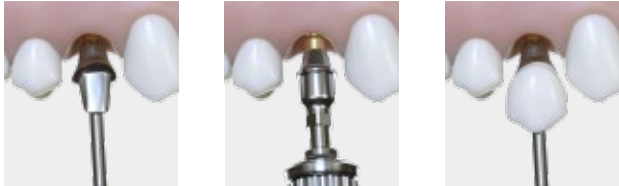

Torque guide - Recommended installation and tightening torque

Type of product installation	Torque - Ncm
<ul style="list-style-type: none"> ■ Temporary abutments ■ Temporary restorations on all levels 	 <p style="text-align: center;">15 Ncm</p>
<ul style="list-style-type: none"> ■ Final abutments ■ Single-tooth restorations on implant level 	 <p style="text-align: center;">25 Ncm</p>
<ul style="list-style-type: none"> ■ Final restorations on abutment level 	 <p style="text-align: center;">15 Ncm</p>

2. Treatment planning

Pre-operative planning should be based on the expected restorative treatment outcome. Therefore treatment planning should include all stages of the procedure, from healing time and components to temporary and final restorations.

The treatment planning is based on a comprehensive consultation with the patient to determine exactly what the patient wants and expects from the treatment, but also to discover any possible contraindications and to explain the treatment in detail to the patient.

It is followed by a complete general and specific medical history and intraoral examination with analysis of the initial anatomical situation.

The following points must be considered:

- Medical and dental history
- General diagnoses – exclusion of contraindications
- Specialist consultation for risk factors
- Detailed intraoral examination including general radiographic examination

After examination and evaluation of the diagnostic documentation, the treatment plan should be prepared.

Even though the final treatment approach may be determined at the time of surgery, consider the following based on the quality of supporting bone and expected initial stability of the implant(s):

- One- or two-stage surgical procedure
- Immediate or early loading protocol
- Expected healing time before loading

When determining time to loading of implants for each individual case, the following should be carefully examined and assessed:

- Bone quality and quantity
- Primary stability
- Design of restoration
- Loading conditions

Before treatment begins, the patient should be informed about the results of the pre-operative examination and given a clear explanation of what the planned treatment entails, including the expected outcome, maintenance requirements and risks involved.

Accurate planning of every implant procedure is essential for the long-term success of the treatment. The planning process defines all actions and lists alternatives that can meet the patient's expectations of the function and esthetics of the implant-prosthetic rehabilitation.

Conventional treatment planning

A diagnostic wax-up with the missing teeth replaced provides important information in the planning phase.

Based on analysis and evaluation of the occlusal table, force distribution and preferred sites for the implants, an optimal plan can be achieved.

The diagnostic wax-up and radiographs make it possible to plan implant position, angulation and size in order to support the planned prosthetic construction in an optimal way.

A surgical guide can be manufactured and used during surgery to aid the implant installation.

Computer-guided treatment planning

Digital treatment planning based on three-dimensional imaging procedures enables the therapy to be planned with accuracy and makes the implant placement procedure predictable and precise. Guided Surgery from DS, based on the Simplant software, offers a complete solution for digital treatment planning and guided implant placement. A custom-made Simplant SAFE guide is fabricated using the digital planning data. This guarantees that the planning will be fully and accurately transferred to the patient's mouth.

3. Introduction to Atlantis patient-specific restorations

As part of the digital implant solutions offered by Dentsply Sirona, Atlantis delivers patient-specific prosthetic solutions for all major implant systems* providing an excellent foundation for optimal function and esthetics.

By utilizing the unique design software, suprastructures, abutments and crowns will be individually designed from the final tooth shape. This is a significant advantage for achieving a more natural, esthetic result and optimized function.

Choose from completely or partially outsourced restorative procedures. Atlantis connects easily to preferred clinical and dental laboratory digital workflows.

The Atlantis Core File for Atlantis Abutments or Atlantis BridgeBase gives an easy and fast way for in-house designing and manufacturing of the crown or bridge before the abutment or suprastructure is delivered. Also the possibility to order an Atlantis printed model for your Atlantis abutments.

More information about Atlantis solutions can be found at <https://www.dentsplysirona.com/implantology>

*Refer to Atlantis implant compatibility charts.

Cement-retained restoration

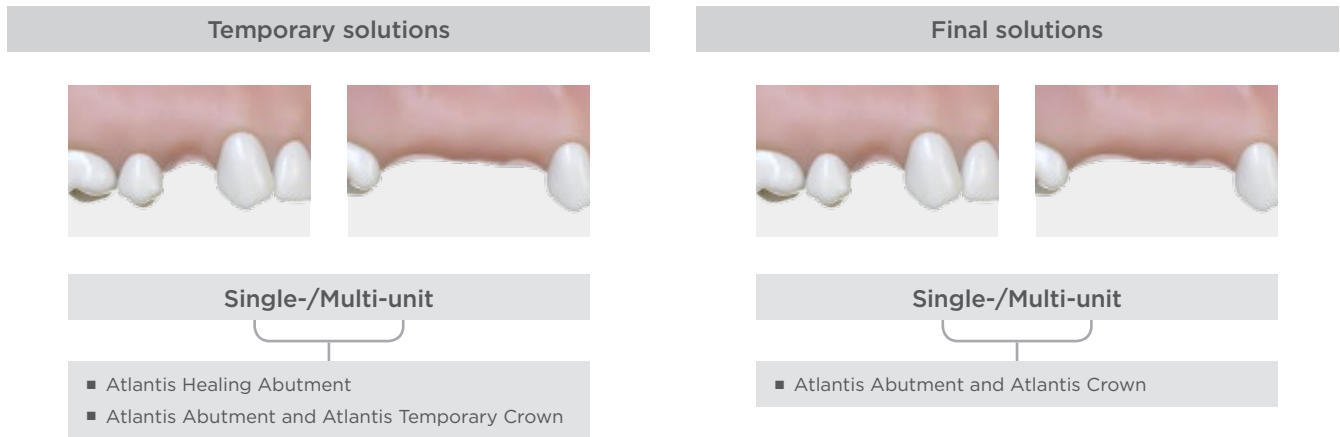





Temporary restorations - Single-/Multi-unit		Features
Atlantis Healing Abutment Titanium Gold-shaded titanium		Patient-specific abutments are designed and based on the planned final Atlantis Abutment and crown. By using the same emergence profile, an esthetic outcome during the soft-tissue healing phase is more easily achieved.
Atlantis Abutment and Temporary Crown Titanium Gold-shaded titanium		Atlantis Abutment and Atlantis Temporary Crown (PMMA) or digital files for in-house production of temporary crowns or bridges. Works as a functional, cement-retained restoration, up to 12 months, until a permanent crown is constructed.
Final restorations - Single/Multi-unit		Features
Atlantis Abutment and Atlantis Crown Titanium Gold-shaded titanium Zirconia		Atlantis Abutment and an Atlantis Crown or digital files for in-house production of crowns or bridges. Zirconia abutments are delivered with a mandatory Atlantis insertion guide. Atlantis Crown available in Cercon xt ML, extra translucent multilayer zirconia.

Screw-retained restoration



Temporary restorations		Features
Atlantis Healing Abutment Titanium Gold-shaded titanium		Patient-specific abutments are designed and based on the planned final Atlantis Abutment and crown. By using the same emergence profile, an esthetic outcome during the soft-tissue healing phase is more easily achieved.
Atlantis CustomBase Solution Atlantis Abutment and Atlantis Temporary Crown Titanium Gold-shaded titanium		Atlantis Abutment and Atlantis Temporary Crown (PMMA) or digital files for in-house production of temporary crowns. Works as a functional, screw-retained restoration, up to 12 months, until a permanent crown is constructed. For extraoral cementation only. Atlantis Angulated Screw Access Screwdriver is required during installation.
Final restorations – Single-unit		Features
Atlantis CustomBase Solution Atlantis Abutment and Atlantis Crown Titanium Gold-shaded titanium		Patient-specific dental prosthetic components consisting of an Atlantis Abutment with an Atlantis Crown or digital files for in-house production of crowns. Angulated screw access feature allows the screw access hole to be optimal positioned, thereby improving the esthetics and the installation procedure. For extraoral cementation only. Atlantis Angulated Screw Access Screwdriver is required during installation.
Atlantis Crown Abutment Titanium Zirconia		Patient-specific abutments, individually designed from the final tooth shape, for direct porcelain application (or composite for titanium). Available in titanium and five shades of zirconia including a translucent zirconia in white.
Final restorations – Multi-unit		Features
Atlantis BridgeBase Titanium AM		Atlantis BridgeBase comes with digital files for in-house production of a secondary structure in esthetical material of your choice. The design has no undercuts and a cement shoulder line. Angulated screw access feature allows the screw access hole to be optimal positioned, thereby improving the esthetics. Structure is produced by additive manufacturing and corrective milling on connection level.
Atlantis Bridge Titanium AM Cobalt-chrome AM		Designed for porcelain or composite applications. The design allows for individual space for veneering material and surface structure. Angulated screw access feature allows the screw access hole to be optimal positioned, thereby improving the esthetics. Structure is produced by additive manufacturing and corrective milling on connection level.
Atlantis Hybrid Titanium AM Cobalt-chrome AM		Commonly used for acrylic denture teeth with individual support for each tooth, as a “wrap-around” or a “wrap-on”. Angulated screw access feature allows the screw access hole to be optimal positioned, thereby improving the esthetics. Structure is produced by additive manufacturing and corrective milling on connection level.

Attachment-retained restorations

Final restorations		Features
Atlantis Conus Abutment, Overdenture Titanium		Utilizing a friction fit. Parallel, one-size abutments for removable prostheses, designed to fit SynCone 5° caps. Is delivered with a mandatory Atlantis insertion guide.
Atlantis Conus Abutment, Custom Titanium Gold-shaded titanium		For attachment-retained restorations utilizing a friction fit. Enabling more individual design options. These abutments are more individualized than the overdenture abutments and will therefore not have a pre-set shape (will not fit with SynCone caps).
Atlantis Bar Titanium Cobalt-chrome		Standard or custom bars. A wide range of attachments and bar profiles is available. Made by milling.
Atlantis 2in1 Titanium Cobalt-chrome		The primary structure is a custom bar and the secondary structure can either be a bridge or a hybrid. The secondary structures are suitable for a composite layering (bridge) or using acrylic denture teeth with individual support for each tooth (hybrids). Made by milling.

4. Impression procedures

Depending on the impression technique used, different restoration options are available. Follow the guide below to see the restoration options when using digital impressions or conventional impressions.

Digital impressions - intraoral scanning

Digital dentistry makes impressions more accurate. It is also a faster and more convenient technique to use. Implant/abutment level digital impression is taken by the restorative clinician using an intraoral scanner. It is important to use the correct scan body and follow the scanning strategy for the planned restorative procedure.

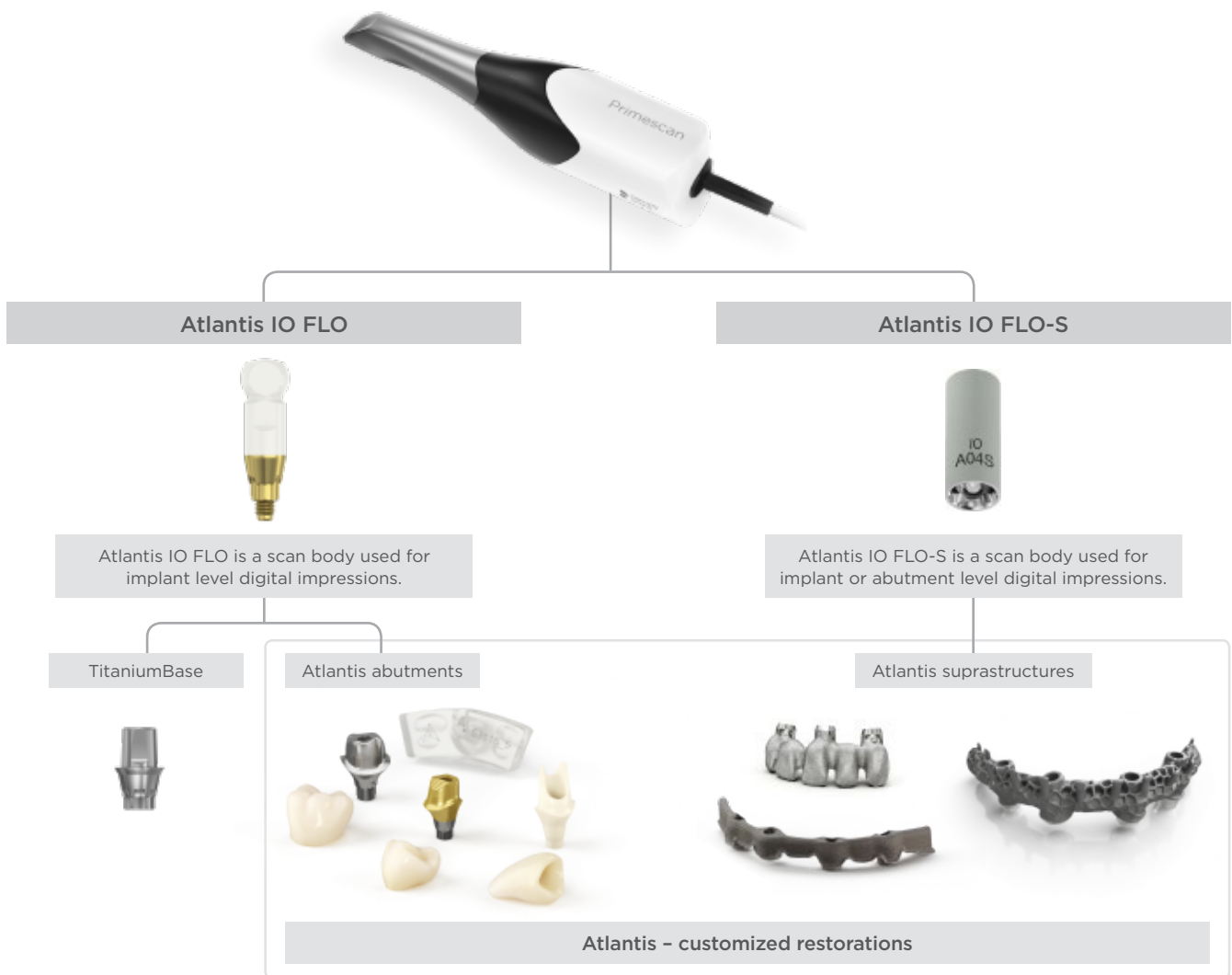

Conventional impressions – model scanning or analog procedure

The restorative clinician takes a conventional impression and sends the case to a partnering laboratory. The dental technician either scans the model to make it digital or continues with the restoration in a fully analog way. It is important to use the correct scan body and follow the model scanning instructions for the planned restorative procedure.

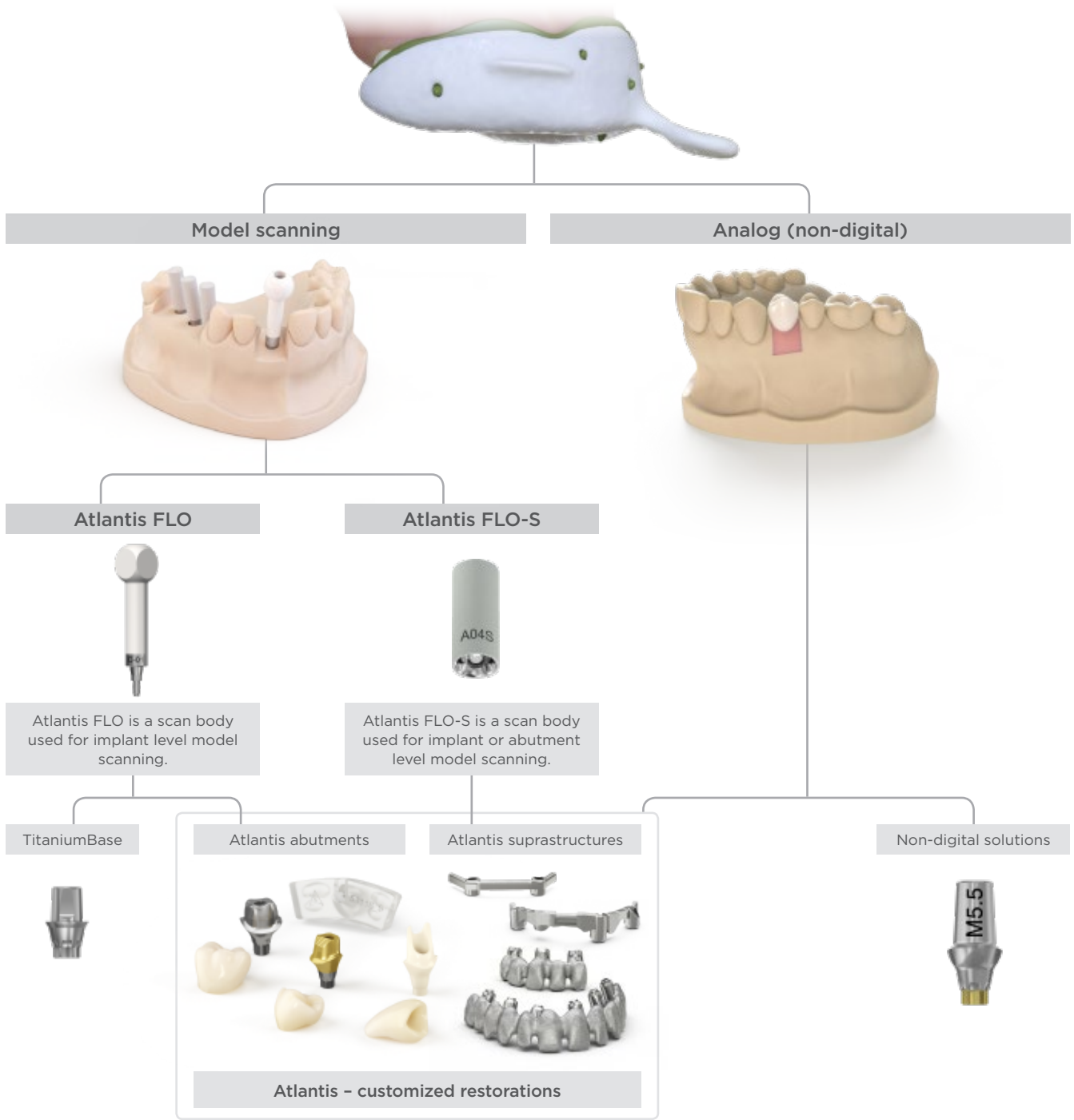

Implant level impression

Implant Pick-Up EV Design

Implant pick-ups are used for open-tray impression procedures. The design supports different preferred techniques for capturing the anatomy of the soft tissue.



Implant Pick-Up EV Design

- Titanium
- Self-guiding impression component; only engages into the implant when correctly seated
- One-hand procedure
- Supports all indexing options; one-position-only, six position and non-indexed
- Integrated pin for safe handling
- Designed for splinting possibilities
- Color coded

Clinical procedure - open tray



- 1 ■ Prepare and use a standard or customized open impression tray.

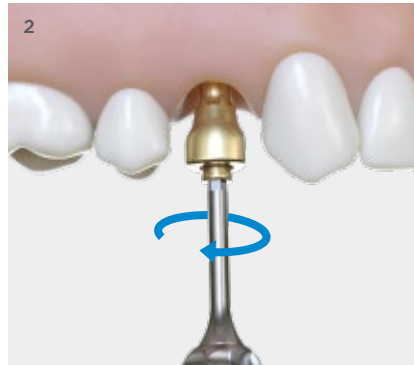

- 2 ■ Remove the healing component and check implant stability.

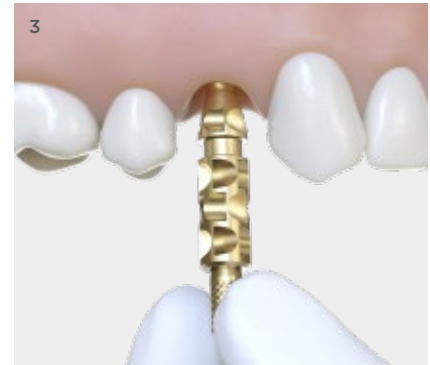

- 3 ■ Select a pick-up of suitable length.
- Connect the pick-up to the implant manually.

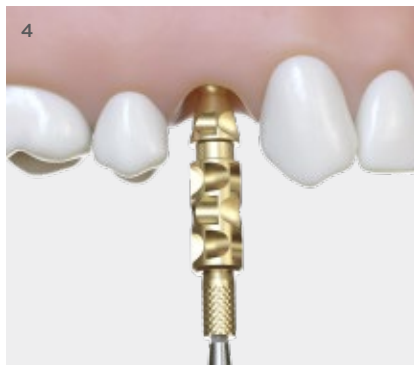

- 4 ■ Secure the implant pick-up with manual tightening torque, 5-10 Ncm, using the hex driver.

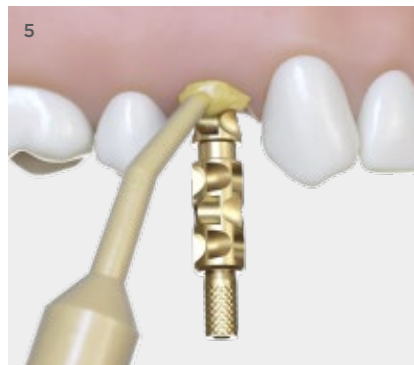

- 5 ■ Apply impression material around the pick-up, followed by filling of the tray.
- Take the impression.

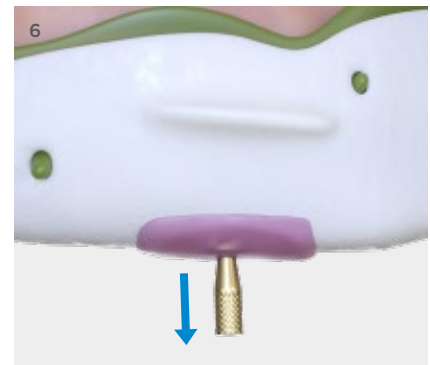

- 6 ■ Once the impression material has set, unscrew the pin and remove the impression.
- Before removing the impression, make sure that the pin is completely disengaged from the implant.
- Check the impression for correct and stable retention of the pick-up.

Implant Transfer EV

Implant transfers are used for closed-tray impression procedures.



Implant Transfer EV

- Titanium
- Self-guiding impression component; only engages into the implant when correctly seated
- One-hand procedure
- Supports all indexing options; one-position-only, six positions and non-indexed
- Color coded

Clinical procedure – closed tray



- Prepare and use a standard or customized closed impression tray.

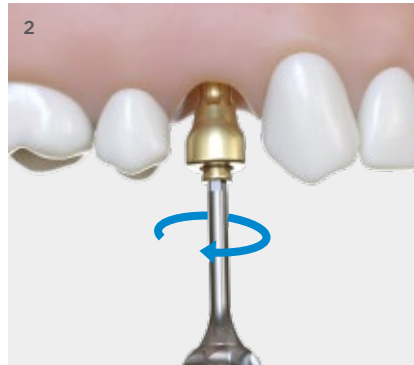

- Remove the healing component and check implant stability.

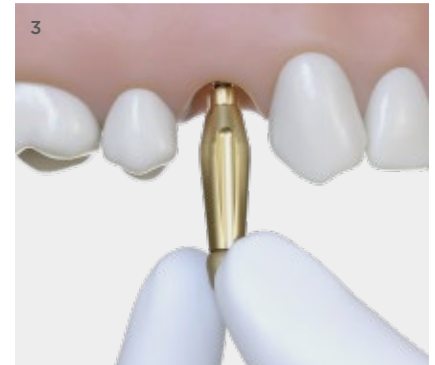

- Select a transfer of suitable length.

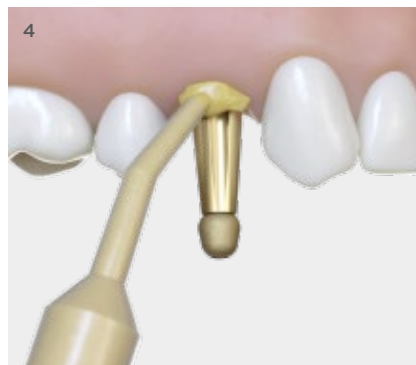

- Apply impression material around the transfer, followed by filling of the tray.
- Take the impression.



- Once the impression material has set, remove the impression and unscrew the transfer.
- Check the impression and ensure there is sufficient impression material for correct and stable retention of the transfer.

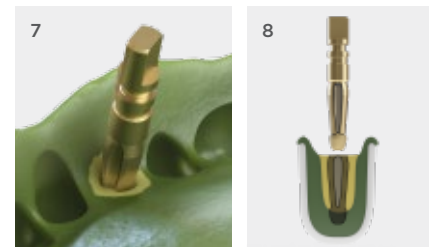

- Connect an analog to the transfer before it is carefully re-inserted into the impression.
- To secure the correct position and avoid mistakes, it is recommended to place the implant transfer, connected to the implant analog, back into the impression at the clinic.
- If there are several different connections or transfer lengths, make sure each one is identified and communicated to the lab.
- Aim the concave part on the implant transfer towards the convexity created in the impression and press down.
- When seated in the impression, slowly rotate the transfer to verify the correct position.

Due to updated design of the transfer, there will be two versions available. Make sure each one is identified and communicated to the lab.

Implant Analog EV

Implant analogs and lab abutment screws are necessary for efficient and safe laboratory fabrication of implant-level restorations.



Implant Analog EV

- Titanium
- Color coded



Lab Abutment Screw EV

- Titanium
- Primarily used at the laboratory by the dental technician
- Fits only into the implant analog
- Guide tip supports efficient handling
- Color coded

Laboratory procedure



- 1
- Select the appropriate analog corresponding to the impression component. Use the color coding together with information from the clinician.

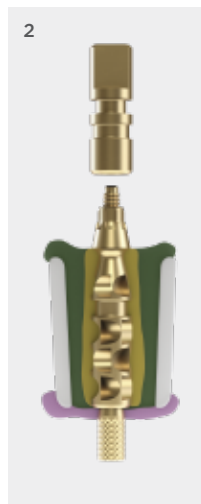

- 2
- Place the analog carefully in the correct position towards the pick-up.
 - Secure the analog with the pick-up pin, using manual tightening.
 - Prepare the impression with a soft-tissue mask around the implant analog.
 - Pour high quality stone into the impression to fabricate the master model.

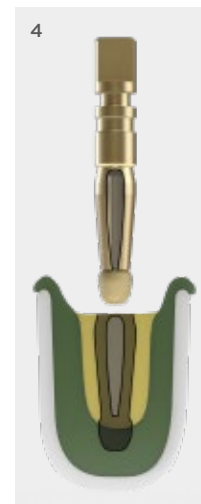
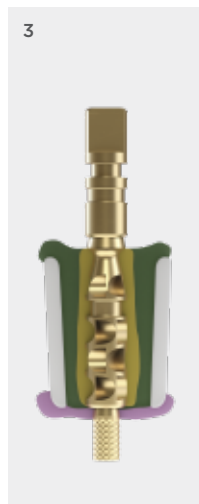









- 4
- Carefully re-insert the transfer connected to the analog into the impression.
 - Prepare the impression with a soft-tissue mask around the implant analog.
 - Pour high quality stone into the impression to fabricate the master model.



5. Cement-retained restorations



Abutment overview

Temporary abutments		Page	Indexing option	Clinical application	Features and benefits
TempAbutment EV Titanium		17 24		<ul style="list-style-type: none"> • Single, partial and fully edentulous situations • All positions in the mouth 	<ul style="list-style-type: none"> • Designed for individual build-up technique • Designed for long-term temporary restorations
Final abutments			Indexing option	Clinical application	Features and benefits
TiDesign EV Titanium		19 38		<ul style="list-style-type: none"> • Single, partial and fully edentulous situations • All positions in the mouth 	<ul style="list-style-type: none"> • Round – designed for the majority of restorative situations • Triangular – primarily for incisors and canines with triangular shape • Angled – for offset situations compensating for implants with a restorative unfavorable angulation • Color coded
TitaniumBase EV Titanium		20 34		<ul style="list-style-type: none"> • Single and partially edentulous situations • All positions in the mouth 	<ul style="list-style-type: none"> • High mechanical integrity • Strong and stable base • Provided with two flattened sides forming an anti-rotational feature
CastDesign EV Base: Gold-alloy Cylinder: POM burn-out plastic		22 33 39		<ul style="list-style-type: none"> • Single, partial and fully edentulous situations • All positions in the mouth 	<ul style="list-style-type: none"> • Designed for modification in the laboratory • Color coded

Temporary restoration procedures

TempAbutment EV

Functions as a customizable base for temporary implant-level restorations and allows for further sculpturing of the soft tissue.

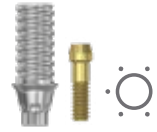

TempAbutment EV

- Titanium
- Designed for build-up technique
- Designed for long-term temporary restorations
- Color-coded abutment screw

Laboratory procedure - temporary crown



- 1
- Select a suitable abutment and do the necessary modifications.
 - Use the lab abutment screw when fabricating the temporary restoration.
 - Always mount the abutment to an analog and hold it with an instrument for safe and simplified modification.



- 2
- Select a plastic crown shell or denture tooth.
 - Modify the crown to fit onto the abutment and adjust the margin shape.



- 3
- Finalize and polish the restoration and perform a final try-in on the model.

Clinical procedure - temporary crown

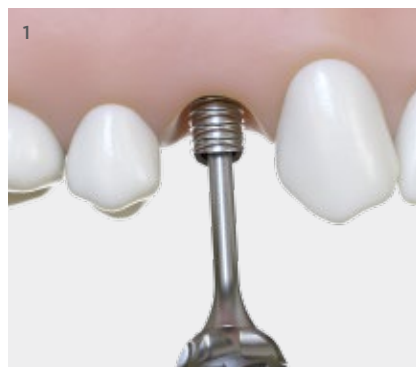

- 1
- Manually seat the abutment in the correct position before securing the abutment screw using the hex driver.
 - Tighten to the recommended torque, 15 Ncm, using a driver handle together with a machine hex driver and the torque wrench.

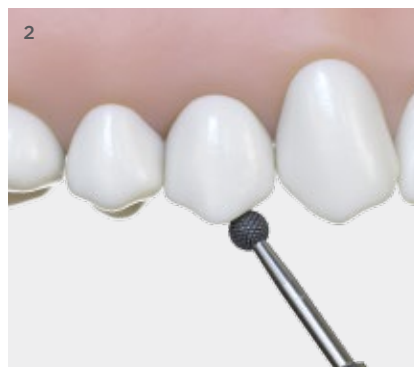

- 2
- Check the contact with adjacent teeth and the occlusion.
 - Make corrections if needed.

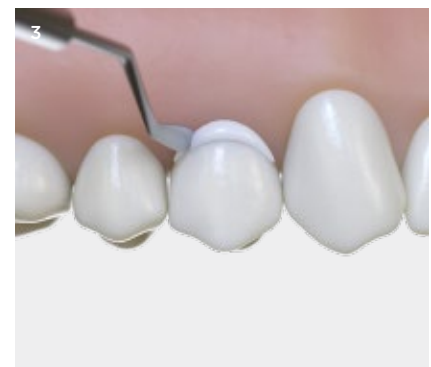

- 3
- Cover the screw head before the screw channel is filled with a suitable material.
 - Cement the crown onto the abutment and carefully remove all excess cement.
 - Cementation technique should be adapted to the restoration of choice and according to the instructions from the manufacturer.

The lab abutment screw is developed exclusively for use with the implant analog. Clinical abutment screws should not be used in the laboratory.



For chair side modification by the clinician and to avoid intra-oral grinding, the lab abutment screw is recommended to be used together with the appropriate implant analog.

Laboratory procedure – temporary bridge



- Select suitable abutments and do the necessary modifications.
- Use the lab abutment screw when fabricating the temporary restoration.
- Always mount the abutment to an analog and hold it with an instrument for safe and simplified modification.

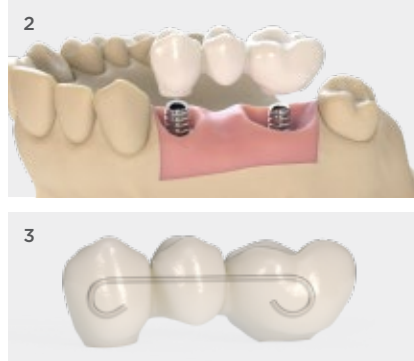

- Build up the bridge, including reinforcement, with composite veneers or prefabricated teeth and acrylic.



- Finalize and polish the restoration and perform a final try-in on the model.

Clinical procedure – temporary bridge



- Manually seat the abutments in the correct position before securing the abutment screws using the hex driver.
- Tighten to the recommended torque, 15 Ncm, using a driver handle together with a machine hex driver and the torque wrench.

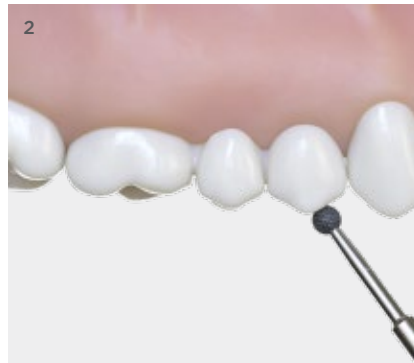

- Check the contact with adjacent teeth and the occlusion.
- Make corrections if needed.

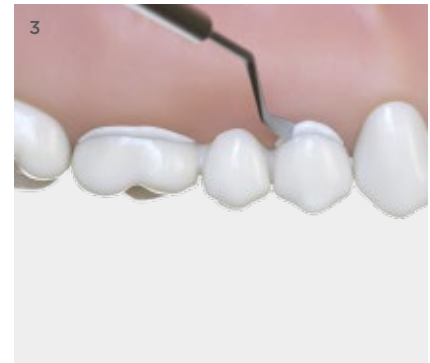

- Cover the screw heads before the screw channels are filled with a suitable material.
- Cement the bridge onto the abutments and carefully remove all excess cement.
- Cementation technique should be adapted to the restoration of choice and according to the instructions from the manufacturer.

Final restoration procedures

TiDesign EV

TiDesign is a two-piece, anatomically pre-designed abutment.

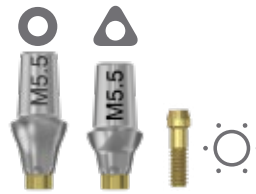

TiDesign EV

- Titanium
- Round - designed for the majority of tooth shapes
- Triangular - primarily for incisors and canines with distinct triangular shape
- Angled - for offset situations both in the anterior and posterior regions, compensating for implants with a restorative unfavorable angulation
- Color-coded abutment and abutment screw

Laboratory procedure



The lab abutment screw is developed exclusively for use with the implant analog. Clinical abutment screws should not be used in the laboratory.



- Select a suitable abutment.
- Always mount the abutment to an analog and hold it with an instrument for safe and simplified modification (see detailed handling procedure for abutments in section "Modification guidelines for TiDesign" page 38).

- Fabricate a crown

Clinical procedure

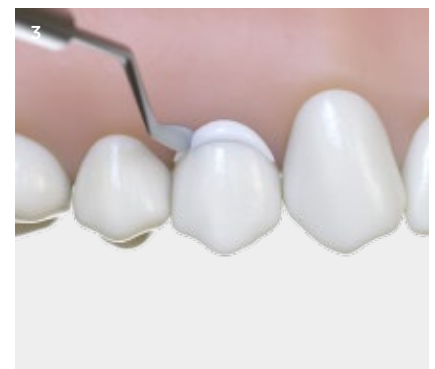
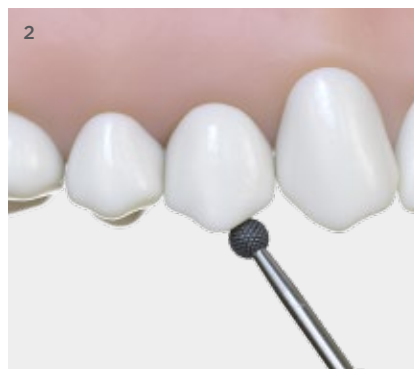
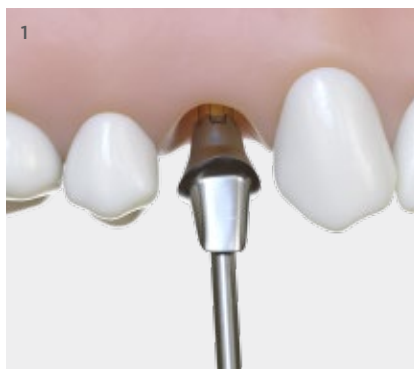

- Manually seat the abutment in the correct position before securing the abutment screw using the hex driver.
- Final tightening to the recommended torque, 25 Ncm, using a driver handle together with a machine hex driver and the torque wrench.

- Check the contact with adjacent teeth and the occlusion.
- Make corrections if needed.

- Cover the screw head before the screw channel is filled with a suitable material.
- Cement the crown onto the abutment and carefully remove all excess cement.
- Cementation technique should be adapted to the restoration of choice and according to the instructions from the manufacturer.

TitaniumBase EV

TitaniumBase combines the strength of a prefabricated titanium abutment with the individually designed ceramic core.

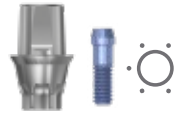

TitaniumBase EV

- Titanium
- TitaniumBase is provided with two flattened sides forming an anti-rotational feature
- Color-coded abutment screw

Clinical procedure



- Take a digital impression (intraoral scanning) or a conventional impression and send the case to a partnering laboratory.

Laboratory procedure

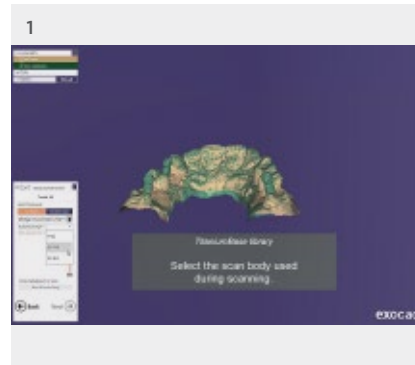

- Enter the help page for Dentsply Sirona Implants libraries at <https://www.orderdigitalsolutions.com/>
- Download the TitaniumBase libraries and learn more about how to use them
- The libraries are used when designing restorations for TitaniumBase. The libraries can be used for 3Shape and Exocad design software.
- The laboratory either uses the scans from the clinician or scans the model made from the conventional impression. It is important to use the correct scan body and follow the scanning instructions.
- Follow the user guide instructions for the downloaded library to be able to detect the implant position and design the restoration.
- Design and fabricate a ceramic core.



- Mount the TitaniumBase using a lab abutment screw into an implant analog.
- Seal the screw access channel.
- Before cementation, prepare the surfaces.
- Make sure not to modify, blast or touch the conical part of the base.
- Cement the ceramic top onto the base. Cementing technique should be adapted to the restoration and according to the instructions from the manufacturer.
- Remove all excess cement.

Laboratory procedure



- Fabricate the crown and transfer key.

Clinical procedure



- To ensure correct position, use the transfer key before final tightening of the abutment screw.
- Install the abutment, use the restorative driver handle together with the hex driver and the torque wrench to tighten to the recommended torque, 25 Ncm.

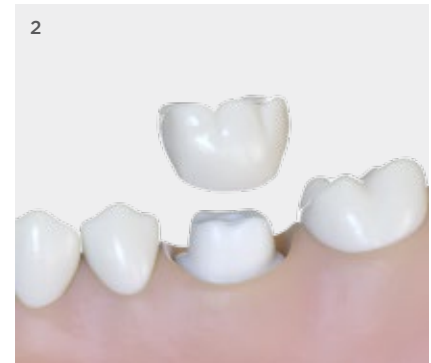

- Cover the screw head before the screw channel is filled with a suitable material.
- Check contact with adjacent teeth and the occlusion.
- Make corrections if needed.
- Cement the final restoration on the abutment. Cementation technique should be adapted to the restoration and according to the instructions from the manufacturer.
- Carefully remove all excess cement.

CastDesign EV

CastDesign is a non-oxidizing high-precious abutment modified at the laboratory. CastDesign is for fabrication of a customized abutment for cement-retained restorations, using regular wax-up and cast-to techniques.



CastDesign EV

- Gold-platinum alloy with POM plastic
- Color-coded plastic sleeve and abutment screw

Laboratory procedure



- Take an implant-level impression and fabricate the master model.

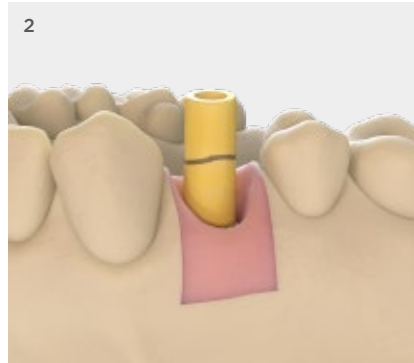

- Mark the appropriate height of the plastic sleeve, remove the abutment from the master model and adjust the plastic sleeve according to the marking.

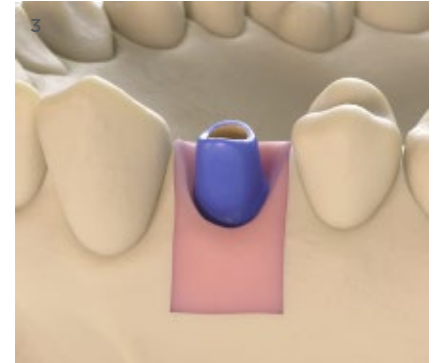

- Wax up, invest and cast the abutment (see Modification guideline page 39).
- Fabricate and finalize the crown.

Clinical procedure

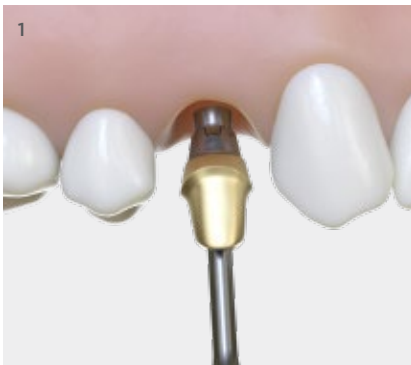

- Manually seat the abutment in the correct position before securing the abutment screw using the hex driver.
- Final tightening to the recommended torque, 25 Ncm, using the restorative driver handle together with a machine hex driver and the torque wrench.

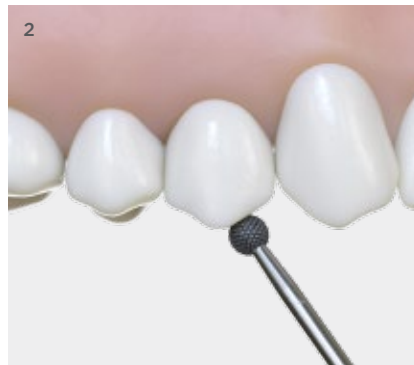

- Check the contact with adjacent teeth and the occlusion.
- Make corrections if needed.

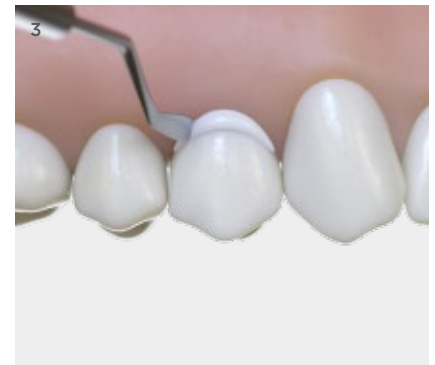







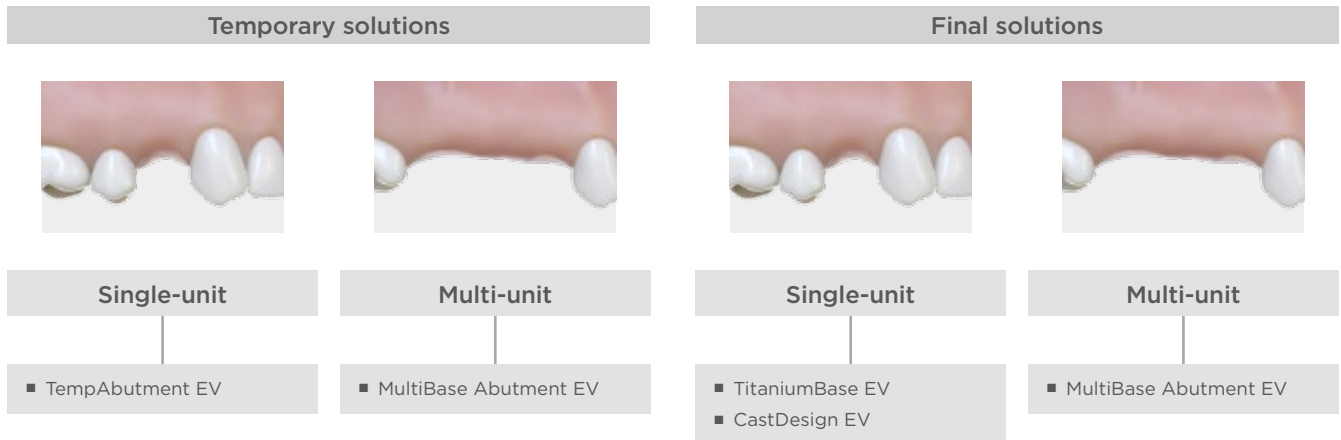



- Cover the screw head before the screw channel is filled with a suitable material.
- Cement the restoration onto the abutment and carefully remove all excess cement.
- Cementation technique should be adapted to the restoration of choice and according to the instructions from the manufacturer.

In cases where high bite forces are expected it is recommended to select a titanium abutment if possible. CastDesign should primarily be regarded as an abutment used when a pre-fabricated titanium option is not available.

6. Screw-retained restorations



Abutment overview

Temporary abutments		Page	Indexing option	Clinical Application	Features and benefits
TempAbutment EV Titanium		17 24		<ul style="list-style-type: none"> Screw-retained restorations, limited to single-tooth only All positions in the mouth 	<ul style="list-style-type: none"> Designed for individual build-up technique Designed for long-term temporary restorations
Final abutments			Indexing option	Clinical Application	Features and benefits
MultiBase Abutment EV, straight Titanium with a PEEK plastic holder		25		<ul style="list-style-type: none"> Screw-retained multiple unit restorations only All positions in the mouth 	<ul style="list-style-type: none"> Top cone enables bridge insertion on non-parallel abutments up to angulations of 42° Same prosthetic interface and components for all abutments Delivered with a plastic holder pre-mounted to the abutment for a simplified installation
MultiBase Abutment EV, angled Titanium with a PEEK plastic holder		25	 		
TitaniumBase EV Titanium		20 34		<ul style="list-style-type: none"> Screw-retained restorations, limited to single-tooth only All positions in the mouth 	<ul style="list-style-type: none"> Designed for cement- or screw-retained restorations Provided with two flattened sides for anti-rotation
CastDesign EV Base: Gold-Platinum alloy Cylinder: POM Burn-out plastic		22 33 39		<ul style="list-style-type: none"> Screw-retained restorations, limited to single-tooth only All positions in the mouth 	<ul style="list-style-type: none"> Designed for modification in the laboratory Color coded

Temporary restoration procedures

TempAbutment EV

Composite/acrylic crown built up and cured directly onto the modified temporary abutment or prefabricated plastic crown shell/denture tooth, integrated with the modified temporary abutment using acrylic.



TempAbutment EV

- Titanium
- Designed for build-up technique
- Designed for long-term temporary restorations
- Color-coded abutment screw

Laboratory procedure - temporary crown



- 1
- Select a suitable abutment and do the necessary modifications.
 - Use the lab abutment screw when fabricating the temporary restoration.
 - Always mount the abutment to an analog and hold it with an instrument for safe and simplified modification.



- 2
- Build up the crown structure on the abutment with composite or acrylic. Keep the screw access channel open.
 - Alternatively select a plastic crown shell or denture tooth and modify it to fit the abutment.
 - Finalize the crown on the abutment with acrylic. Keep the screw access channel open.



- 3
- Perform a final try-in on the model.
 - Adjust and polish the restoration.

Clinical procedure - temporary crown



- 1
- Manually seat the temporary restoration before securing the abutment screw using the hex driver.

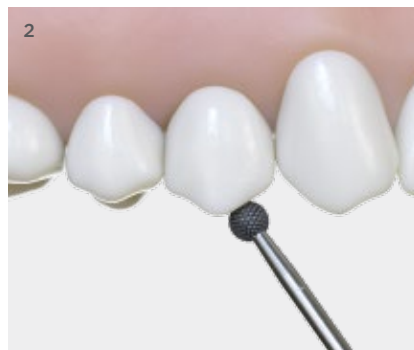

- 2
- Check the contact with adjacent teeth and the occlusion.
 - Make corrections if needed.

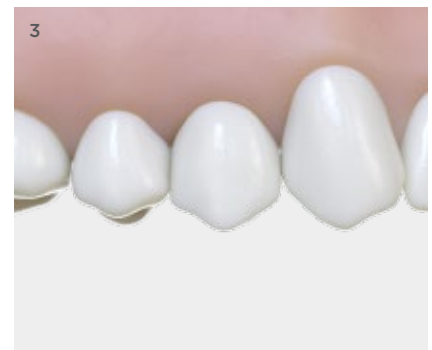

- 3
- Final tightening to the recommended torque, 15 Ncm, using the restorative driver handle together with the machine hex driver and the torque wrench.
 - Cover the screw head before the screw channel is filled with a suitable material.

The lab abutment screw is developed exclusively for use with the implant analog. Clinical abutment screws should not be used in the laboratory.



For chair side modification by the clinician and to avoid intra-oral grinding, the lab abutment screw is recommended to be used together with the appropriate implant analog.

Final restorations procedures

MultiBase Abutment EV

MultiBase Abutment, straight and angled

- Top cone enables bridge insertion on non-parallel abutments up to 42°
- Same prosthetic platform and components for all abutments



MultiBase Abutment EV, straight

- Titanium with a PEEK plastic holder
- One-piece abutment
- Non-indexed abutments can be seated in any rotational position
- PEEK holder has eight identification grooves



MultiBase Abutment EV, 17°/30°

- Titanium with a PEEK plastic holder
- Consists of three parts; abutment body, delivered with a pre-assembled abutment screw and a separate head part
- Indexed abutments can be seated in six different positions
- Non-indexed abutments can be seated in any rotational position
- PEEK holder on 17° abutment has four identification grooves
- PEEK holder on 30° abutment has six identification grooves

Clinical procedure - straight abutment connection

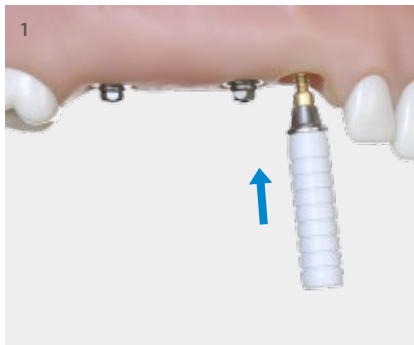

- Pick up the selected abutment in the pre-mounted plastic holder

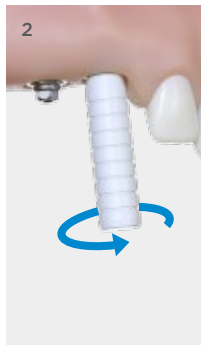

- Manually seat and secure the abutment using the holder.
- Snap off the holder.

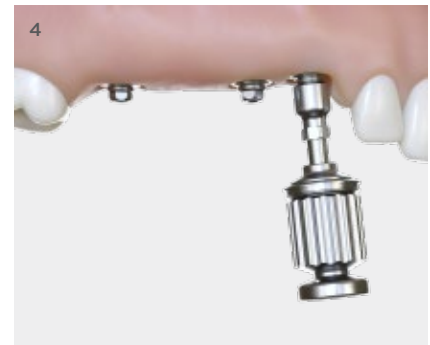
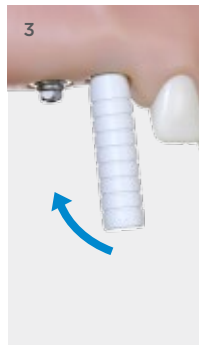

- Perform initial tightening with the restorative driver handle together with the MultiBase driver.



- Use the restorative driver handle together with the MultiBase driver and the torque wrench to tighten to the recommended torque, 25 Ncm.

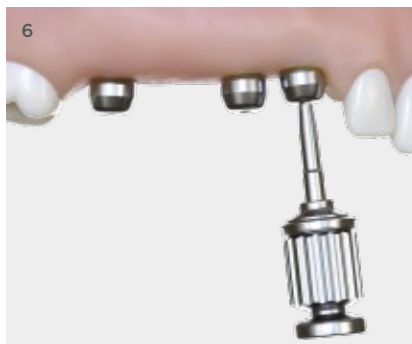

- Manually seat and secure the heal caps to the abutments with the hex driver, using light finger force, 5-10 Ncm.

The MultiBase driver is used for final tightening and removal of the MultiBase abutment.



MultiBase Abutment 30°



Clinical procedure - 30° abutment connection

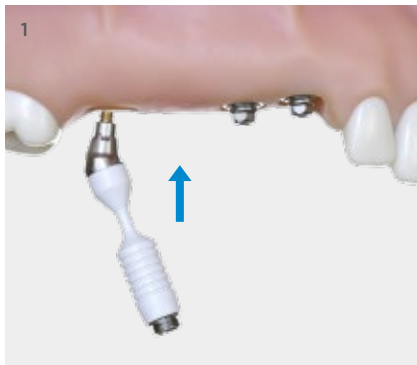

- Select the appropriate abutment angle and height.
- Connect the abutment body to the implant and rotate the abutment to the desired position.

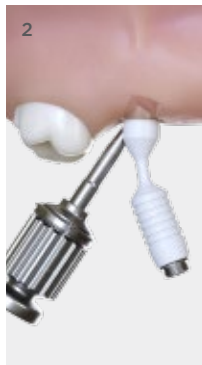

- The flexible holder can be bent to facilitate access to the abutment screw.
- Perform initial tightening of the abutment screw with a manual hex driver.
- Unscrew the holder from the abutment body.

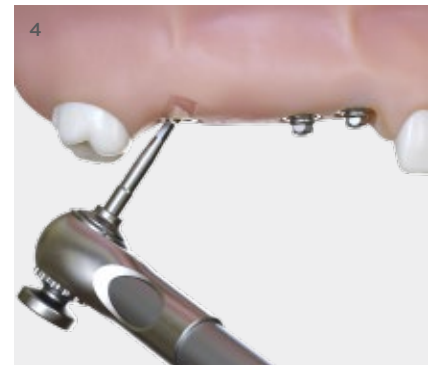
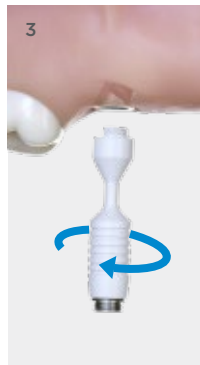

- Use the restorative driver handle together with the hex driver and the torque wrench to tighten the abutment screw to the recommended torque, 25 Ncm.

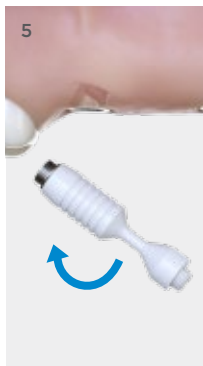

- Flip the holder 180 degrees to the side with the abutment head.
- Attach the abutment head to the abutment body with the holder.

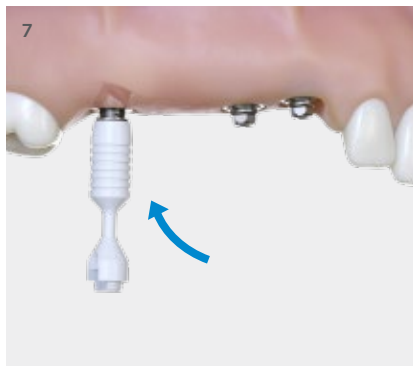
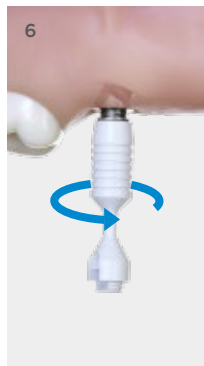

- Snap off the holder.

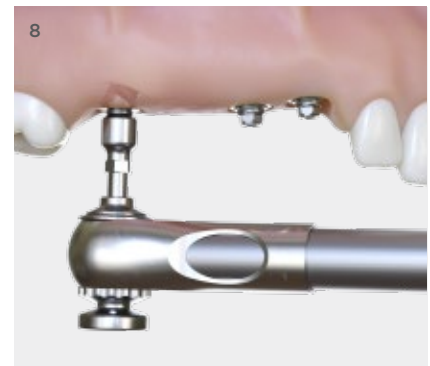

- Use the restorative driver handle together with the MultiBase driver and the torque wrench to tighten the abutment head to the recommended torque, 25 Ncm.

This procedure also applies for MultiBase Abutment EV 17°.

MultiBase Pick-Up

Abutment level pick-ups are used for open tray impression procedures.



MultiBase Pick-Up

- Stainless Steel
- Two-piece pick-up, with a pronounced groove for splinting possibility

Clinical procedure – open tray



- Prepare and use a standard or customized open impression tray.



- Connect the pick-ups using the hex driver.
- Secure the pick-ups using the manual tightening torque, 5-10 Ncm.

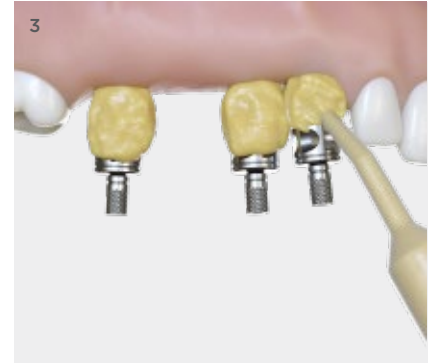

- Apply an elastomeric impression material around the pick-ups.

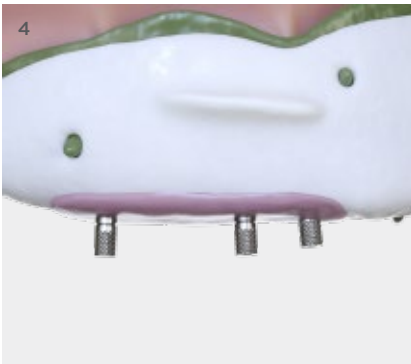

- Place the tray, filled with the impression material, and take the impression.
- Once the impression material has set, unscrew the pins and remove the impression.
- Check the impression for correct and stable retention of the pick-ups.

Close tray options also available with MultiBase transfer.



MultiBase Analog

MultiBase analogs are necessary for efficient and safe laboratory fabrication of abutment-level restorations.



MultiBase Analog

- Stainless steel
- Single-use

Laboratory procedure

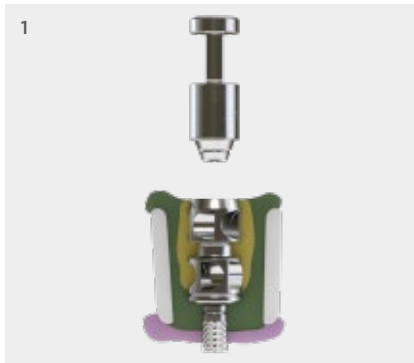

- Connect the analogs carefully to the pick-ups and tighten.
- Secure the analogs using a manual tightening torque, 5-10 Ncm.



- Prepare the impression for duplication with a removable soft-tissue mask by applying silicone around the analogs.
- Pour high quality stone and fabricate the master model.

MultiBase Temporary Cylinder

MultiBase temporary cylinders provide a base for temporary bridges.

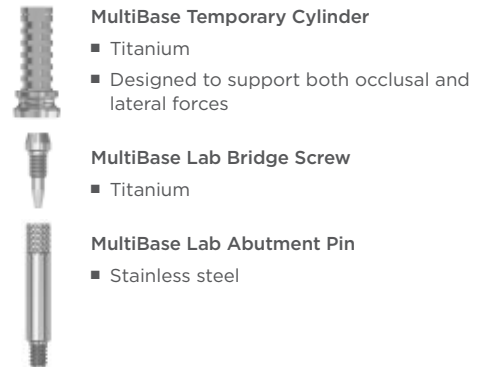

Laboratory procedure

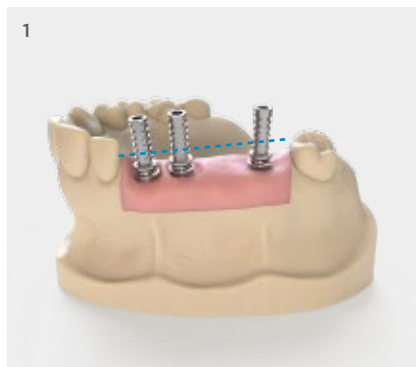

- 1
 - Attach the temporary cylinders to the analogs with lab bridge screws or lab abutment pins.
 - Mark the appropriate height of the cylinders, remove them from the master model and adjust according to the markings.



- 2
 - Use lab bridge screws when fabricating the temporary restoration. The screws should be replaced with MultiBase bridge screws when placing the temporary bridge in the mouth.



- 3
 - Fabricate a metal or fiber reinforced bridge framework.
 - For better esthetics, opaque masking is recommended above the margin on the surface of the titanium cylinder.
 - Build up the bridge with prefabricated teeth and acrylic, or composite veneers and avoid coverage of the cylinder margins.



- 4
 - Use lab abutment pins to keep screw access holes open during veneering.
 - Finalize the temporary bridge by curing and polishing.

MultiBase Temporary Cylinder

MultiBase temporary cylinders provide a base for temporary bridges.



MultiBase Bridge Screw

- Titanium
- Anodized (light blue)

Clinical procedure



- Install the restoration with the bridge screws using the hex driver.

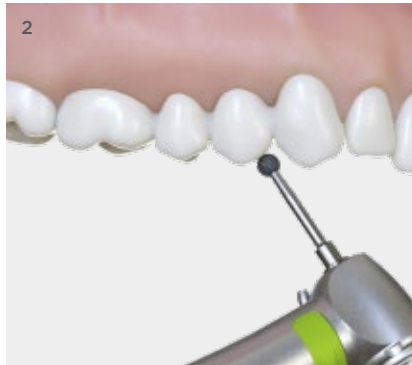

- Check contact with the adjacent teeth and the occlusion.
- Make corrections if needed.

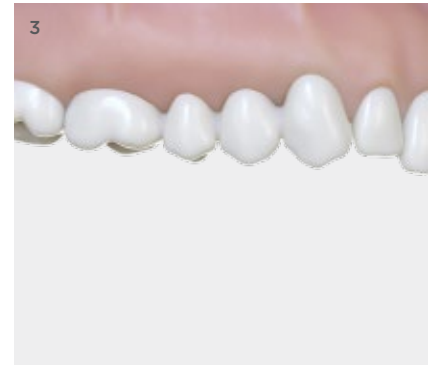

- Use the hex driver together with the restorative driver handle and the torque wrench to tighten to the recommended torque, 15 Ncm.
- Cover the screw head before the screw channel is filled with a suitable material.

MultiBase Semi-Burnout Cylinder

Procedures for conventional wax-up technique with a burnout and casting process.



MultiBase Semi-Burnout Cylinder

- Gold-platinum alloy and POM burnout plastic
- The alloy used for casting must be compatible with the gold-platinum alloy in the semi-burnout cylinder.

Laboratory procedure

1



- Place the semi-burnout cylinders on the analogs with lab bridge screws or lab abutment pins.
- Mark the appropriate height of the plastic sleeves, remove the cylinders from the master model and adjust according to the markings.
- When modifying the plastic sleeve, take care not to damage the screw seating portion of the cylinder.

2



- Design the framework according to general restorative principles. Consider available space, loading conditions, implant position and angulation.
- Integrate the cylinders in a wax-up framework designed for PFM.
- Use lab abutment pins to keep the screw access holes open during wax-up.
- The plastic part of the semi-burnout cylinders will be combusted and only the gold base will be incorporated in the cast metal framework.

3



- Divest the framework. Make sure the screw access holes are free from investment material, and the screw seat surfaces are unmodified.
- Make sure not to damage the connection part of the cylinder during blasting.
- Try-in on the model and confirm passive fit and appropriate design.

4



- Prepare and veneer the metal framework.

5

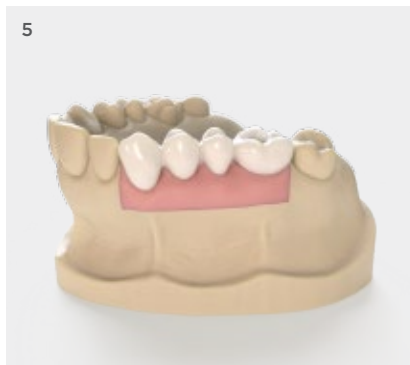

- Use lab abutment pins to preserve access to the screw channels during veneering.

Technical data

Melting range:

1400-1490° C/2552-2660° F

Coefficient of thermal linear expansion for alloy:

25-500° C/77-932° F 12.3 (10-6/° C)

25-600° C/77-1112° F 12.7 (10-6/° C)

Base: Non oxidizing gold alloy Au 60%, Pd 20%, Pt 19%, Ir 1%

Cylinder: POM burnout plastic

Burn-out option available with MultiBase Burnout Cylinder. The burn-out cylinder is totally combusted and replaced with the preferred alloy during casting.





MultiBase Bridge Screw

- Titanium
- Anodized (light blue)

Clinical procedure



- Try-in the restoration and make sure it has a passive fit.

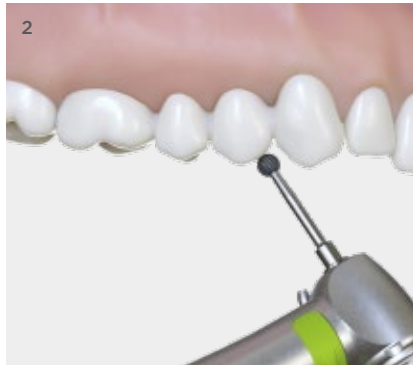

- Check contact with the adjacent teeth and the occlusion.
- Make corrections if needed.



- Install the restoration with the bridge screws to the recommended torque value, 15 Ncm, using a restorative driver handle together with a hex driver and the torque wrench.

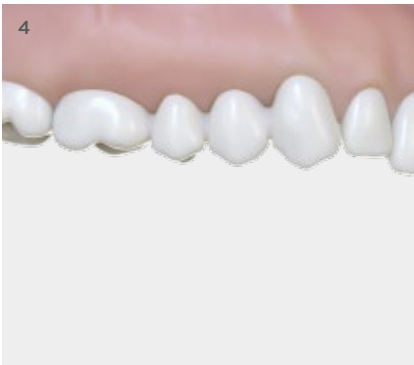

- Cover the screw heads before the screw channels are filled with a suitable material.

CastDesign EV

The CastDesign is a non-oxidizing high-precious abutment modified at the laboratory. CastDesign is used for fabrication of a customized abutment for single screw-retained restorations, using regular wax-up and casting procedures.

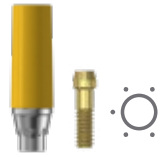

CastDesign EV

- Gold-platinum alloy with POM plastic
- Color-coded plastic sleeve and abutment screw

Laboratory procedure



- Take an implant-level impression and fabricate the master model.

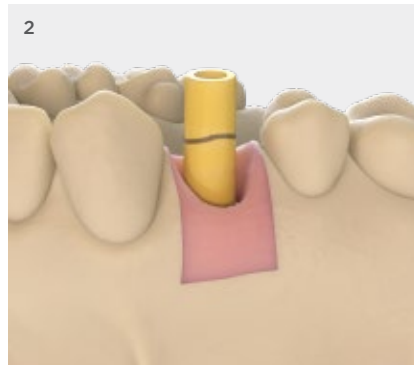

- Mark the appropriate height of the plastic sleeve, remove the abutment from the master model and adjust the plastic sleeve according to the marking.



- Wax up the crown core corresponding to the planned prosthetic restoration (for detailed information, please refer to the modification guideline, page 39).
- Cast and finalize the crown core.
- Prepare and veneer the metal framework.
- Finalize the crown.

Clinical procedure

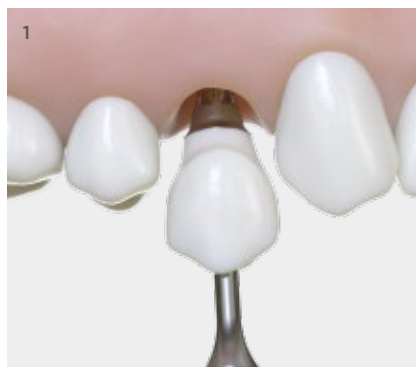

- Manually seat the crown before securing the abutment screw using the hex driver.

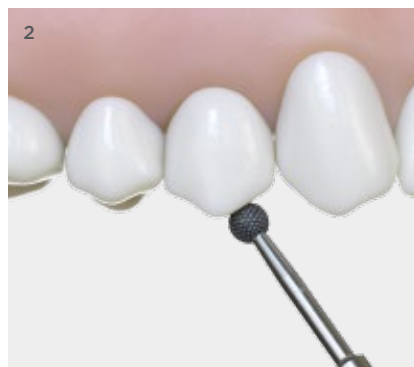

- Check the contact with adjacent teeth and the occlusion.
- Make corrections if needed.

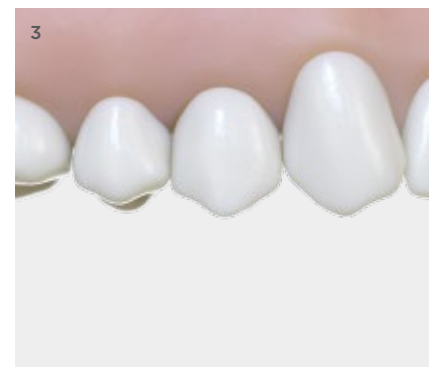

- Use the restorative driver handle together with the hex driver and the torque wrench to tighten to the recommended torque, 25 Ncm.
- Cover the screw head before the screw channel is filled with a suitable material.

For screw-retained restoration, CastDesign EV shall be used for single-tooth applications only. Use of this product outside the listed indications will compromise the function of the Conical Seal Design and void the warranty.

For chair side modification by the clinician and to avoid intra-oral grinding, the lab abutment screw is recommended to be used together with the appropriate implant analog.

TitaniumBase EV

TitaniumBase combines the strength of a prefabricated titanium abutment with the individually designed ceramic core.



TitaniumBase EV

- Titanium
- TitaniumBase is provided with two flattened sides forming an anti-rotational feature
- Color-coded abutment screw

Clinical procedure



- Take a digital impression (intraoral scanning) or a conventional impression and send the case to a partnering laboratory.

Laboratory procedure

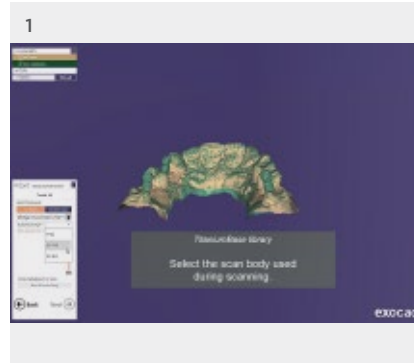

- Enter the help page for Dentsply Sirona Implants libraries at <https://www.orderdigitalsolutions.com/>
- Download the TitaniumBase libraries and learn more about how to use them
- The libraries are used when designing restorations for TitaniumBase. The libraries can be used for 3Shape and Exocad design software.
- The laboratory either uses the scans from the clinician or scans the model made from the conventional impression. It is important to use the correct scan body and follow the scanning instructions.
- Follow the user guide instructions for the downloaded library to be able to detect the implant position and design the restoration.
- Design and fabricate a ceramic crown.



- Mount the TitaniumBase using a lab abutment screw into an implant analog.
- Before cementation, prepare the surfaces.
- Make sure not to modify, blast or touch the conical part of the base.
- Cement the ceramic crown onto the base. Cementing technique should be adapted to the restoration and according to the instructions from the manufacturer.
- Remove all excess cement.

Clinical procedure



- Manually seat the crown before securing the abutment screw using the hex driver.



- Check the contact with adjacent teeth and the occlusion.
- Make corrections if needed.

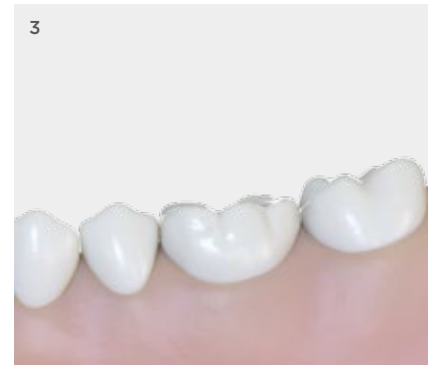

- Use the restorative driver handle together with the hex driver and the torque wrench to tighten to the recommended torque, 25 Ncm.
- Cover the screw head before the screw channel is filled with a suitable material.

7. Appendix

SmartFix concept

With the SmartFix treatment concept patients can benefit from an immediate implant-supported restoration, as a temporary prosthesis is screwed onto the implants on the day of surgery. Final solutions for the SmartFix treatment concept include both fixed prostheses and removable solutions e.g. Atlantis patient-specific suprastructures.

[For further information and step-by-step procedures refer to SmartFix concept manual.](#)



Acuris conometric concept

Acuris is a paradigm shift in prosthetic retention of single crowns that are fixed yet retrievable by the clinician. The friction-based retention offers a fixation mode providing the esthetics of a cement-retained crown, maintaining retrievability and excluding the risk of submucosal residual cement.

[For further information and step-by-step procedures refer to Acuris conometric concept manual.](#)



WeldOne concept

The WeldOne concept provides a stable framework with a passive fit for immediate restorations, as temporary or durable prostheses, at the same day as the surgery.

[For further information and step-by-step procedures refer to WeldOne concept manual.](#)

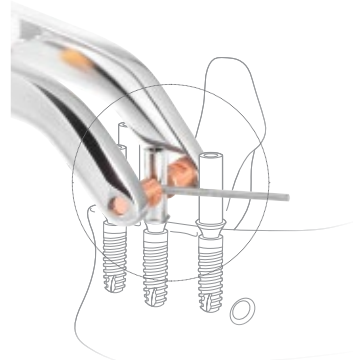

Cleaning and sterilization instructions

Products within DS Implants are designed to be cleaned and sterilized before clinical use with the exception of sterile products. The cleaning and sterilization instructions have been developed and validated by Dentsply Sirona in accordance with the applicable standards.

[For further information and step-by-step procedures refer to the Cleaning and sterilization instruction. For products with alternative legal manufacturer see respective product's IFU.](#)



LOCATOR R-Tx® concept

[For full product assortment and step-by step procedures refer to www.zestdent.com](http://www.zestdent.com) for more information.

Torque Wrench EV

The torque wrench together with a restorative driver handle is used to tighten abutment screws and/or bridge screws.

When used together with a surgical driver handle, the torque wrench can also be used for implant installation, adjustment and removal.

Applicable instruments

- Hex Driver
- Multibase Driver
- Torque Wrench EV Restorative Driver Handle
- Torque Wrench EV Restorative Driver Handle Low
- Torque Wrench EV Surgical Driver Handle
- Torque Wrench EV Restorative Driver Handle 4x4 Low



- Assemble the head of the wrench and the body by pushing the components together and turning them in opposite directions until there is an audible click.



- Attach the hex driver into the driver handle and then into the wrench until there is an audible click.



- Use a finger on the top of the driver handle to keep it steady and in place.
- Gently pull the arm of the torque wrench in the direction of the arrow until the desired torque is achieved.

The arm of the torque wrench must not go beyond the end of the scale, as this could result in inaccurate torque readings.

The arrow on the head of the wrench shows the direction in which the wrench is functioning.



Modification guideline

TiDesign EV

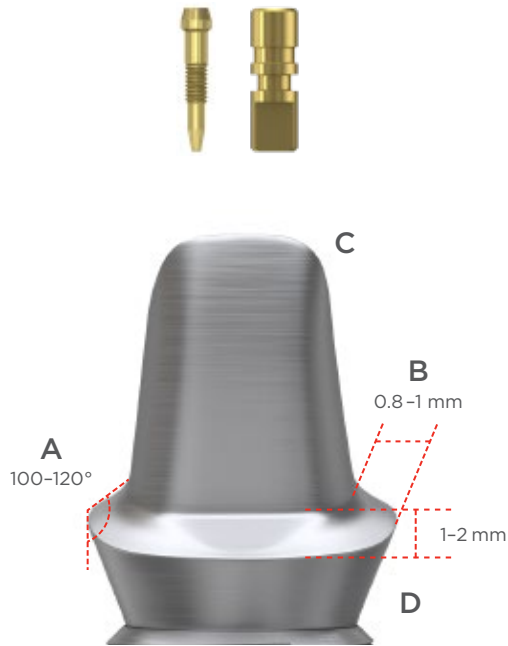

- Attach the abutment into an implant analog using a lab abutment screw and hold it with an instrument.
 - Design the preparation with a shoulder or a chamfer to adequately support the restoration. Use grinders specifically manufactured for titanium.
- A.** When preparing for the final restoration, the shoulder or chamfer preparation should approximately range from 100-120°.
- B.** Maintain a margin shelf range of 0.8-1 mm.
- C.** Avoid sharp edges and corners to ensure a good fit between the abutment and the restoration.
- D.** Create the prosthetic margin just below the soft-tissue level
- To ensure the strength of the abutment, maintain a minimum thickness of the remaining walls of at least 0.5 mm. Any inadvertent grinding below the final crown margin should be polished.
 - Make sure not to damage the connection part of the abutment during modification. A general recommendation is to stop reduction of the abutment 1 mm above the connection part and avoid radical changes in that area. Blasting, grinding, cutting and polishing must not be done on the conical part, indexing part or on the screw seat of the abutment.
 - The angled TiDesign (XS) for 3.0 implants must be carefully modified with a minimum of reduction, especially at the base of the abutment pillar (see the red marked area).

Modification guideline

CastDesign EV



- The abutment is modified in the laboratory.
- The abutment can be prepared to compensate for angulations as long as the sufficient retention is present and loading conditions are non-critical.
- Modify the plastic part of the abutment and shape it in wax before the cast-to procedure. Do not remove the plastic around the area of the metal cylinder.
- Check the wax-up for occlusal and approximal clearance, ensuring there will be adequate crown material in all directions. Make sure to minimize the extended design from the center axis.
- When designing an abutment, make sure the wax-up is thick enough to avoid a miscast. The margin is normally placed below the soft-tissue margin.
- Before investing the modified abutment, it is important to remove all excessive wax from the metal areas. The metal should also be cleaned with acetone to ensure safe investing, thus minimizing the risk of air bubbles or unwanted casting errors.
- Burnout and cast the abutment by using an alloy compatible with the metal thermal expansion coefficient of the abutment.
- Investing and burnout time should follow the recommendations from the manufacturer of the investment material. The burnout time should be extended when plastic parts are included in the invested object.
- In order not to violate the conical seal, make sure not to damage the conical connection and the screw seat of the abutment during removal and blasting.
- Make sure to keep the surface of the screw seat unmodified, not to violate screw joint properties. Blasting, grinding, cutting and polishing must not be done on the conical part, indexing part or on the screw seat of the abutment.

Considerations

- Extended pillar height in combination with a highly angled abutment must be carefully evaluated.
- Do not modify or extend gold and/or porcelain onto the conical part of the abutment.
- It is not possible to apply porcelain directly to the high-precious alloy of the CastDesign EV.

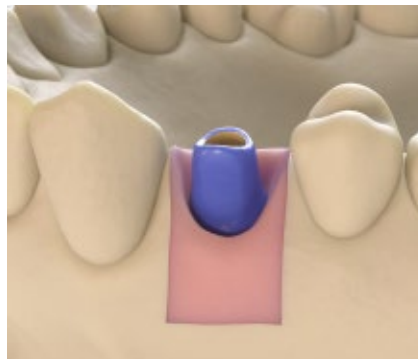
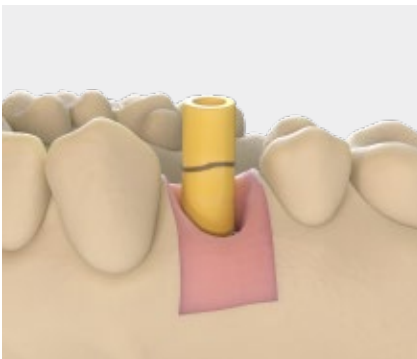

Technical data

Melting range: 1400–1490°C/2552–2660°F

Coefficient of thermal linear expansion for alloy:
25–500°C /77–932°F 12.3 (10–6/°C)25–600°C /
77–1112°F 12.7 (10–6/°C)

Base: Non oxidizing gold alloy Au 60%, Pd 20%, Pt 19%, Ir 1%

Cylinder: POM burnout plastic

The abutment will absorb a lot of heat during burnout and casting. Make sure to compensate for this by increasing the preheating time.. Raise the temperature slowly to the final temperature.

The cast-on alloy must have a casting temperature that is below the solidus (1400°C/2552°F) of the abutment.

THE DENTAL
SOLUTIONS
COMPANY™

