

THE DENTAL
SOLUTIONS
COMPANY™

 Dentsply
Sirona

For the Dental Practice

Product Catalogue

Middle East and North Africa

Edition Two
[dentsplysirona.com](https://www.dentsplysirona.com)



Dear Doctor

It gives me great pleasure to present the second edition of the Middle East and North Africa (MENA) Dentsply Sirona product catalogue for the dental practice.

Following the Dentsply and Sirona merger in early 2016 and now working together under one brand globally, Dentsply Sirona MENA is dedicated to bringing you the best products, services, support, education and events that we have to offer. Our brand promise of offering better, safer, faster care in all dental disciplines for our dental professionals underpins our drive to improve patient experience and practice lifestyle, while providing you with the opportunity to influence and shape dentistry in MENA.

Our comprehensive end-to-end solutions are scientifically developed, manufactured to the highest quality specifications and delivered to you chairside. My team and I are focused on providing seamless integration to ensure that you will be able to consistently deliver a superior outcome to your patient.

Our regional head office in Business Bay, Dubai, offers extensive clinical, technical and practice excellence educational courses in our new facilities, including a 20-participant training centre, CEREC suite and full showroom - all in the aim to deliver value to you. I encourage you to contact our sales representatives and/or marketing team to organize a product demo or participate in range of live weekly webinars and digital clinical education. We look forward to welcoming you soon.

I hope you enjoy discovering our complete Dentsply Sirona offerings for the dental practice and thank you for your continued support towards Dentsply Sirona.

AMRO ADEL
General Manager,
Dentsply Sirona MENA

Table of contents



12	Treatment Centres	
34	Imaging	
74	Implants	
82	Instruments/ Table Top	
120	Preventive	
4	About Dentsply Sirona	
6	Middle East North Africa Introduction	
8	Clinical Education	
10	Contact and Ordering Information	
142	Endodontics	
196	Restoratives	
238	CAD/CAM Chairside	
290	Index	



Together we can achieve more

More than a century of storied history and innovative leadership

Over the years, both of our DENTSPLY and Sirona legacies have set a global standard for dental manufacturing, technology development, digital treatment and clinical education. Throughout our history, we have been at the forefront of innovation to improve and advance dentistry.

Dentsply Sirona traces its roots to humble beginnings - DENTSPLY International was founded as Dentists' Supply Company in 1899 in New York City and the company that became Sirona Dental Systems was founded in 1877 in Erlangen, Germany. Through our transformative merger in 2016, Dentsply Sirona has grown to become the world's largest manufacturer of professional dental products, technologies and solutions. Our trusted brands have empowered dental professionals, in both practices and laboratories, to provide better, safer, and faster care in all dental disciplines for over 100 years. Now, working together under one brand globally, we are dedicated to continuing this journey for many years to come. Together we have unmatched scale and resources and are committed to using them to continue driving innovation and helping dental professionals achieve more than ever before.



FOR BETTER, SAFER, FASTER DENTAL CARE The Dental Solutions Company™

As The Dental Solutions Company™, Dentsply Sirona provides dental professionals a comprehensive end-to-end solutions offering. This offering includes some of the best-known and established brands in the industry. We develop, manufacture and market a complete line of dental and oral health products, including general dental supplies and devices, CAD/CAM restoration systems (CEREC and inLab), a full suite of dental restorative products, digital intra-oral, panoramic and 3D imaging systems, dental treatment centres, handpieces, hygiene systems, and dental specialty products in orthodontics, endodontics and implants. Additionally, our global consumable healthcare product team provides innovative urological and surgical solutions designed to improve quality of life for patients.

Everything from one company

Not only do we have one of the largest product and technology portfolios on the market, but coupled with our broad clinical education platform and service support teams, we are able to offer complete solutions for all dental needs directly from one company. We support you through each stage of your dental journey and are proud to be a preferred partner for dental practices, clinics, dental laboratories and authorised distributors worldwide.





CLOSER TO OUR CUSTOMERS IN MENA

New Operational Hub in Business Bay, Dubai

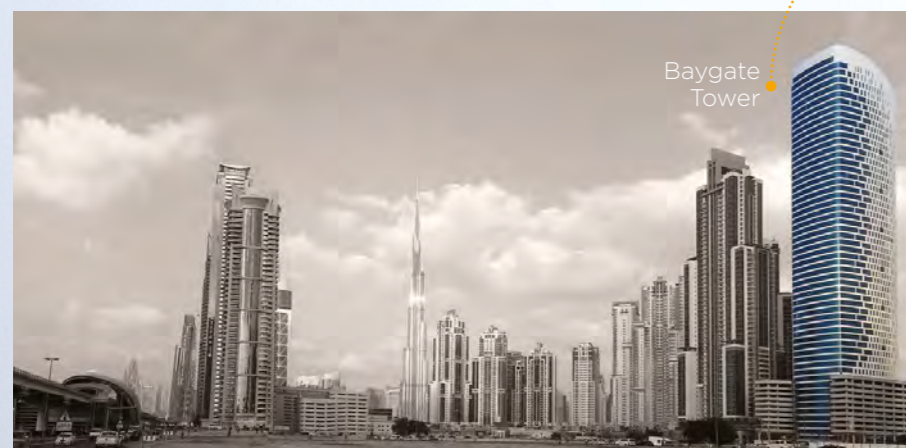

Training facilities

Our new office in Dubai has been equipped with a large open plan showroom to showcase our equipment offering, a CAD/CAM suite to offer potential customers hands-on experience and existing users ongoing training, and a training centre which can accommodate twenty participants at any one time for lectures and hands-on courses.

Dual branding

We sometimes adopt a dual branding strategy to enable us to offer you our best products and solutions at local market price levels. This means we launch the same product as Europe and the United States, but with a different brand name and packaging to enable us to sell the product at a more competitive price for our market. Examples of dual branding can be seen within our restorative portfolio, such as our new adhesive product launch Prime&Bond universal™.



Our people

Our trusted field based team includes CAD/CAM, equipment, implantology and clinical specialists, alongside our dedicated local sales representatives and service engineers all directly trained by the manufacturer. These in turn are supported by our customer service, marketing, finance, regulatory, and HR functions who are based in the Dubai office. With over 80 employees representing many different nationalities, Dentsply Sirona MENA promotes a multinational and multicultural environment.

The strength of the service we offer is evidenced by the size and skill of our team located throughout MENA and our commitment to ensuring that your needs and that of your patients are always at the forefront.



Our service

Dentsply Sirona's technical service and support teams are experts at installing, calibrating, maintaining, supporting and providing solutions for all your Dentsply Sirona technology. All our Dentsply Sirona service engineers are responsive, factory-trained and have a wealth of resources, enabling them to meet your service needs quickly and efficiently. The team have the ability to remotely connect and diagnose your Dentsply Sirona equipment, often avoiding the need for an onsite visit.

Our focus is on maximising your up-time through preventive maintenance, breakdown service and ensuring the reliable operation of your technology.





DEVELOPING OUR CUSTOMERS FOR THE FUTURE

Clinical Education

Recognised as a global leader in dental education, our Dentsply Sirona Academy provides worldwide access to valuable, evidence based education, delivered by world renowned Key Opinion Leaders. Our aim in providing this educational platform is simple, to help equip you with all the necessary skills to provide better, safer, faster care across every dental discipline.

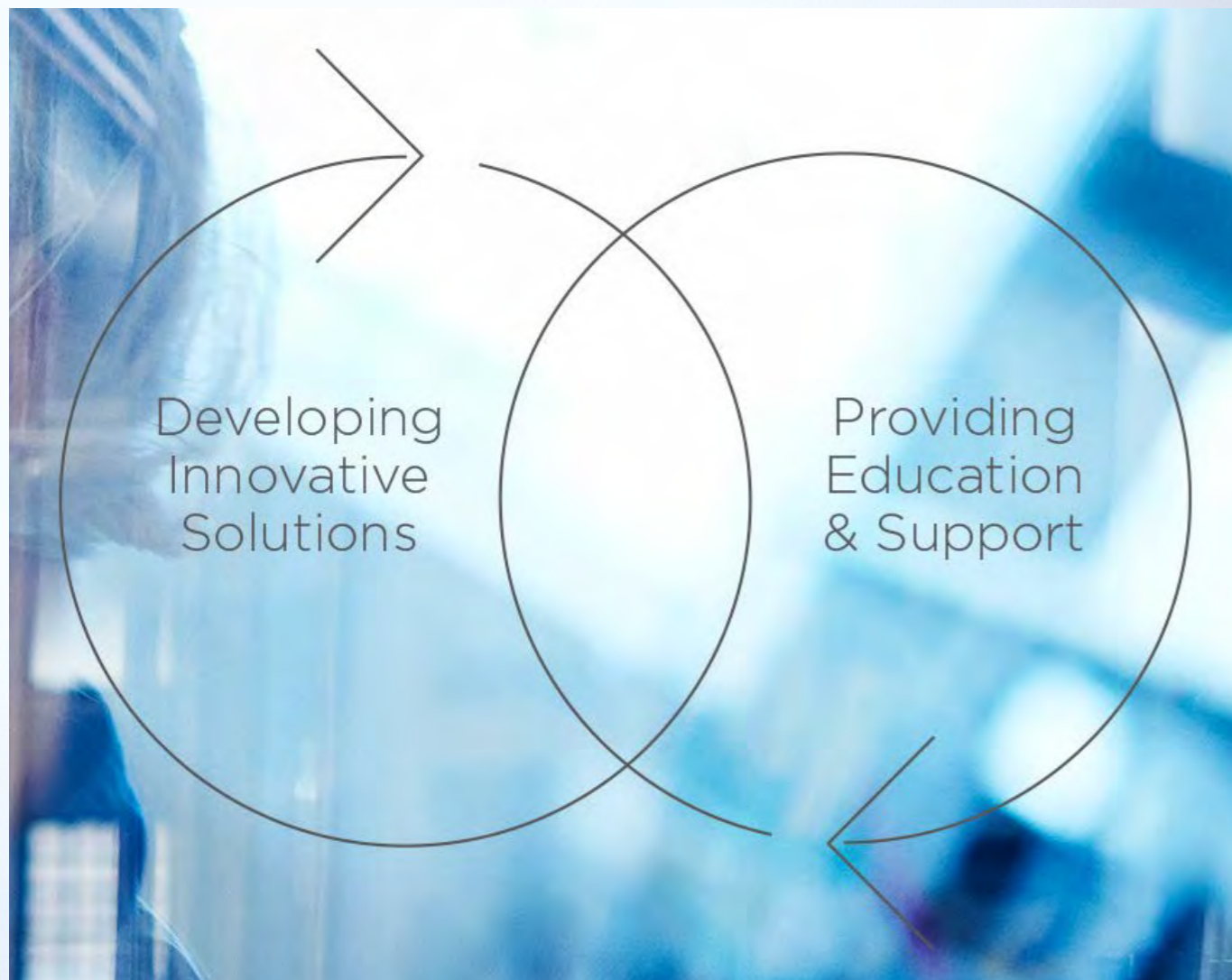

To discover our upcoming Clinical Education schedule for MENA, please go to:

dentsplysirona.com/education



Commitment

Dentsply Sirona is committed to training and education. In addition to world class facilities, we partner with leading clinical educators to offer practical, interesting courses that draw on global advances in research and development.

Focus

Education drives innovation, learning and partnership. Our specialists and customers can access best practice learning methods to further their education and implement practical solutions, which provide better patient outcomes.

Investment

We continue to invest in exceptional educational facilities. Our Dentsply Sirona Academy, CAD/CAM suite, and showroom in our Dubai office has been operational since 2017. We offer access to international and local practitioners.

Innovation

To maximise the benefits provided by innovation, education propels each procedure to achieve optimal patient outcomes. Our training and development is supported by over 600 scientists worldwide, who work to deliver innovation to you as it occurs.

Support

In addition to clinical support, we assist with practice development, improving growth and driving efficiency of dental practices at a local level. With an extensive CE support network both local and global, we are the preferred partners in education and training.

Partnership

Our commitment to the continued education of healthcare professionals, development of practice staff and provision of innovative and integrated solutions, provides you with a competitive advantage which empowers you to deliver superior dental care.



WE'RE HERE FOR YOU

Dentsply Sirona Contact Information

As our valued customer, we at Dentsply Sirona would like to introduce our dedicated team working together in partnership with you to provide complete dental solutions.

Our team provide a high level of expertise in all fields of dentistry. Our aim is to ensure efficient delivery of product knowledge, customer satisfaction and experience, empowering you to deliver solutions that meet the needs of your patients and your practice.

Local Distributors

They're here for you

At Dentsply Sirona, we value our long-standing relationships with our authorized distributor partners. Together, we provide tremendous value and excellent quality. To order any Dentsply Sirona products mentioned in this catalogue or for more information, please contact your local distributor.

Ordering Information

Your Dentsply Sirona Future

You can choose from nearly 5,000 products to order from this Dentsply Sirona MENA product catalogue for the dental practice. Product orders will be processed by your nominated dental distributor for delivery and invoicing at your usual distributor prices, or direct in the UAE for our Equipment ranges.

Find your local
Dentsply Sirona
Representative

Find your local
Dentsply Sirona
representative by
clicking this link:
Local Distributors
or scan the QR code:



Head Office

Bay Gate Tower, 21st Floor,
Al Sa'ada Street, Business Bay,
P.O. Box 13734
Dubai
United Arab Emirates
Tel: +971 4 523 0600
www.dentsplysirona.com

Marketing and Events

mea-marketing@dentsplysirona.com

Transforming the Modern Treatment Centre

Treatment centres are of the utmost importance to the efficiency of procedures and patient experience, in all dental disciplines. Our treatment centres, well-known for their modern and ergonomic designs and high quality materials, can be perfectly integrated into any practice network. They allow for the addition of numerous innovative functions to support integrated workflows in fields like endodontics and implantology, and the smooth surfaces ensure the highest possible hygiene standards.

Our Treatment Centre solutions support:



100

years of experience



30

innovative solutions
every year



\$125M

R & D investment
every year

Quality beyond reliability:

"When it comes to our Treatment Centres, quality means much more than reliability for us. We constantly strive to offer you a maximum of integrated functions, innovative solutions and iconic design for an incomparable experience for you and your patients."

Thomas Nack, Director Research & Development Treatment Centres



Contents



Treatment Centres

Teneo	16
Sinius	20
Intego	25
Intego Pro	27
Intego Ambidextrous	29



Accessories

LEDview Plus	32
Working Stools	33

Solutions for better, safer, faster dental care



Dentsply and Sirona have joined forces to become the world's largest provider of professional dental solutions. Our trusted brands have empowered dental professionals to provide better, safer and faster care in all fields of dentistry for over 100 years. However, as advanced as dentistry is today, together we are committed to making it even better. Everything we do is about helping you deliver the best possible dental care, for the benefit of your patients and practice.

Find out more on
dentsplysirona.com

Clinical Procedures

- Preventive
- Restorative
- Orthodontics
- Endodontics
- Implants
- Prosthetics

Platform Technologies

- CAD/CAM
- Imaging Systems
- Treatment Centers
- Instruments

THE DENTAL
SOLUTIONS
COMPANY™

 **Dentsply
Sirona**



TREATMENT CENTRES

Teneo

Innovation in perfect harmony

Teneo takes an uncompromising approach: Only the best is good enough. This makes Teneo our premium treatment centre, which meets the highest standards of intuitive operation, comfort and high-quality design. You can achieve a perfectly harmonious workflow if you and your treatment centre interact optimally. For this reason, Teneo responds automatically and individually to all your needs. Carefully selected features assist you in every treatment situation, down to the smallest detail. Comfort features ensure that your patients feel more relaxed throughout the treatment so you can focus entirely on your work.

This image shows the Teneo unit with various additional options.

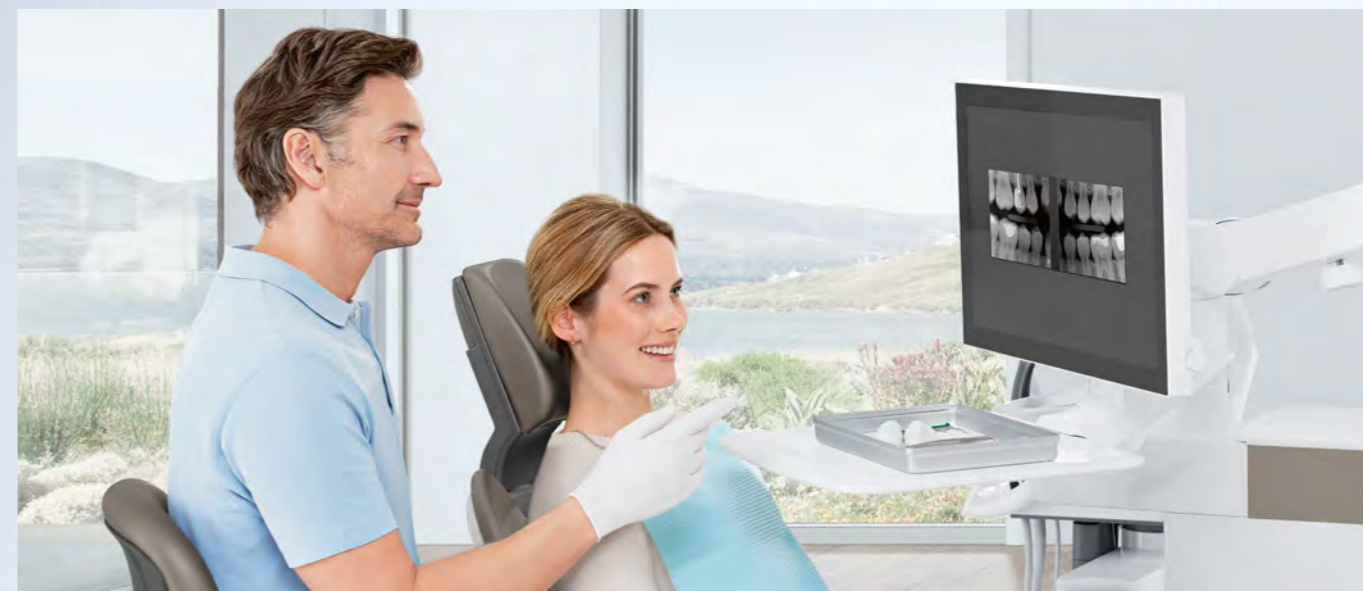

Why settle for less?

Motorised Functions

- Motorised sliding track - For an ergonomic working position, Teneo places everything you need at your fingertips, hands-free and effortless
- Motorised headrest - For optimum access to the treatment site, the extension and inclination of the motorised headrest can be adjusted
- Motorised cuspidor - For fast and safe procedures, the cuspidor is motorised and swivels in and out

Efficient

- 6 + 1 instrument positions - The extra instrument position allow you to configure the treatment centre, giving you even more ways to adapt it to your requirements
- 7" EasyTouch display - The large touchscreen ensures intuitive and self-explanatory operation and navigates safely and easily throughout the entire treatment
- Endodontics and implantology function - Integrated treatment functions for implantology and endodontics make setup times unnecessary
- Hands-free operation - The wireless foot switch is your multifunctional control element for all chair functions. It provides hands-free control of the EasyTouch display and the motorised sliding track

Premium

- ErgoMotion and OrthoMotion - Teneo provides ergonomic positioning and supports a needs-based posture for your patients in every treatment situation
- Excellent visibility - The LEDview Plus operating light can be optimally positioned and controlled hands-free via a sensor
- Lounge upholstery - Its innovative material gives this upholstery option additional softness for that extra bit of comfort
- Massage and lumbar-support function - A gentle anti-stress massage and the lumbar support functions help your patients relax



Motorised headrest
Adjust the headrest using the foot switch, the user interface, or even manually.



7" EasyTouch display
The large touchscreen is customisable and upgradeable. In easy mode, it shows only those functions you need at any given time.



Wireless foot switch
Control the EasyTouch display and the motorised sliding track with the touch of your foot.



LEDview Plus
This operating light provides a perfect mixture of light intensity, light colour, and light field size.

Teneo - Package structure

Two easy steps to your individual configuration

1 Select the standard unit

Teneo standard unit
6622828

Consisting of:

Patient chair

- With comfortable Thermo upholstery, motorised headrest, up to 4 programmable treatment positions, S and O position for up to 6 practitioners individually programmable
- Integrated 4-way foot switch and wireless multi-functional foot pedal for hands-free control of all functions
- Synchronised movements of backrest and seat (ErgoMotion), as well as tilting the entire chair without altering the angle between the seat and the backrest (OrthoMotion) is possible
- Backrest with integrated active lumbar support and massage functions
- Central junction box for all media and data lines integrated in the chair base
- Pre-wired for Sivation digital

Dentist element

- With motorised parallel movement, instrument holder with 6 positions that are detachable and thermally disinfectable
- User interface EasyTouch adapts to user preferences and built-in options
- Includes supply for three drill-drives and integrated USB interface
- Equipped with:
 - 1 turbine hose

Assistant element

- With 4 instrument positions, on a height-adjustable support arm with wide swivel range
- Equipped with:
 - 1 suction device
 - 1 saliva ejector
 - Suction volume can be preset by the technician

Water unit

- With integrated disinfection device with integrated sanitisation adapters for the spray water supply of all instruments and tumbler filler
- Integrated chemical suction hose cleaning system, with motorised swiveling glass cuspidor and tumbler filler
- Bowl flush and tumbler filling can be controlled from both dentist and assistant elements, and is mounted to the floor
- Standard equipment with cuspidor valve for central wet suction, optionally amalgam separator or automatic separator possible

2 Select one or more special-offer packages (below) and add individual options (on page 25).

Innovation

6445105

- Sprayvit M for the dentist and assistant elements
- 2 BL electric motors (extra charge for BL ISO C)
- SiroSonic TL ultrasonic handpiece
- LEDview Plus operating light
- Up to two Hugo or Carl working stools at a discounted price

Endo

6444561 Endo package for BL motor BL

6444579 Endo package for BL ISO C motor

- Endodontic treatment function
- ApexLocator assembly
- T1 Line Endo 6 L contra-angle handpiece with light
- Basic Apex adapter (optional)
- Holder for ApexLocator
- Additional option: Reciprocating file function

Implant

6444587

- Extended implantology function
- Integrated pump for saline solution
- BL Implant electric motor
- Implant contra-angle handpiece (20:1)

Sivation

6253574

- Monitor, 22"
- SiroCam AF+
- Monitor position on the tray or the light support column
- Camera connectivity in the dentist element



Individual options

This is a complete listing of the standard equipment for the basic unit and all available individual options. For part numbers and more detailed information, please contact your Dentsply Sirona representative.

Basic Equipment Options	Teneo	Basic Equipment Options	Teneo
Patient chair		Water unit	
Patient-specific chair positions*	•	Disinfection device with permanent disinfection and sanitation function	•
Motorised headrest with automatic patient-specific headrest adjustment*	•	Suction hose cleaning with chemicals	•
Premium Thermo upholstery	•	Hydrocolloid port	○
Lounge upholstery	○	Cuspidor valve for wet suction system	○
Lumbar support/massage function	•	Automatic separator	○
Removable armrest, right armrest can be swiveled to side	○	Amalgam separator	○
Removable left armrest	○	Glass cuspidor, motoric swivel function, removable	•
Four-way foot switch	•	Purge function with autopurge	•
Wireless foot control	•	Aqua function	•
External device connection	○		
Booster cushion for small patients	○	Sivation digital	
Adapter plate	○	SiroCam AF+	○
OrthoMotion	•	22" monitor on the tray, includes tray	○
ErgoMotion	•	22" monitor on the light support column	○
SlowMotion travel	•	Camera connector in the dentist element	○
		Cable set for PC connectivity	○
Dentist element (with EasyTouch, 6 positions, removable handles and instrument holder)		Working stools (long or short gas spring)	
Sprayvit M with light	○	Hugo Freehand (with foot release)	○
1st drill drive (for motor or turbine)	•	Hugo Manual (with manual release)	○
2nd drill drive (for motor without turbine)	•	Hugo Manual Plus (with manual release and foot ring)	○
3rd drill drive (for motor without turbine)	•	Hugo working stool (optional long or short gas spring)	○
4th drill drive (for motor without turbine)	○	Carl Manual (with manual release)	○
BL electric motor	○	Carl Manual Plus (with manual release and foot ring)	○
BL ISO C electric motor	○		
BL Implant electric motor	○	Additional Options	
Turbine hose	•	Sirona tray	○
SiroSonic TL ultrasonic handpiece	○	PC interface (Ethernet)	•
Sirotom electrosurgery kit	○	PC control with EasyTouch	•
Implantology function	○	Remote diagnostics	•
Endodontic treatment function	○	LEDview Plus operating light	○
Reciprocating file function	○	LEDview Plus ceiling light	○
ApexLocator with display on Sivation monitor	○	Adaptation for Heliodont Plus ceiling combination	○
Integrated pump for saline solution	○	Adaptation for Heliodont Plus unit model	○
USB port	•		
Hands-free operation with cursor control	•		
Contra-angle handpiece T1 Line Endo 6 L with light	○		
Contra-angle handpiece Implant 20:1	○		
Assistant element (with 4 positions, removable holder)		Key	
Satelec mini L.E.D. curing light	○	* Available with Sidexis 4	
Surgical suction device	○	• = Included in basic unit or as a package	
Sprayvit M with light	○	○ = Option	
Suction device	•		
Saliva ejector	•		
Suction hoses with slide	○		



Sinius

With more efficiency for greater balance in practice routine

As time is one of our most valuable assets, it's a good thing we have Sinius. The development of efficient solutions allows you to make optimal use of your time. The Sinius treatment centre is not only ultra-compact, it includes manual parallel movement of the dentist element for efficient work, and delivers clear gains in terms of time and flexibility. The intuitive operation with the latest touchscreen technology and numerous integrated functions ensure this.

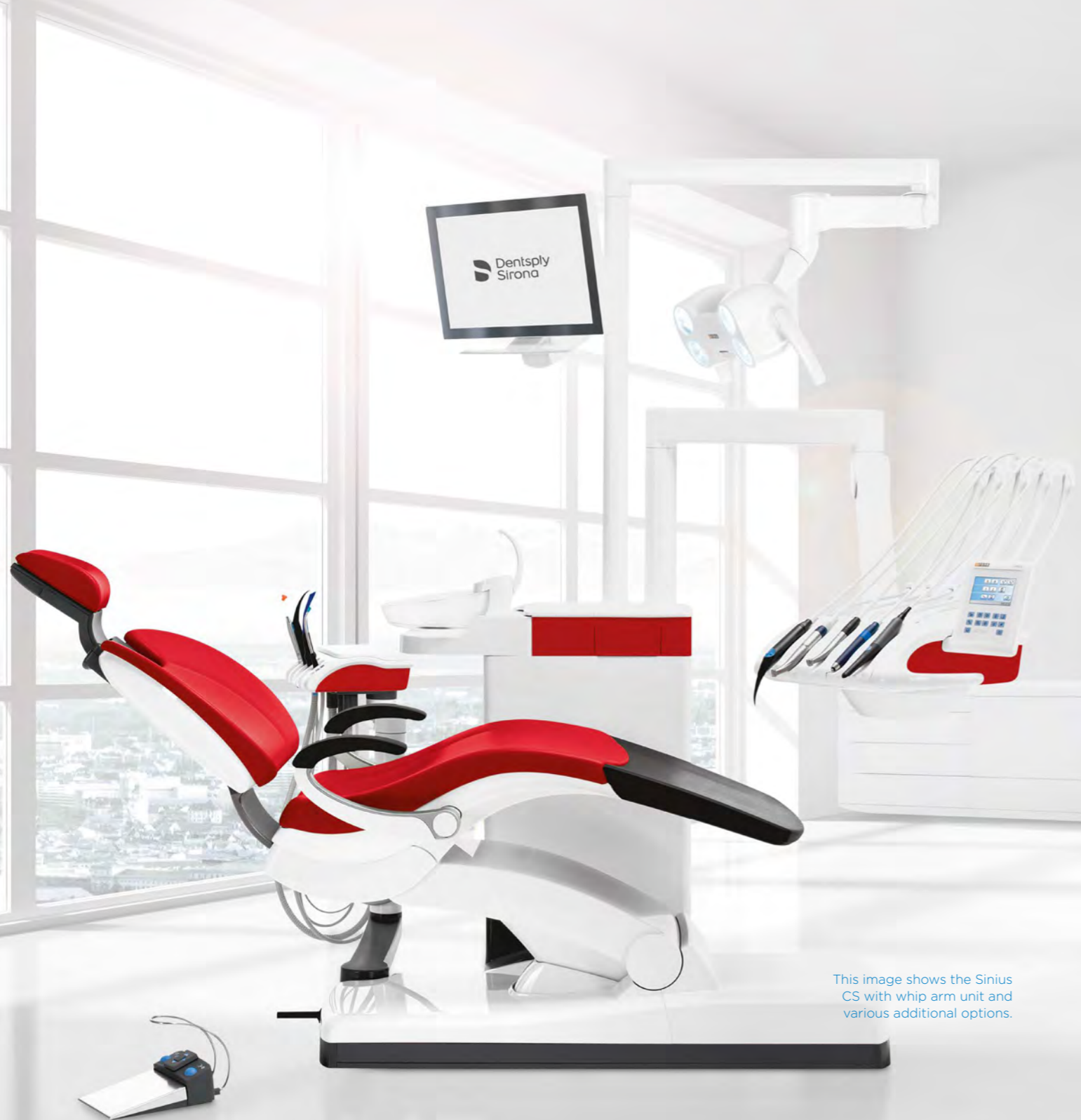

This image shows the Sinius CS with whip arm unit and various additional options.



Benefits at a glance:

Efficient

- Integratable treatment packages for implantology and endodontics
- Integrated hygiene function
- Individual price/performance ratio
- Operating light - LEDview Plus
- ErgoMotion - Synchronised movements of the backrest and seat prevent the overextension or compression of the patient's spine

Intuitive

- User-friendly EasyTouch interface
- Multi-function foot pedal, optionally wireless
- Access to PC functions directly via EasyTouch and foot pedal
- Choice of three treatment concepts that fit your personal methods

Compact

- Optimal use of space
- Unique chair lift system
- Flexible positioning of dentist and assistant element

With three treatment concepts, Dentsply Sirona has the right treatment centre for every work method.

Sinius - The sliding track design

- Unique ergonomic treatment concept
- Dentist element can be easily moved forward and backward manually
- Swivel-mounted dentist element ensures everything is at your fingertips

Sinius CS - The whip arm design

- Dentist element can be rotated by up to 240° for optimal positioning
- Maximum distance between the dentist element and instruments is 90cm
- Ideal for the widest range of treatment situations for working alone or with a team

Sinius TS - The OTP arm design

- Ergonomic positioning with independently movable dentist element and tray system
- Functional tray system with detachable tray that can be positioned very flexibly
- Large areas on dentist element and tray



Sinius with sliding track



Sinius with whip arm



Sinius with OTP support arm



This image shows the Sinius with sliding track unit and various additional options.



Sinius - Package structure

Three easy steps to your individual configuration

1 Select the standard unit

- 6308865* Sinius standard unit with sliding track
 6308873* Sinius CS standard unit with whip arm
 6408822* Sinius TS standard unit with OTP support arm

*without cuspidor valve nor disinfection device

Consisting of:

Patient chair

- With comfortable upholstery, double-articulating headrest, 2 programmable treatment positions, S and O position for up to 6 practitioners individually programmable
- Integrated 4-way foot switch. Synchronised movements of backrest and seat (ErgoMotion)
- Central junction box for all media and data lines integrated in the chair base

Dentist element

For Sinus Standard:

- With manual parallel movement, instrument holder with 5 positions that are detachable and thermally disinfectable
- User interface EasyTouch adapts to user preferences and built-in options
- Includes supply for two drill-drives

For Sinius CS Standard:

- With whip arms on a height-adjustable, articulated support arm, instrument holder with 5 positions, detachable and thermally disinfectable
- User interface EasyTouch adapts to user preferences and built-in options
- Includes supply for two drill-drives

For Sinius TS Standard:

- With hanging hoses on an individually positionable, height-adjustable support-arm. Instrument holder with 5 positions that are detachable and thermally disinfectable
- User interface EasyTouch adapts to user preferences and built-in options
- Includes supply for two drill-drives

Assistant element

- With 4 instrument positions, on a support arm with wide swivel range
- Equipped with:
 - 1 suction device
 - 1 saliva ejector
 - Suction volume can be preset by the technician

Water unit

- With swiveling glass cuspidor and tumbler filler
- Bowl flush and tumbler filling can be controlled from both dentist and assistant element
- Mounted to the floor. Integrated water flush suction hose cleaning

2 Select the user package:

Start

6444926

- Sprayvit M in the dentist element
- BL ISO E motor
- LEDview Plus

Innovation

6444942

- Sprayvit M in the dentist and assistant element
- 2 BL motors (surcharge for BL ISO C)
- SiroSonic TL

- LEDview Plus
- Wireless foot control

Advance

6444934

- Sprayvit M in the dentist element
- 1 BL motor (surcharge for BL ISO C)
- SiroSonic TL
- LEDview Plus
- Wireless foot control

3 Add your option packages or individual options below

Endo

- 6444819 Endo Package for BL motor
 6444827 Endo Package for BL ISO C motor
- Endodontic treatment function
 - ApexLocator
 - Holder for the ApexLocator
 - T1 Line Endo 6L contra-angle handpiece with light
 - ISO adapter with light (optional)
 - Upgrade to BL or BL ISO C motor (required only in combination with the Start package)
 - Additional option: Reciprocal file systems

Comfort

6253277

- 1st working stool (free selection of version)
- 2nd working stool at a package price
- Motor-driven headrest
- Lumbar support function
- Premium thermo upholstery
- Also available with Lounge upholstery (instead of Premium thermo upholstery)

Implant

6444769

- Implantology function
- Integrated pump for saline solution
- BL Implant electric motor
- Implant 20:1 contra-angle handpiece

Sivision

- 6253350 Sivision package for camera in the dentist element
 6253400 Sivision package for camera in the assistant element
- 22" monitor
 - Freely selectable monitor position
 - SiroCam AF or optional SiroCam AF+
 - Camera supply in the dentist element

Individual options

Here you will find the complete list of all individual options, and see which equipment is already part of the basic units. For part numbers and more detailed information, please contact your Dentsply Sirona representative.

Basic Equipment Options	VB	CS	TS	Basic Equipment Options	VB	CS	TS
Patient chair				Water unit			
Double articulating headrest	•	•	•	Disinfection device with permanent disinfection and sanitisation function	•	•	•
Motor-driven headrest	•	•	•	Suction hose cleaning with water	•	•	•
Premium upholstery	•	•	•	Suction hose cleaning with chemicals	•	•	•
Premium thermo upholstery	•	•	•	Cuspidor valve for wet suction system	•	•	•
Lounge upholstery	•	•	•	Automatic separator	•	•	•
Lumbar support function	•	•	•	Amalgam separator	•	•	•
Swiveling armrest, right or left	•	•	•	Swiveling cuspidor	•	•	•
4-way foot control	•	•	•	Without cuspidor	•	•	•
Foot control, cable version	•	•	•	Tray with clip-on tray and handle	•	•	•
Wireless foot control	•	•	•				
External device connection	•	•	•	Sivision digital			
Booster cushion for small patients (C seat cushion)	•	•	•	SiroCam AF	•	•	•
Installation plate to level out uneven floors	•	•	•	SiroCam AF+	•	•	•
				22 monitor on the tray incl. tray	•	•	•
Dentist element (5 handpiece positions, removable handle and instrument holder)							
Sprayvit M syringe with light	•	•	•	22 monitor on the light support frame	•	•	•
1st drive (for motor or turbine)	•	•	•	Additional holder for camera	•	•	•
2nd drive (for motor or turbine)	•	•	•	Camera power supply in the dentist element	•	•	•
3rd drive (for motor or turbine)	•	•	•	Camera supply in the assistant element	•	•	•
BL electric motor	•	•	•	Sivision ready installation kit with USB interface	•	•	•
BL ISO C electric motor	•	•	•	Cable set for PC connection	•	•	•
BL ISO E electric motor	•	•	•				
BL Implant electric motor	•	•	•	Hugo working stool (optional long or short gas spring)			
Implant 20:1 contra-angle handpiece	•	•	•	Hugo Freehand (with foot release)	•	•	•
Turbine hose	•	•	•	Hugo Manual (with manual release)	•	•	•
SiroSonic TL ultrasonic handpiece	•	•	•	Hugo Manual Plus (with manual release and foot ring)	•	•	•
Hands-free operation with cursor control	•	•	•				
Implantology function	•	•	•	Carl working stool (optional long or short gas spring)			
Saline solution pump	•	•	•	Carl Manual (with manual release)	•	•	•
Endodontic treatment function	•	•	•	Carl Manual Plus (optional long or short gas spring)	•	•	•
Contra-angle handpiece T1 Line Endo 6 L with light	•	•	•				
				Operating light/Heliident Plus options			
Reciprocal file systems	•	•	•	LEDview Plus operating light (triple-jointed support arm, with sensor)	•	•	•
ApexLocator function with display on the Sivision monitor	•	•	•	LEDview Plus ceiling mode	•	•	•
Swiveling tray holder for 1 or 2 standard size trays	•	•	•	LEDview Plus / Heliident Plus ceiling combination	•	•	•
Panoramic X-ray image viewer	•	•	•	Adapter for Heliident Plus unit model	•	•	•
Assistant element (with 4 positions, removable holder, and silicone mat)							
Satelec mini LED curing light	•	•	•	Key			
Surgical suction device	•	•	•	VB = Sinius (sliding track version)			
2nd HVE kit	•	•	•	CS = Sinius CS (whip arm version)			
Sprayvit M syringe with light	•	•	•	TS = Sinius TS (OTP version)			
Suction device	•	•	•	• = Included in basic unit			
Saliva ejector	•	•	•	○ = Option			



TREATMENT CENTRES

The Intego Family

The best treatment centres of their class

Your work day is complex and places many different demands on the treatment centre you choose. Intego gives you the perfect solution: Choose from three models that you can configure flexibly. Whether you select an **Intego**, an **Intego Pro** or an **Intego Ambidextrous**, every option offers optimal performance at a fair price.

Benefits at a glance:

- Great value - Excellent performance and innovative functions at a great price
- Ergonomic design - Designed for intuitive handling and optimised, integrated workflows
- Quality made in Germany - Defined quality assurance processes, durable materials, and sturdy, future-proof design
- Customised settings to add to your comfort - Configure your Intego model of choice exactly the way you need for optimal support of your treatment workflow, and with technical options and interfaces so you are ready for future applications
- Dentist element - Available as the TS model with

hanging hoses (Traditional Style) or CS with whip arms (Continental Style)

- The hanging hoses model has an ergonomic positioning of the dentist element due to a wide range support arm system. It has a functional tray system with a detachable tray that can be positioned flexibly. It also has an integrated, comprehensive infection prevention concept for optimal results
- The whip arm design is ideal for the widest range of treatment situations with four-handed or two-handed dentistry. The dentist element can be rotated by up to 240° for optimal positioning. The maximum distance between the dentist element and instruments is 90cm

NEW: Dentsply Sirona's unique ErgoMotion for the Intego family

Benefits:

- Better positioning for maxillar or mandibular treatment
- Less overstretching of patient's head
- No overstretching and compressing of patient's spine
- No readjustment of headrest necessary



TREATMENT CENTRES

Intego

Your reliable partner

Intego is based on the innovative power and award-winning design of our existing treatment centres. As a reliable partner for an efficient practice, Intego has all the features that provide optimal support: Ergonomic design for better workflows, high quality standards in processing and design, and a great value. This is why Intego is our performance class.

Benefits at a glance:

- Treatment centre with a compact water unit for optimal use of space
- EasyPad user interface for easy, intuitive operation
- Choice of two headrests: The flat headrest can be adjusted quickly and flexibly. Optionally, you can select a double articulating headrest that is easier to position and allows you optimal visibility
- Two operating light options: Our premium operating light LEDview Plus, or alternatively choose our LEDlight
- Assistant element: Comfort or Compact. Both assistant elements are very space-saving and ensure maximum freedom of movement
- Controlled water quality with a self-contained fresh water supply bottle
- Dentist element: Available as the TS model with hanging hoses (Traditional Style) or CS with whip arms (Continental Style)



Fresh water bottle
For controlled water quality. Can also be filled with Dentosept P solution for permanent disinfection and manual sanitisation.



Smooth surfaces
The largely gap-free design of the surfaces ensures maximum infection control in the shortest time possible.



This image shows the Intego TS model with hanging hoses and various additional options

Intego - Package structure

Three easy steps to your individual configuration

1 Select the standard unit with TS or CS dentist element

Intego standard unit

6427285

Consisting of:

Patient chair

- Premium upholstery
- Flat headrest
- Pneumatic instrument foot control

Assistant element

- Compact version on a swivel arm directly mounted to the cuspidor
- 4 handpiece positions
- Saliva ejector and HVE

Dentist element

- 5 instrument positions
- EasyPad user interface
- Supply for 2 drill drives

Water unit

- Compact design
- Standard wet suction
- Ready for the integration of a fresh water bottle
- Cuspidor with manual swivel function

- 6454842 Dentist element TS with hanging hoses (Traditional style)
6454834 Dentist element CS with whip arm type (Continental style)

2 Select the user package:

Start

6444371

- Standard 3-way syringe
- Light source in the dentist element
- 2 turbine hoses
- LEDlight*

Advance

6444389

- C+ electronic foot control
- Sprayvit E in the dentist element
- Light source in the dentist element
- 1 turbine hose
- 1 BL ISO E micro-motor with supply electronics
- LEDlight*

Ergo

6444991

- ErgoMotion
- Chair lift system 185kg
- 2 armrests
- Double articulated headrest

Innovation

6444959

- C+ electronic foot control
- Sprayvit E in the dentist element
- Light source in the dentist element
- 1 turbine hose
- 1 BL ISO E micro-motor with supply electronics
- Sirosonic L scaler
- LEDview Plus

Endo Pro**

6253848

- Integrated torque control
- ApexLocator
- Endo 6:1 contra-angle handpiece
- e-Control

* LEDview Plus available at an additional charge

** Only with EasyTouch

3 Add your option packages (below) or individual options (on page 36)

Sivision Ready

6253855 For dentist element
6253863 For assistant element

- USB interface for the dentist or assistant element
- Network interface

Sivision Start

6253889 With monitor (dentist element)
6444348 With monitor (assistant element)
6253871 Without monitor (dentist element)
6253905 Without monitor (assistant element)

- USB interface for the dentist or assistant element
- Network interface
- SiroCam F (SiroCam AF or AF+ at additional charge)
- Monitor mount on the light support column
- Optional: 22" AC monitor



TREATMENT CENTRES

Intego Pro

Performance you can rely on

The treatment centre is the heart of your practice. Perfectly combine appearance and functionality so you can work comfortably under optimal conditions. The Intego Pro's harmonious design, coordinated components and variety of colour combinations, gives you the flexibility and the perfect solution you need. Intego Pro fits the style of your practice - and your taste.

Benefits at a glance:

- Integrated, comprehensive hygiene concept for optimal results
- EasyTouch touchscreen and integrated foot control concept for easy, intuitive operation
- Flexible assistant element suitable for two- or four-handed treatment
- Numerous equipment options with a great value
- Choice of two headrests: The flat headrest can be adjusted quickly and flexibly. Optionally, you can select a double articulating headrest that is easier to position and allows you optimal visibility
- Two operating light options: Our premium operating light LEDview Plus, or alternatively choose our LEDlight
- Assistant element: Comfort or Compact. Both assistant elements are very space-saving and ensure maximum freedom of movement
- Dentist element: Available as the TS model with hanging hoses or CS with whip arms



Integrated disinfection system

Permanent disinfection of all water lines with Dentosept P. Automatic sanitising function for regular intensive disinfection.



Cuspidor

Removable and swiveling, made of high-quality glass.



This image shows the Intego Pro TS model with hanging hoses and various additional options.

Intego Pro - Package structure

Three easy steps to your individual configuration

1 Select the standard unit with TS or CS dentist element:

Intego Pro standard unit

6427277

Consisting of:

Patient chair

- Premium upholstery
- Pneumatic instrument foot control
- Flat headrest
- 4-way foot switch

Dentist element

- 5 instrument positions
- EasyPad user interface
- Supply for 2 drill drives
- Instrument light source
- Supply electronics for up to 2 motors and scaler

Assistant element

- Compact version on a swivel arm directly mounted to the cuspidor
- 4 handpiece positions
- Saliva ejector and HVE
- Light source for Sprayvit E

Water unit

- Ready for the integration of an automatic disinfection device
- Integrated cleaning adapters
- Cuspidor with manual swivel function
- Wet suction with multi-station valve
- Integrated water flush suction hose cleaning
- Water heater

- 6454842 Dentist element TS with hanging hoses (Traditional style)
6454834 Dentist element CS with whip arm type (Continental style)

2 Select the user package:

Start Pro

6253814

- C+ electronic foot control
- Sprayvit E in the dentist element
- 1 turbine hose
- 1 BL ISO E micro-motor
- LEDlight*

Advance Pro

6444967

- C+ electronic foot control
- Sprayvit E in the dentist element
- 1 turbine hose
- 1 BL ISO E micro-motor
- SiroSonic L scaler
- EasyTouch user interface
- LEDview Plus

Innovation Pro

6444975

- C+ electronic foot control
- Sprayvit E in the dentist element
- Third drill drive
- 1 turbine hose
- 2 BL ISO E micro-motors
- SiroSonic L scaler
- EasyTouch user interface
- Sprayvit E in the assistant element
- LEDview Plus

Endo Pro**

6253848

- Integrated torque control
- ApexLocator
- Endo 6:1 contra-angle handpiece
- e-Control

* LEDview Plus at an additional charge

** Only with EasyTouch

3 Add your option packages (below) or individual options (on page 36)

Sivision Ready

6253855 For dentist element
6253863 For assistant element

- USB interface for the dentist or assistant element
- Network interface

Sivision Start

6253889 With monitor (dentist element)
6444348 With monitor (assistant element)
6253871 Without monitor (dentist element)
6253905 Without monitor (assistant element)

- USB interface for the dentist or assistant element
- Network interface
- SiroCam F (SiroCam AF or AF+ at additional charge)
- Monitor mount on the light support column
- Optional: 22" AC monitor



TREATMENT CENTRES

Intego Ambidextrous

Turning with perfection

Our era is marked by rapid progress. At Dentsply Sirona, we want to give you even more flexibility so that you will be able to react optimally to your needs and those of your patients, both now and in the future. To ensure this, we developed the Intego Ambidextrous treatment centre. Intego Ambidextrous is designed for right and left-handed dentists who want optimal ergonomics without treatment compromises. This treatment centre gives you the option of changing the treatment position easily and smoothly. The unique rotation mechanism makes it possible to convert the treatment centre from a right-handed to a left-handed position in just 15 seconds, making it very flexible, particularly in group practices. Whether you select an Intego Ambidextrous or Intego Pro Ambidextrous, or a treatment centre with hanging hose (TS) or a whip arm (CS) design, every option offers optimal performance at a reasonable price.

Benefits at a glance:

- **Intuitive** - More freedom of movement and optimal instrument placement
- **Fast** - Due to the intelligent mechanism design, the treatment position can be switched in just 15 seconds
- **Easy** - There is no need for special training, the process can be intuitively handled by your team. The swivel mechanism is released with just one click on the foot pedal and the backrest travels automatically into the correct position
- **Elegant** - The treatment centre can be converted smoothly and effortlessly in a single flow. No jerky movements, no screws, no assembly
- **No extra space needed** - The intelligently designed rotating mechanism enables compact and space-saving movement at all times in every phase. During the movement process, the treatment centre remains completely stable in all positions. The water unit is guided safely and in a controlled manner around the backrest, which rules out the risk of damage
- **Comfortable positioning** - For both the dentist and the patient
- **Optimal visibility** - With the LEDlight and the LEDview Plus lights



The turn process is activated by a single step on the respective foot pedal.



The water unit smoothly moves behind the backrest, and the dentist element and OP light can be simultaneously swiveled to the new position.



Intego Ambidextrous version - 6444702
Intego Pro Ambidextrous version - 6444710



Scan and connect digitally. Or treat it in a single visit. **Either way, it's prime.**

Enjoy the scan.

With the connectivity options of Primescan.

The Intego Family Individual Options

Here you can view the complete list of individual options, and a checklist of what is included with the Intego and Intego Pro standard units. For part numbers and more detailed information, please contact your Dentsply Sirona representative.

	Intego	Intego Pro		Intego	Intego Pro
Patient chair			Assistant element		
2 treatment positions, S and O position	•	•	Compact assistant element, swivel mounted directly on the cuspidor arm	•	•
Integrated junction box	•	•	Comfort assistant element, ideal for two-handed dentistry	•	•
Chair lift system 140 kg	•	-	4 instrument positions	•	•
Chair lift system 185 kg	○, Er	•	Saliva ejector and HVE	•	•
Flat headrest	•	•	Sprayvit E with light	○, I	○, I
Double articulating headrest	○, Er	○	Sprayvit E with light (water button on the left)	○	○, I
Premium upholstery	•	•	Standard 3-way syringe	○	-
Lounge upholstery	○	○	2nd HVE kit	○	○
ErgoMotion	○, Er	○	Satelec Mini LED curing light	○	○
4-way foot switch	○	•	Touch pad	○	○
Booster cushion for small patients	○	○	Light source for Sprayvit E	○	•
Right armrest	○, Er	○	Silicone pad for Comfort assistant element	○	○
Left armrest	○, Er	○			
Valve set for external devices	○	○	Water unit		
Vacuum pressure reduction kit	○	○	Prepared for fresh water bottle	•	-
Cover installation kit	○	○	Prepared for integrated disinfection device	-	•
Separate junction box	○	○	Cuspidor with manual swivel function	•	•
Adapter plate	○	○	White cuspidor	-	•
			Glass cuspidor	-	•
Dentist element			Water unit without cuspidor	○	○
Height-adjustable support arm with pneumatic brake	•	•	Prepared for standard wet suction	•	-
5 instrument positions	•	•	Prepared for standard wet suction w/automatic suction control	○	-
Additional camera holder for TS dentist element	-	○	Multi-station valve for standard wet suction	○	•
Hydro-pneumatic supply for 2 drill drives w/o fiber optics	•	•	Cuspidor valve for standard wet suction	○	○
Pneumatic instrument foot control	•	•	Automatic separator	○	○
C+ electronic foot control	○, A, I, T	○, S, A, I	Amalgam separator	○	○
EasyPad user interface with 2 user-specific settings	○	○	Fresh water bottle w/o switch to public water supply	○	-
EasyTouch user interface with 4 user-specific settings	○, T	○, A, I	Fresh water bottle with switch to public water supply	○	-
			Integrated disinfection system with permanent waterline disinfection and automatic sanitization function	-	○
Sprayvit E with light	○, A, I	○, S, A, I	Water heater	○	•
Sprayvit E with light (water button on the left)	○, A, I	○, S, A, I	Water flush suction hose cleaning system	○	•
Standard 3-way syringe	○ S	-			
			Chemical suction hose cleaning system	-	○
Turbine hose with light	○, 2xS, A, I, T	○, S, A, I			
Borden turbine hose	○	-	Operating light options/Heliodont Plus options		
1st BL ISO E motor with hose	○, A, I, T	○, S, A, I	LEDlight	○, S, A	○, S,
2nd BL ISO E motor with hose	○	○, I	LEDview Plus	○, I, T	○, A, I
SiroSonic L scaler	○, I	○, A, I	Adaptation for LEDview Plus/Heliodont Plus ceiling combination	○	○
Third drill drive	○	○, I	Adaptation for Heliodont Plus unit model	○	○
Satelec Mini LED curing light	-	○			
Intra-oral light source kit for turbine and Sprayvit E	○, S, A, I, T	•	Patient communication		
Torque control for endodontic treatments	○, E	○, E	USB interface in the dentist or assistant element	○, SIR, SIS	○, SIR, SIS
eControl: Speed range of 100 - 40,000 rpm	○, E	○, E	SiroCam F	○, SIS	○, SIS
Integrated ApexLocator	○, E	○, E	SiroCam AF	○	○
Endo 6:1 contra-angle handpiece	○, E	○, E	SiroCam AF+	○	○
Intra-oral X-ray viewer	○	○	Monitor mount on the light support column	○, SIS	○, SIS
Purge and manual sanitization function	○	-	22" AC monitor (with integrated power supply unit)	○, SIS*	○, SIS*
Purge and Autopurge	-	•	Network interface	○, SIR, SIS	○, SIR, SIS
Flexible TS tray holder for 2 standard size trays	○	○			
Flexible TS camera holder	○	○			
Silicone pad for TS dentist element	○	○			
Additional CS tray holder for 1 standard size tray	○	○			
Additional CS tray holder for 2 standard size trays	○	○			
Silicone pad for CS dentist element	○	○			
Removable silicone sleeves for handles	○	○			

Key
 • = Included in basic unit
 ○ = Option
 - = Not possible / applicable
 SIR = Sivation Ready package
 SIS = Sivation Start package
 SIS* = Sivation Start package with
 S = Start / Start Pro package
 A = Advance / Advance Pro package
 I = Innovation / Innovation Pro package
 E = Endo Pro package
 Er = Ergo package
 T = Touch Plus package

Find out more on dentsplysirona.com/primescan



TREATMENT CENTRES / ACCESSORIES - OPERATING LIGHT

LEDview Plus

The better you see, the more you detect

Excellent visibility is a basic prerequisite to ensure the best possible diagnosis and subsequent treatment. LEDview Plus, the premium operating light from Dentsply Sirona, performs with the perfect interplay of light intensity, light colour and light field size.

Benefits at a glance:

- Homogenous illumination similar to daylight (seven brightness levels and three colour temperature levels)
- Perfect light characteristics due to mix of multi-colour LED units so both the gingiva and hard tooth substance look exceptionally natural
- 3 axes of rotation for flexible positioning
- Ergonomic and modern design
- Long-life LEDs eliminate the need for bulb replacement
- High efficiency and low power consumption
- No cooling fan required
- Composite mode allows for a targeted reduction of blue light components preventing premature hardening
- Hands-free control via sensor for on/off



Technical Data

- Input volt: 24-36VDC
- Power consumption: 36W
- Light field: approx. 200mm x 100mm at a distance of 700mm

- Illumination intensity: approx. 5,000 - 40,000lux
- Colour temperature: approx. 4,600 - 6,200K
- Colour rendering: CRI: 95* at 5,400K

Unit model or ceiling model? Your choice!

6497239	LEDview Plus unit model including operating light and monitor 22" (does not include a support column)
6489624	Heliodent Plus unit model on the treatment centre
6571272	Ceiling model LEDview Plus
6602234	Ceiling model Heliodent Plus

According to the desired configuration, the following items are available:

6388370	Standard light support column
6467711	Light support column with adaption for Heliodent Plus unit model
6542372	Light support column with adaption for monitor 22" retrofit kit
6542380	Light support column with adaption for monitor 22" and Heliodent Plus unit model retrofit kit
6474089	Fixation kit for mounting post (required if there is no light support column yet installed)
6445162	Adaptation for Heliodent Plus ceiling mode

Accessories

6497353	Handle sleeves for LEDview Plus - Sterilisable (2 per pack)
6598267	Handle sleeves for LEDview Plus - Sterilisable (4 per pack)
6528017	Mirror for LEDview Plus
6572122	Camera adaptation for LEDview Plus

Try me with...

Heliodent Plus

The LEDview Plus ceiling model is available as a single ceiling light or as a ceiling combination with Heliodent Plus that not only creates optimal viewing conditions but also enables you to take intraoral images directly on your treatment unit. See pages 56-57



TREATMENT CENTRES / ACCESSORIES - WORKING STOOL

Paul

Simply a seat

Comfortable working stool with circular seat upholstery. The rotatable backrest may also be used as body support. Available in two seat heights.

- Circular seat cushion with comfortable upholstery
- Backrest swivels up to 90°
- Manual release mechanism for the height adjustment
- Optional foot ring caters for users of different sizes
- Choice of two gas spring lengths for different heights

Working stool Paul without upholstery

6313014	For users from 1.70m to 2.05m in height
6312883	For users from 1.50m to 1.80m in height

Foot ring for working stool Paul

6316066	For users from 1.70m to 2.05m in height
6316058	For users from 1.50m to 1.80m in height

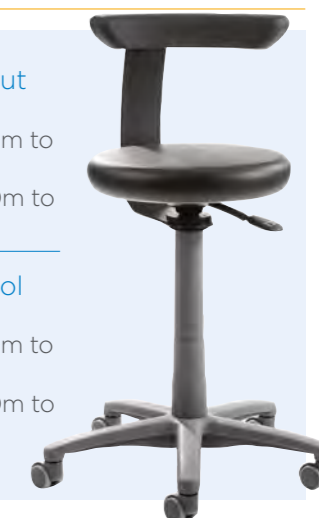

TREATMENT CENTRES / ACCESSORIES - WORKING STOOL

Hugo

The ergonomics expert

The working stool for dentist and assistant that supports maintaining an intuitive ergonomic sitting position. To suit the individual users' sizes and working habits, it is available in several variations.

- Innovative design and intelligent shape for more comfort when sitting
- OptiMotion supports your natural movements
- Thermo upholstery ensures your comfort when sitting
- The high-tech seat upholstery dissipates body heat. This means that you stay cool even during prolonged treatment sessions
- Choice of two gas spring lengths for different heights

Variations of Hugo working stool

6228634	Working stool Hugo
6204072*	Hugo Freehand with foot release
6204080*	Hugo Manual with manual release
6204098*	Hugo Manual Plus with manual release and foot ring



TREATMENT CENTRES / ACCESSORIES - WORKING STOOL

Carl

The all-rounder

The Carl round stool ensures maximum freedom of movement and meets the highest demands in comfort and quality. The round seat features comfortable upholstery and is "seamlessly" hygienic.

- Round seat with comfortable upholstery
- Height can be adjusted from any sitting position
- The backrest can be rotated 360° - Can be used as an armrest or lumbar support
- Choice of two gas spring lengths for different heights

Variations of Carl working stool

6313253	Working stool Carl
6253202*	Carl Manual with 360° manual release
6253210*	Carl Manual Plus with 360° manual release and foot ring



*At no extra charge, you can choose between two different gas springs for all working stools. This allows you to select the ergonomically correct stool height for your height.

6204056 for users from 1.70m to 2.05m in height
6204064 for users from 1.50m to 1.80m in height

Imaging Solutions from Dentsply Sirona

See more. Do more.

To date we have delivered more than 100,000 dental X-ray units to practices around the world and hold a number of patents in the field of imaging. Which is why we believe in order to provide the best for our customers and their patients, we need to continue discovering new and better ways to improve the way that we approach dentistry. And at the foundation of all of this are the three key principles that we view as the heart of Dentsply Sirona Imaging: [Clinical Confidence](#), [Smart Connectivity](#) and [Exceptional Experience](#).



Contents



Extraoral Imaging

2D X-Ray Units	
Orthophos E	38
<hr/>	
2D/3D X-Ray Units	
Orthophos S	40
Orthophos SL	42
<hr/>	
Orthophos Overview	44
<hr/>	
Axeos	46
<hr/>	
X-Ray Unit Accessories	48

Intraoral Imaging

Sensors and Scanner	
Xios XG Supreme	51
Xios AE	53
<hr/>	
X-Ray Units	
Heliodent Plus	56

Software

Sidexis 4	58
SICAT Implant	60
SICAT Air	61
SICAT Function	61
SICAT Endo	62



Imaging Consumables

Radiography Holders - Disposable	
Uni-Grip®	64
Uni-GripAR® Positioning Arm & Ring	64
<hr/>	
Radiography Holders - Autoclavable	
XCP-DS Fit® Universal Digital Sensor Holders	65
XCP® Extension Cone Paralleling System	66
XCP-ORA® One Ring	
& Arm Positioning System	67
Snap-A-Ray® DS Universal	
Digital Sensor Holder	68
Snap-A-Ray® Xtra Film	
& Phosphor Plate Holder	68
Eezee-Grip® Universal Digital Sensor Holder	69
Rinn® Flip-Ray® PA-Periapical,	
Rinn® Flip-Ray® BW-Bitewing	69
EndoRay® II Film Holder	70
<hr/>	
Disposables	
Digital Sensor Cover Bags	70
Disposable XCP® Biteblock	70
<hr/>	
Radiation Protection	
Rinn® Universal Collimator	72



EXTRAORAL IMAGING / 2D IMAGING SYSTEM

Orthophos E

The preferred 2D X-ray device

The entry-level unit provides a smooth entrance into the world of digital imaging through reliable diagnostics, thanks to Csl sensor technology and easy operation. The cephalometric option also makes the Orthophos E a reliable partner for orthodontics. Enrich your practice with a wide range of offerings that are only possible with digital imaging.

For a smooth entrance into digital imaging

Services and Functions:

1

2D Csl sensor

For an accurate diagnosis, thanks to reliable image quality

2

Important 2D programs

For comprehensive diagnostics with a motorized collimator, allowing for true pediatric programs

3

Safe and proven patient positioning

With motorized temple and forehead supports, automatic temple width measurement, light localizers and sturdy handles

4

Ceph arm (left)

This can be ordered at the time of purchase or can be retrofitted at any time

5

MultiPad control panel

For clear and simple operation

Orthophos E

6707488 Orthophos E
6708429 Orthophos E Ceph left (1 sensor)
6708429_2 Orthophos E Ceph left (2 sensors)

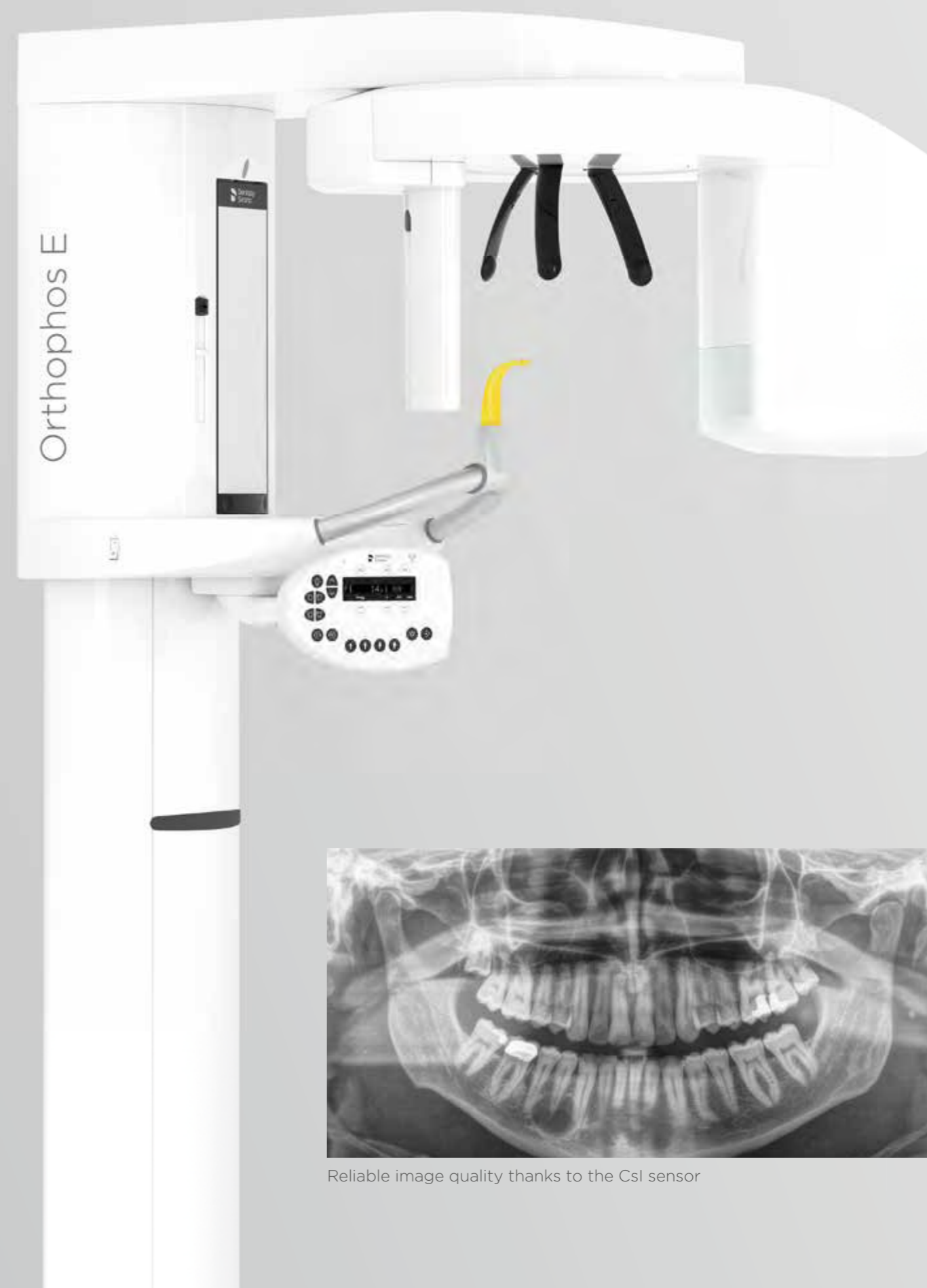

Reliable image quality thanks to the Csl sensor



EXTRAORAL IMAGING / 2D/3D IMAGING SYSTEM

Orthophos S

The high-quality 2D/3D X-ray unit with a comprehensive range of services for every practice

Whether used as a pure 2D device or including a 3D module - the Orthophos S is a reliable partner and optimized for daily practice tasks. Thanks to the CSI Plus sensor with autofocus function, you are assured sharp images every time, even in anatomically difficult cases. The patented occlusal bite block assures proper patient positioning and accurate imaging. For use in orthodontics, the Orthophos S is also available with an optional cephalometric arm. And because future-proofing is a priority at Dentsply Sirona, the cephalometric arm and 3D upgrade can be retrofitted at any time.

Optimized for the everyday tasks in your practice

Services and Functions:

- 1 2D CSI Plus sensor with autofocus function**
 For sharp, detailed images, even in anatomically difficult cases
- 2 Coordinated volume sizes**
 From Ø 5 cm x 5.5 cm to Ø 11 cm x 10 cm
- 3 Low Dose and HD function**
 3D imaging in the dose range of a 2D X-ray, HD images with up to 80 µm resolution
- 4 Patented occlusal bite block for automatic positioning**
 Maximum consistency and reproducibility, thanks to automatic patient positioning
- 5 Ceph arm on the left or right**
 This can be ordered at the time of purchase or can be retrofitted at any time
- 6 Safe and proven patient positioning**
 With motorized temple and forehead supports, automatic temple width measurement, light localizers and sturdy handles

Orthophos S

6679646	Orthophos S 2D
6473123	Ceph arm left, complete
6473438	Ceph arm right, complete
6679620	Orthophos S 3D 8x8
6679638	Orthophos S 3D 11x10
6473123	Ceph arm left, complete
6473438	Ceph arm right, complete

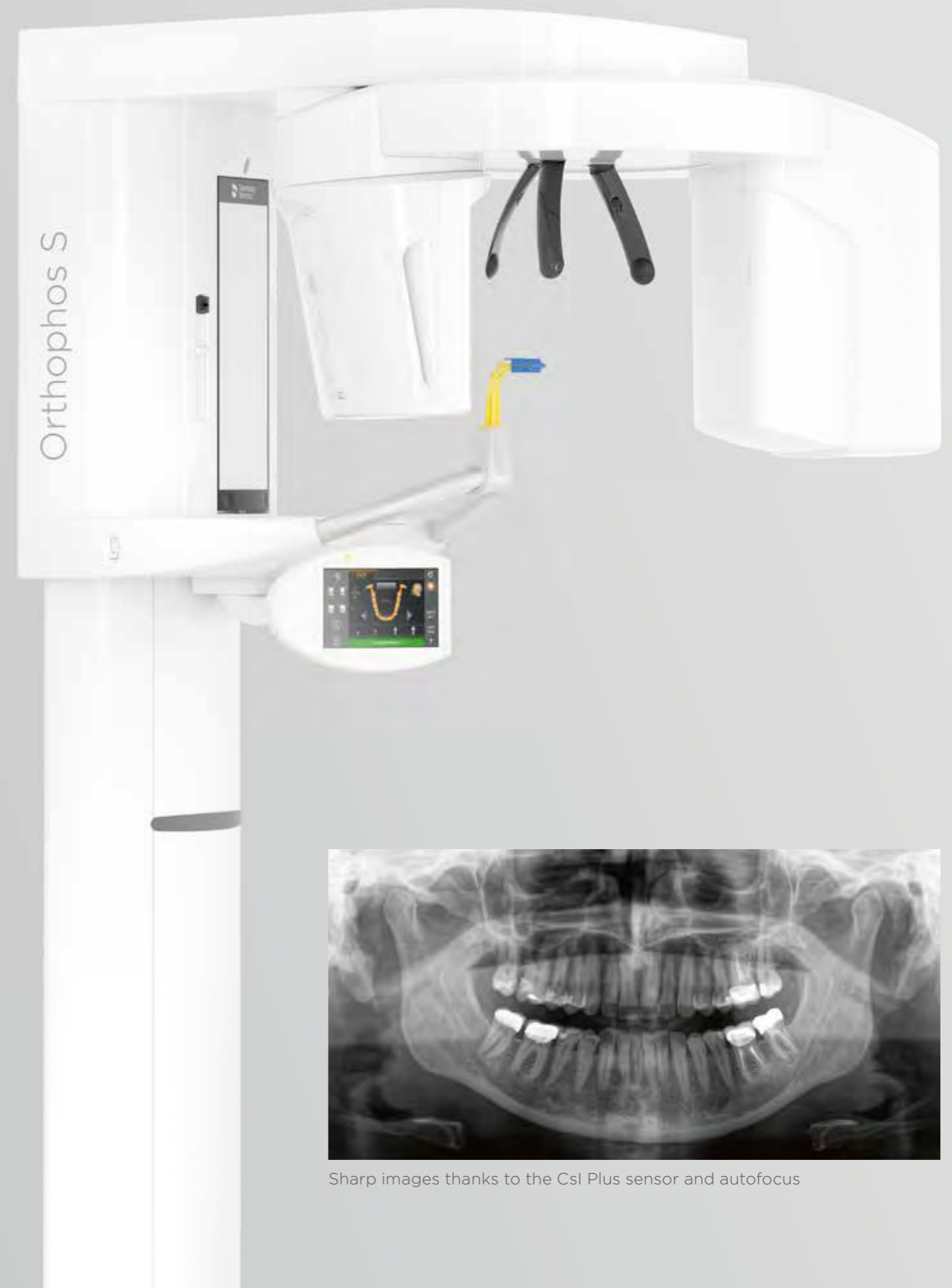

Sharp images thanks to the CSI Plus sensor and autofocus



EXTRAORAL IMAGING / 2D/3D IMAGING SYSTEM

Orthophos SL

The premium 2D/3D high-end unit for practices with a keen understanding of the latest technologies and for those who simply want more

The integrated Direct Conversion Sensor (DCS) completely redefines the standard of panoramic imaging – delivering unparalleled sharpness. The letters “SL” stand for Sharp Layer technology, which provides highly detailed panoramic images, even in difficult cases. The Orthophos SL guarantees maximum ease of use through automatic positioning, intuitive operation with the EasyPad and a customizable ambient light with 30 color options for an exclusive look and feel in your practice.

For those who want more

Services and Functions:

1

Unique DCS sensor

For outstanding, high-quality images

2

Sharp layer technology

For presentation in detailed sharpness, and the possibility for subsequent object focusing

3

Low Dose and HD function

3D imaging in the dose range of a 2D X-ray, HD images with up to 80 µm resolution

4

Autopositioning with the occlusal bite block and EasyPad

For consistent panoramic imaging results without the need of the Frankfurt Horizontal for positioning guidance

5

Comprehensive panoramic and cephalometric programs

For bitewing, sinus or ceph images, left or right ceph arms are optional and can be retrofitted at any time

6

Safe and proven patient positioning

With motorized temple and forehead supports, automatic temple width measurement, light localizers and sturdy handles

7

Coordinated volume sizes

From Ø 5 cm x 5.5 cm to Ø 11 cm x 10 cm

8

Ambient Light

Over 30 color options for a pleasant atmosphere

Orthophos SL

6467042	Orthophos SL 2D	6464973	Orthophos SL 3D 8x8 DCS
6464957	Orthophos SL 2D	6464999	Orthophos SL 3D 11x10 DCS
6473123	Ceph arm left, complete	6473123	Ceph arm left, complete
6473438	Ceph arm right, complete	6473438	Ceph arm right, complete
6466580	Orthophos SL 3D		



reddot award 2016
winner



Outstanding image quality thanks to the DCS sensor and Sharp Layer technology.



Which Orthophos is best for you?

Frequency and method of application, specialization, price and personal preferences – every dental practice has different requirements when it comes to choosing an X-ray unit. Here is a quick overview of the new Orthophos family.

Orthophos E



The preferred entry-level unit for a smooth entrance into the world of digital imaging.

Unit variants
Orthophos E 2D
Optional Ceph, left

Patient positioning
Manual

Panoramic technology
Csl sensor

Orthophos S



The reliable all-rounder with a comprehensive performance spectrum in 2D and 3D – optimized for everyday tasks in the field.

Unit variants
Orthophos S 2D
Orthophos S 3D
Optional Ceph, left or right
3D-FoV Ø 5x5.5-Ø 11x10

Patient positioning
Automatic

Panoramic technology
Csl Plus sensor
Autofocus

+ Autofocus
+ Occlusal bite block

Orthophos SL



The high-end model with the best image quality for practices with a grasp of the latest technologies – and for those who simply want more.

Unit variants
Orthophos SL 2D
Orthophos SL 3D
Optional Ceph, left or right
3D-FoV Ø 5x5.5-Ø 11x10

Patient positioning
Automatic

Panoramic technology
DCS sensor
Autofocus

+ DCS
+ Ambient Light

2D

2D/3D

Axeos. Experience the best of 3D and 2D – in one device

With Axeos, a new generation of imaging solutions has arrived.

We understand that building a successful practice requires more than just the state-of-the-art technology. We believe progress comes from technology and people – working together seamlessly. To make a difference.

It's a difference to be felt not at some distant point in the future, but today, and every day that follows it. And you won't feel this difference on your own, in a small X-ray room, but connected both to your entire practice and all of your devices. For the confidence and motivation of your whole team. For a better patient experience, and a big smile.

The next generation of progressive imaging is here. It's time for you to move on, and grow your practice. It's time to experience the difference. Start now. With Axeos.

Features which bring our values to life

Clinical Confidence:

High quality and sustainable solutions designed to provide exceptional images to support greater reliability, when diagnosing, treatment precision and clinical safety.

- **Fields of View Ø5x5.5 to Ø17x13**
more possibilities for the practice
- **DCS – Direct Conversion Sensor**
sharpness for fine 2D details
- **Intelligent Low Dose**
3D imaging in a 2D dose range
- **High Definition Mode**
with a resolution of up to 80 µm
- **Optional right or left cephalometric arm**
can be retrofitted at any time.



Smart Connectivity:

Smoothly integrated workflows, thanks to state-of-the-art digitalization, numerous planning applications and seamless workflow automation.

- **Sidexis 4 Software**
smartly connected and offers a broad array of treatment opportunities.
- **Integration into clinic and DSO networks**
through connectivity to PACS, RIS, DICOM Worklist and DICOM Printers. X-ray images according to the DICOM standard.
- **Open interfaces**
Sidexis 4 is compatible with over 200 practice management software packages. The possibility to import DICOM, STL and CEREC data or export DICOM data allows for high flexibility.

6728930	Axeos
6732999	Ceph arm left, complete
6732981	Ceph arm right, complete
6726694	Remote control with indication of the exposure parameters (incl. 15 m connection cable)
5954891	Baseplate
6368034	Extended 5-year generator/sensor warranty 3D (One-year statutory warranty, plus 4-year component warranty)

Retrofits for Axeos

6758481	Ceph retrofit, left
6758531	Ceph retrofit, right

Exceptional Experience:

Individual, innovative design and ease of use support the practice team to work more efficiently, to reduce sources of error and provide a comfortable patient experience.

- **EasyPad**
intuitive use with self-explaining symbols
- **PIA – Patient Positioning & Image Assistant**
smart height adjustment reduces waiting time for patients and unique auto-positioner for reproducible image quality
- **Integrated Cabinet**
with Ambient Light for accessory storage



EXTRAORAL IMAGING / X-RAY UNIT ACCESSORIES

Accessories for X-Ray Units

Accessories for the Orthophos SL and Orthophos XG

6094242	Universal Bite Segment (1 per pack)
6141449	Replacement Foam Parts (100 per pack)
6484989	Forehead/Temple Support (1 per pack)
6485010	Contact Buttons for Forehead/Temple Support
8921843	Bite Block Yellow (5 per pack)
8921850	Bite Block Blue (5 per pack) for Sinus Exposures
8931552	Contact Segment Blue (5 per pack) for Sinus Exposures
8931545	Contact Support Yellow (5 per pack)
5981472	Chin Rest, Complete
6485002	TMJ Support (right)
6484997	TMJ Support (left)
1888838	Ear Olives for TMJ Support (10 per pack)
5990648	Contact Pads for TMJ Supports (10 per pack)
6490895	Contrast Element SL
6299759	Template Holder
6349109	X-Ray Cabinet (Kappler MED+ORG)

Accessories for Orthophos

6094242	Universal Bite Segment (1 per pack)
6141449	Replacement Foam Parts (100 per pack)
5980383	Forehead/Temple Support (1 per pack)
5980391	Contact Buttons for Forehead/Temple Support
8921843	Bite Block Yellow (5 per pack)
8921850	Bite Block Blue (5 per pack) for Sinus Exposures
8931552	Contact Segment Blue (5 per pack) for Sinus Exposures
8931545	Contact Support Yellow (5 per pack)
5981472	Chin Rest, Complete
5980599	TMJ Support (right)
5980607	TMJ Support (left)
1888838	Ear Olives for TMJ Support (10 per pack)
5990648	Contact Pads for TMJ Supports (10 per pack)
5991844	Contrast Element XG
6349109	X-Ray Cabinet (Kappler MED+ORG)

Options for 2D and 3D panoramic X-ray Units

6346386	Csl Sensor Pan with ASTRA (additional by ordering)
6346394	Csl Sensor Pan/Ceph with ASTRA (additional by ordering)

5973750	Ceph-Ready (Standard sensor Pan/Ceph)
6372960	Ceph-Ready Csl (Csl Sensor Pan/Ceph with ASTRA)

Provision of a Second Sensor

6385657	Additional Csl Sensor Pan with ASTRA (pure white)
6385640	Additional Csl Sensor Pan/Ceph with ASTRA (pure white)
5936260	Additional Standard Sensor Pan (pure white)
5936278	Additional Standard Sensor Pan/Ceph (pure white)
5952507	Remote Control XG with Indication of the Exposure Parameters (incl. 15m Connection Cable)
5954891	Baseplate
6306810	Extended 5-year Generator/Sensor Warranty 3D (One-Year Statutory Warranty, plus 4-year Component Warranty)
6316710	RCU XG 3D Reconstruction PC

Retrofits for Orthophos 2D and 3D-X-Ray Panoramic Unit

Retrofit (pure white)

6544527	Ceph retrofit, left
6544535	Ceph retrofit, right
6716018	3D module 11x10 for Orthophos S 3D 8x8
6546589	3D module 11x10 for Orthophos SL 3D 8x8 DCS
6593359	3D module 8x8 for Orthophos SL 2D DCS
6593367	3D module 11x10 for Orthophos SL 2D DCS

Hygienic Protective Sleeves For:

3314080	Bite Block/Contact Support (500 per pack)
5968263	Orthophos Forehead Support 150x47 (500 per pack)
3314072	Bite Block in Connection with Chin Rest (500 per pack)
5932603	Chin Rest Side/Base Piece (100 per pack)
5968255	Orthophos Handles 230x110 (100 per pack)
3314106	Nose Supports (100 per pack)
8932261	Ear Olives (20 per pack)

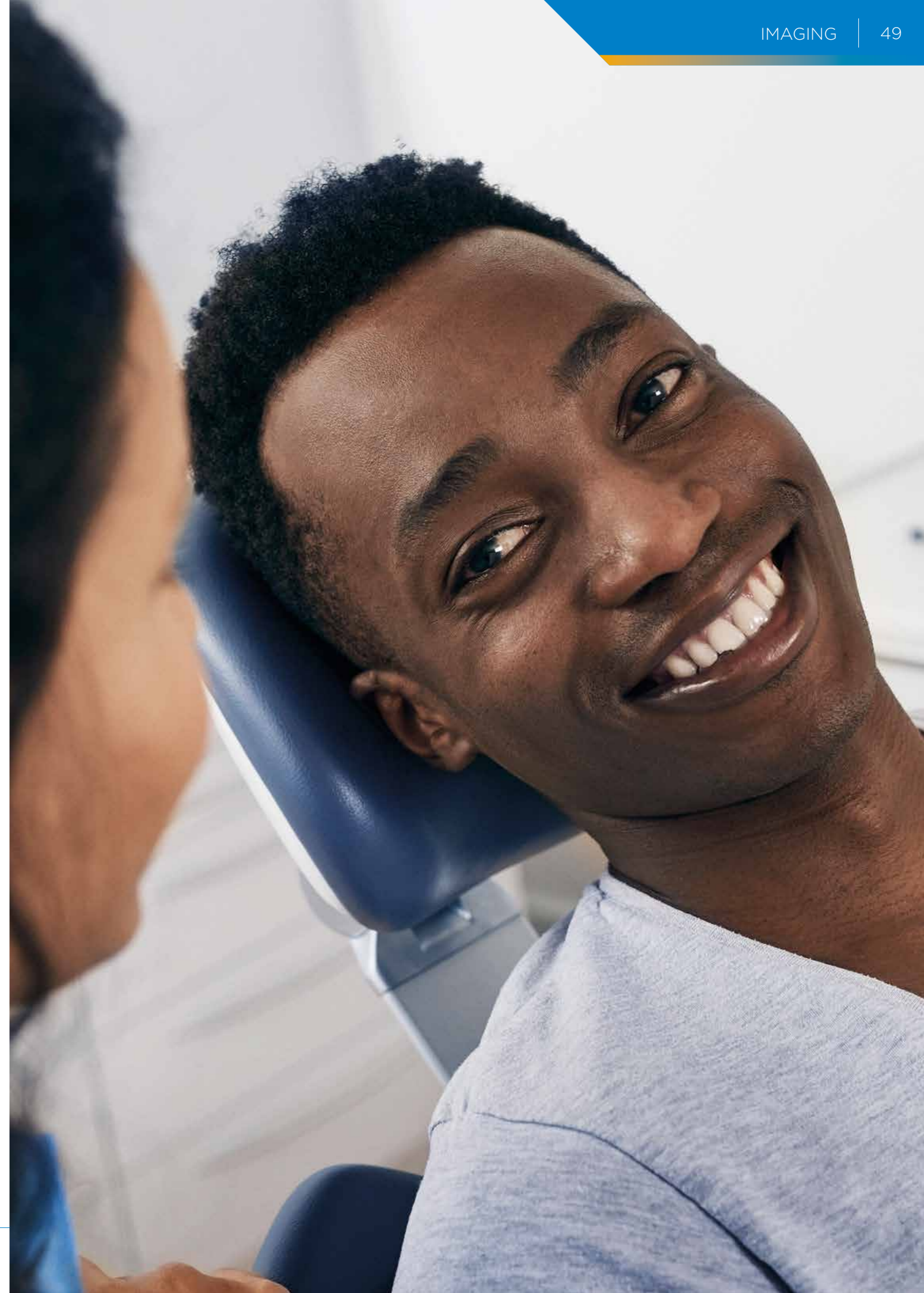

Xios Sensors

Deliver superior care with Xios sensors

Xios Sensors provides industry-leading image quality. That kind of superior image quality alone can make substantial improvements to diagnosis and patient acceptance. Backed by expansive system choices, image enhancement capabilities and a leading service and support team, Xios could very well change the way you and your patients see your entire practice.

The Xios sensors integrate seamlessly with the Dentsply Sirona X-ray units and software to deliver better, safer and faster intraoral diagnostics.



INTRAORAL IMAGING / INTRAORAL SENSOR

Xios XG Supreme

Excellent image quality and extended software tools

With 33lp/mm theoretical resolution and a CSI scintillator, the Xios XG Supreme sensor offers low-noise, optimum contrast and high-resolution X-ray images for your diagnoses within seconds. This is why it is ideal for use directly in the treatment room. Xios XG Supreme stands for modern intraoral X-rays at the highest level. With 3 sensor sizes, 3 cables lengths, and the choice between WiFi or USB connectivity, Xios XG Supreme is built on a modular design allowing you to adapt your sensors to your new needs.

Active sensor surface

- Size 0 sensor = 18 x 24mm
- Size 1 sensor = 20 x 30mm
- Size 2 sensor = 25.6 x 36mm
- Theoretical resolution: 33.3lp/mm
- Measured resolution: 28lp/mm
- Pixel size at capture: 15µm

Xios XG Kits with Sidexis

(Sidexis has not yet been installed or Sidexis XG version prior to V2.56)

Sidexis 4

6534262	Xios XG Supreme USB Size 1
6534270	Xios XG Supreme USB Size 2
6534288	Xios XG Supreme USB Size 1 and 2
6534338	Xios XG Supreme WiFi Size 1
6534346	Xios XG Supreme WiFi Size 2
6534353	Xios XG Supreme WiFi Size 1 and 2

Sidexis XG

6410794	Xios XG Supreme USB Size 1
6410802	Xios XG Supreme USB Size 2
6409556	Xios XG Supreme USB Size 1 and 2
6410810	Xios XG Supreme WiFi Size 1
6410828	Xios XG Supreme WiFi Size 2
6409564	Xios XG Supreme WiFi Size 1 and 2

"I use the Xios XG Supreme because of its mobility; I can now easily switch treatment rooms with it. The replaceable cable is also a great feature, as before I used to have issues with broken cables."

Dr. Antoine Hirardot, Le Mans, France

Xios XG Kits without Sidexis

(Sidexis XG V2.56 or higher or Sidexis 4 is already installed)

6410869	Xios XG Supreme USB Size 1
6410919	Xios XG Supreme USB Size 2
6409598	Xios XG Supreme USB Size 1 and 2
6410877	Xios XG Supreme WiFi Size 1
6410901	Xios XG Supreme WiFi Size 2
6409606	Xios XG Supreme WiFi Size 1 and 2

Conversions and extensions to existing Xios XG installations

Xios XG Supreme Sensor WiFi

6402254	Xios XG Supreme WiFi Size 0 (cable 45cm)
6402262	Xios XG Supreme WiFi Size 1 (cable 45cm)
6402270	Xios XG Supreme WiFi Size 2 (cable 45cm)

Cable Kit WiFi

6404482	Xios XG WiFi Cable Kit 45cm
6404516	Xios XG WiFi Cable Kit 90cm
6404524	Xios XG WiFi Cable Kit 180cm
6404532	Xios XG WiFi Cable Kit 270cm

Xios XG Language-Specific Set

6413434	Xios XG Language-Specific Set with Phantom and Beam Limiting Device
6413467	Xios XG Language-Specific Set with Beam Limiting Device
6411479	Xios XG Language-Specific Set International

Xios XG Supreme Sensor USB

6402221	Xios XG Supreme USB Size 0 (cable 270cm)
6402239	Xios XG Supreme USB Size 1 (cable 270cm)
6402247	Xios XG Supreme USB Size 2 (cable 270cm)

Cable Kit USB

6404169	Xios XG USB Cable Kit 90cm
6404177	Xios XG USB Cable Kit 180cm
6404185	Xios XG USB Cable Kit 270cm





INTRAORAL IMAGING / INTRAORAL SENSOR ACCESSORIES

Xios XG Sensors Accessories

Accessories

6411289	Xios XG Sensor Holder Starter Kit X-Ray Size 0/1
6411297	Xios XG Sensor Holder Starter Kit X-Ray Size 2
6545607	AimRight Sensor Holder Starter Kit S1
6545615	AimRight Sensor Holder Starter Kit S2
6404151	Xios XG Sensor Holster Kit
6404235	Xios XG USB A/B Cable (2m)

Xios XG Hygienic Covers

6409960	Hygienic Covers, Xios XG, Size 0/1 (300 per pack)
6409952	Hygienic Covers, Xios XG, Size 2 (300 per pack)

Xios XG Sensor Holder

6176528	Xios XG Posterior Sensor Holder, yellow (100 per pack)
6176510	Xios XG Anterior Sensor Holder, blue (100 per pack)
6176536	Xios XG Bitewing Sensor Holder, red (100 per pack)
6176544	Xios XG Endo Universal Sensor Holder, green (100 per pack)
6176551	Xios XG Endo Sensor Holder, grey (50 per pack) for measurement exposures
6545599	AimRight Aiming Ring, red (1 per pack)
6545557	AimRight Sensor Holder, bitewing/ red S1 (2 per pack)
6545565	AimRight Sensor Holder, bitewing/ red S2 (2 per pack)
6545573	AimRight Sensor Holder, anterior/ blue S1 (2 per pack)
6545581	AimRight Sensor Holder, anterior/ blue S2 (2 per pack)
6545532	AimRight Sensor Holder, posterior/ yellow S1 (4 per pack)
6545540	AimRight Sensor Holder, posterior/ yellow S2 (4 per pack)

The complete family

The imaging systems from Dentsply Sirona meet the highest standards in image quality and safety. Thanks to our 3D, 2D and intraoral X-rays offerings alongside premium and modern software options, you can rely on optimal results with integrated dental workflows.



INTRAORAL IMAGING / INTRAORAL SENSOR

Xios AE

NEW

Dentsply Sirona's new Advanced Exposure technology offers you the extra security you need for your diagnosis. The Xios AE sensor combines the proven resolution of 33 lp/mm* with innovative filtering functions that provide even better contrast for indications such as caries and endodontics. Low-noise images, visibility of previously underexposed or overexposed image areas and a dedicated post-exposure correction that compensates for non-optimal exposure parameter settings all help to provide relevant advantages in diagnostic certainty. Your benefits? Diagnostic clarity at first glance. Images available within seconds. Confidence in your treatment assessment. This is what Advanced Exposure stands for.

Tolerant exposure spectrum - Your independence from precise generator settings.

Dose sensitivity and subsequent data processing are of essential significance for the achieved image quality. The new Xios AE sensor is much more resistant to fluctuations in exposure parameters. Even in lower dose ranges, more details become visibly evident.

Xios AE

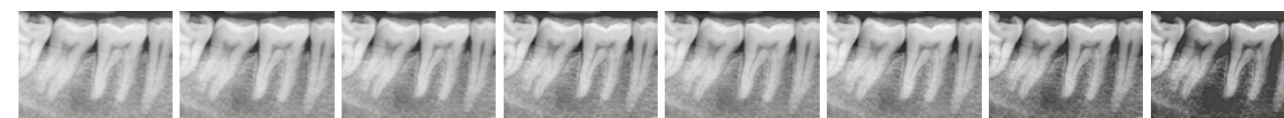

Exposure time

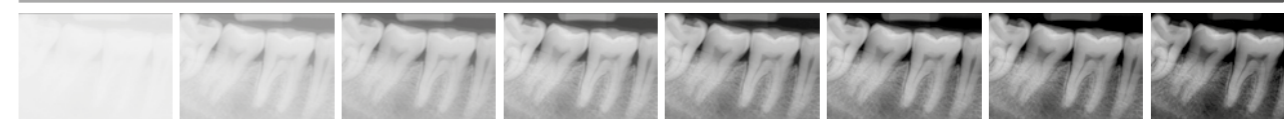

Regular sensor

Diagnostic support via software

In addition to the dynamic sharpening slider, the Xios AE provides you with four exclusive advanced filtering enhancements: General Dentistry, Endodontic, Periodontic and Restorative. Depending on the indication-based filter you select, relevant structures are highlighted accordingly in an individual image impression. With just a simple click of your mouse, you can choose which mode will best support the specific clinical situation.

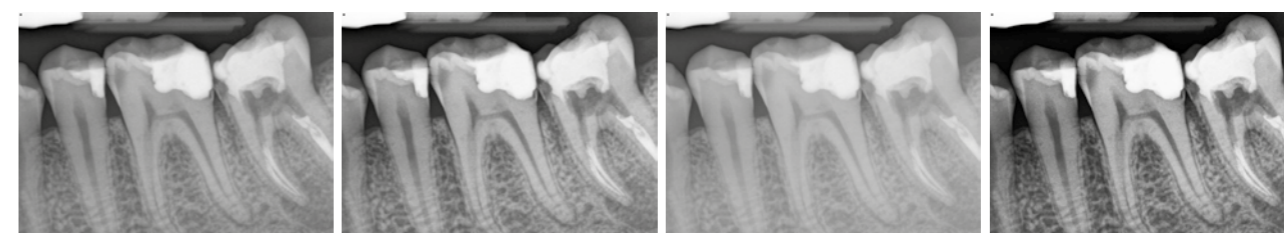

General Dentistry

Endodontic

Periodontic

Restorative

* Theoretical resolution

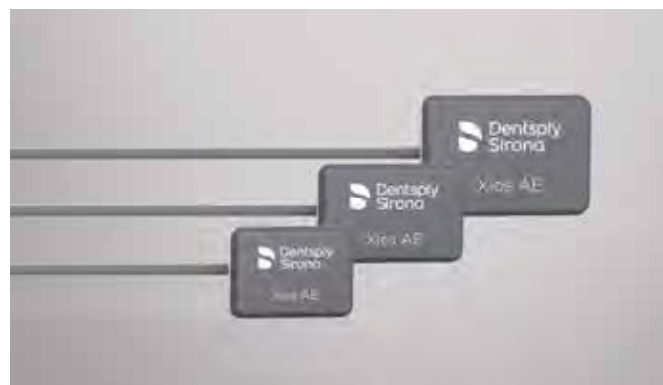

Sensor sizes

- Size 2:** Adult bitewings and single tooth images
Size 1: Single tooth images for smaller adults and bite wings for larger children
Size 0: Pediatric images



Easy cable exchange

In the event that a cable gets damaged, you have the ability to change it out completely in-house and within minutes. Only two screws need to be loosened to replace your cable and protect your investment, guaranteeing no lost productivity.

Technical Data

Xios AE in combination with Sidexis version 4.3 (and higher)

Sensors

Active area - Size 0	18 mm x 24 mm
Sensor dimensions - Size 0	23.6 mm x 32 mm x 7.5 mm
Active area - Size 1	20 mm x 30 mm
Sensor dimensions - Size 1	25.4 mm x 38.3 mm x 7.5 mm
Active area - Size 2	25.6 mm x 36 mm
Sensor dimensions - Size 2	31.2 mm x 43 mm x 7.5 mm
Physical pixel size	15 mm



USB 3 - Secure data transfer

The use of Xios AE sensors in combination with the new USB 3 interface allows for accelerated information read-out and optimized data transfer. Protected connection plugs provide additional durability in daily practice use.



Your benefits with Xios AE

- High dynamic range
- Outstanding image quality for a safe and reliable diagnosis
- Exclusive Advanced Exposure filters and dynamic sharpening slider
- Optimized data transfer with new USB 3 module
- Proven investment security

Xios AE in combination with Sidexis version 4.3 (and higher)

Sensors

Measured resolution	28 lp/mm
Theoretical resolution	33 lp/mm
Cable length	Up to max. 2.7 m
USB Interface	
USB interface port	USB 3
Power supply	USB port





INTRAORAL IMAGING / INTRAORAL X-RAY UNIT

Heliodent Plus

The confidence needed for your daily diagnostics

Thanks to its various installation options, Heliodent Plus flexibly adapts to every X-ray situation in every room of your practice, regardless of room dimensions. Whether wall module or ceiling mount, on the treatment centre or mobile control unit installation, you choose the X-ray module that offers optimum workflow.

The Heliodent Plus features a multi-colour display and is designed for film-based and digital imaging. The patient-specific exposure time is selected by pressing the patient and tooth icons. The robust, vibration-dampened support arm allows the exposure to be triggered immediately.

Benefits at a glance:

- Safe and intuitive operation
- Flexibility thanks to the three support arm lengths
- Can also be operated outside the X-ray room thanks to the remote function
- Robust quality ensures durability

"Now that we have installed the new X-ray unit, operating errors are a thing of the past. It is very nice having the option of taking either analog or digital X-rays. The tube head holds very steady so there are no more blurred images."

Dr. Arnolds, Mönchengladbach, Germany



Heliodent Plus Wall Version

- 6483734 Wall-Mounted Model (round support arm system) - 2040mm (XL) / 1790mm (L) / 1500mm (M)
- 6483726 Wall-Mounted Model (square support arm system) - 2040mm (XL) / 1790mm (L) / 1500mm (M)

Mobile Cart for Heliodent Plus

- 6452259 Mobile Cart for Heliodent Plus

Unit model Heliodent Plus

- 6489624 Heliodent Plus Unit Model on the Treatment Centre



Available in 4 different variations, to adapt to your practice's space and style.

Ceiling Model Heliodent Plus

- 6602234 Ceiling Model Heliodent Plus (wall Module with user interface, manual exposure release, square support arm system and X-ray unit)
- 6445204 For Configuration as a Ceiling Combination with LEDview Plus (the ceiling model - LEDview Plus for the ceiling combination with adaptor for Heliodent Plus must be ordered separately)
- 6445196 Ceiling Mount with Mounting Tube and Lamp Crown (for ceiling heights from 2.5 - 3.4m or for ceiling heights up to 2.5m)
- 6571272 Ceiling Model LEDview Plus (Specified just as LEDview Plus unit model, includes additionally an integrated touch panel to control all functions independently from the treatment centre)
- 6445162 Adaptation for Heliodent Plus Ceiling Model

Try me with...

LEDview Plus

The LEDview Plus operating light is available as a ceiling combination with Heliodent Plus that not only creates optimal viewing conditions but also enables you to take intraoral images directly on your treatment unit.



Options (packaged with the unit)

- 6281930 Manual Exposure Release
- 6196070 Remote Control
- 6200542 Remote Timer
- 6233022 Heliodent Plus Round Tube Prolongation to 30cm (12")
- 6233030 Heliodent Plus Rectangular Tube Prolongation to 30cm (12")
- 5969779 Phantom for Constancy Test

Options (packaged and delivered separately)

- 6256486 Manual Exposure Release
- 6256452 Remote Control
- 6256445 Remote Timer
- 6241983 Heliodent Plus Round Tube Prolongation to 30cm (12")
- 6241975 Heliodent Plus Rectangular Tube Prolongation to 30 cm (12")
- 5969779 Phantom for Constancy Test

Accessories and Spare Parts

- 6242254 Adapter Plate for Heliodent Plus
- 6242007 Beam Limiting Device 2x3cm
- 6241991 Beam Limiting Device 3x4cm





IMAGING SOFTWARE / IMAGING PROCESSING SOFTWARE

Sidexis 4

Optimum workflow with a clear structure

Sidexis 4 is the software for clear diagnoses. It efficiently structures your workflow in its modern and intuitive design and serves as a basis for further planning and diagnosis. This means you have everything you need at a glance. With Sidexis 4, you can apply the advantages of integrated dental workflows for optimal results. The X-ray software saves time, is safe, and improves your results. At the same time, its award-winning, modern user interface makes it incredibly easy to operate.

Sidexis 4 provides a number of important functions for patient acquisition, image management, analysis, diagnosis, patient communication and a simple transfer of images.

"The switch to Sidexis 4 was a quantum leap. It feels like switching from MS-DOS to Windows."

Dr. Ulrich Fürst, Attnang-Puchheim, Austria



Sidexis 4 Compare function



Sidexis 4 Lightbox function



Sidexis 4 has the following features

- Light Box, Timeline and Compare Functions
- Filter and image processing for improving the evaluation process and patient communication (automatic, individually configured filters can be set up to save even more time)
- Measurement and annotation tools
- Workflow integration for images from Dentsply Sirona units (X-ray units, treatment centers, intraoral video cameras, CEREC, SICAT Air and SICAT Function) and some third-party units
- Imaging templates for efficient intraoral status imaging
- Quick and intuitive import
- Directory monitoring: Sidexis 4 monitors a directory in the network for you and imports the data from this directory. Integrating your DSLR camera with Sidexis 4 is especially simple
- Export in a variety of formats, e.g. DICOM and PDF or as Viewer - quick and easy to generate
- Galileos Implant add-on for integrated implantology is available
- Interface for the integration of additional software applications, e.g. patient management



Sidexis 4

6618248	Sidexis 4 Full Version
6618255	Sidexis 4 Upgrade (Upgrade of an existing Sidexis XG version to the current Sidexis 4 version. Requires an existing Sidexis XG license. Please note that the installation requirements differ from those of Sidexis XG)
6618263	Sidexis 4 Update (Update of a Sidexis 4 license to the current Sidexis 4 version. Sidexis 4 must already be installed on the PC which is to be updated)

Sidexis extensions

6201136	Sidicom WLS Full Version Sidicom DICOM Work List Storage is a plug-in for Sidexis and supports the following DICOM services: <ul style="list-style-type: none"> • Modality Worklist SCU • C-Store SCU • Modality Performed Procedure Step (MPPS) (Requirement: Sidexis 4, Version 4.1.2 or higher or Sidexis XG, Version 2.6.1 or higher)
6594969	Sidicom WLS Update Update of a Sidicom WLS license to the latest version of Sidicom WLS. Requires an existing Sidicom WLS installation on a computer to be updated (Requirement: Sidexis 4, Version 4.1.2 or higher or Sidexis XG, Version 2.6.1 or higher)
5937144	Sidicom PS Full Version Enables the direct output of Sidexis XG data on DICOM printers (Requirement: Sidexis 4, Version 4.1.2 or higher or Sidexis XG, Version 2.6.1 or higher)
6256874	Sidicom PS Upgrade Upgrades the DICOM Print Interface to the currently valid version of Sidicom PS. An existing DICOM Print license is required



IMAGING SOFTWARE / INTEGRATED IMPLANTOLOGY

SICAT Implant

Implant planning for your Dentsply Sirona CBCT X-ray unit

Even if you are just getting started in implantology or place implants infrequently, SICAT Implant will lead you through the implant planning process efficiently and within minutes for absolute safety. Thanks to colour visualisation of the nerve canal and the depiction of the bones in all dimensions, the implant can be ideally adapted to fit the patient's anatomy.

This ensures high confidence, since stress is minimised through precise planning and implementation. Implantation is not only safer, thanks to directly visible surgical conditions, but also minimally invasive. What's more, you will also save time during patient consultations since your patients understand the 3D visualisation more easily.

"Guided processes are the future of implantology. They ensure greater precision and enhanced safety, especially in difficult situations."

**Dr. Gerhard Werling, General dentist,
Bellheim, Germany**

SICAT Implant

SICAT Implant comes with all Dentsply Sirona 3D X-ray units, see pages 36-41.

Try me with...

Orthophos SL and CEREC

Plan your implant treatment easily and effectively in the SICAT Implant software thanks to high-quality and razor-sharp X-ray images with the Orthophos SL X-ray unit and accurate digital impressions with the CEREC Primescan and CEREC Omnicam. Then mill your restorations directly in your practice with the CEREC milling and grinding unit. A 100% digital workflow solution from Dentsply Sirona!



NEW:
To allow greater flexibility, SICAT Implant software is now open for the import of third-party intraoral surface scan data.



IMAGING SOFTWARE / SLEEP APNEA TREATMENT

SICAT Air

The first 3D solution for obstructive sleep apnea (OSA) therapy

SICAT Air is the first 3D solution to allow not only the analysis of the upper airway, but also visualisation and planning of the appliance-based treatment true to anatomy. The combination of the patient's 3D X-ray and optical surface data allow for a completely digital workflow.

Analysis, treatment planning and the order of a SICAT Optisleep appliance can be done in one single patient session.

SICAT Air

6582956
SICAT Air includes the SICAT Suite (software for managing new SICAT applications) and the license voucher to activate the SICAT Air software

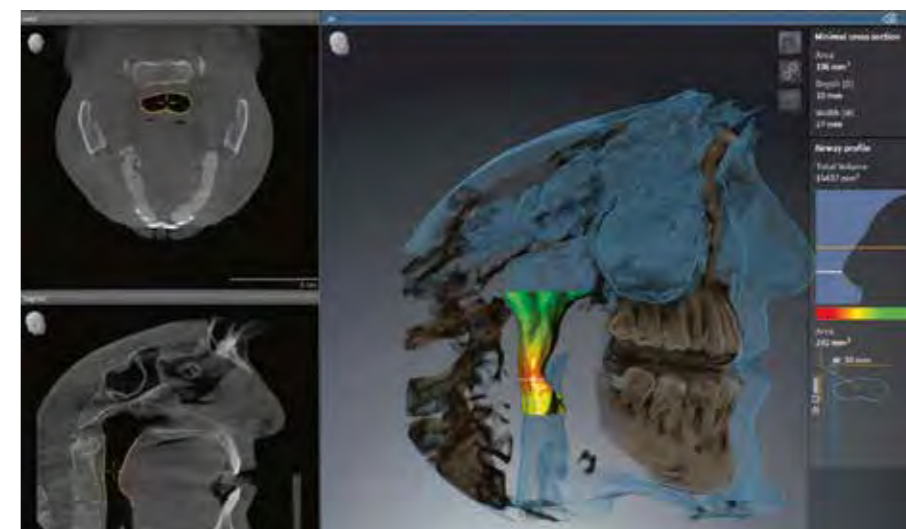

IMAGING SOFTWARE / TMJD TREATMENT

SICAT Function

Track real motion in motion

SICAT Function is the first integrated digital 3D solution to visualise real patient-individual movement of the lower jaw within the 3D volume. The anatomic traces of the temporomandibular joint can be displayed for every possible position in the volume.

- Direct visualisation of anatomically correct jaw movement, incl. real Condyle-Fossa relationship
- Diagnosis, planning and consultation with your patient - all in one chairside session
- Integration with CEREC for a 100% digital workflow
- High patient acceptance

SICAT Function

6470038 SICAT Function Starter Kit
The starter kit consists of the SICAT Suite (software for the management of new SICAT applications) and the SICAT JMT+ hardware.

6455641 SICAT Function
Software for visualization, diagnosis and therapy planning in connection with craniomandibular dysfunctions

6455674 SICAT JMT+
JMT+ (JMT = Jaw Motion Tracker) hardware for the recording of the jaw movements





IMAGING SOFTWARE / INTEGRATED IMPLANTOLOGY

SICAT Endo

The first dedicated guided endo solution

SICAT Endo is the first and only 3D solution for the diagnosis and planning of endodontic treatments. In addition to providing a more detailed realization of guided root canal treatment, SICAT Endo simplifies the endodontic process as a whole, providing security and peace of mind.

- Easy identification of all canals in 3D
- Integrated optical impressions provide a precise visualization of occlusal reference points
- Determine the exact working length and depth of cavity access including outstanding 360 view

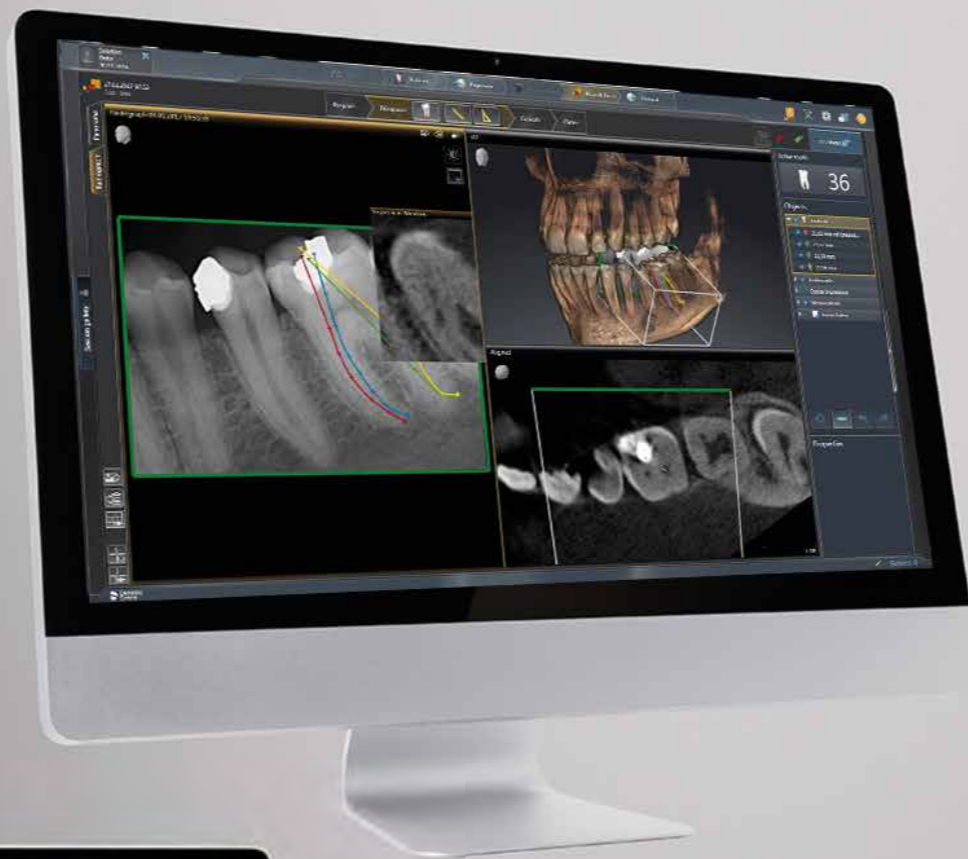

SICAT Endo

6622471 SICAT Endo includes the SICAT Suite (software for managing new SICAT applications) and the license voucher to activate the SICAT Endo software.





IMAGING CONSUMABLES / RADIOGRAPHY HOLDERS - DISPOSABLE

Uni-Grip®

Produces a full mouth series using only one holder for faster FMX

- Make your FMX go faster - one disposable holder for a complete full mouth series
- Rotates 360° for posteriors, anteriors and bitewings
- More positioning range - 70% more posterior and 25% more anterior* to help capture the anatomy you want to see
- 20% thinner base means less bulk for smaller mouths*
- Works with any size 1 and size 2 sensors and all film/PSP imaging plates
- Perforated adhesive tabs for fast, easy removal



Uni-Grip® 360 Universal Digital Sensor Holder

- 550052 Uni-Grip® 360 Kit
(50x Uni-Grip 360 Universal Sensor Holders, 50x Sensor Covers)
- 550252 Uni-Grip® 360 Combo Pack
(100x Uni-Grip® 360 Universal Sensor Holders, 100x Sensor Covers, 1x Uni-GripAR® Positioning Arm & Ring)

Uni-Grip® Holders for Film & PSP

- 550055 Uni-Grip® Kit for Film and Phosphor Plates
(50 per pack)
- 550255 Uni-Grip® Combo Kit for Film and Phosphor Plates
(2x 550055 Kits and 1x Uni-GripAR® Positioning Arm & Ring)

Try me with...

Uni-GripAR®
Positioning Arm & Ring

(see below).



IMAGING CONSUMABLES / RADIOGRAPHY HOLDERS - DISPOSABLE

Uni-GripAR® Positioning Arm & Ring

Accurately align your X-ray cone for Uni-Grip® holders

The Uni-GripAR® Positioning Arm & Ring works with Uni-Grip® and Uni-Grip® 360 to accurately align your X-ray cone for precise X-rays.

- Colour coded for quick assembly for any position
- Works with Uni-Grip® 360 universal disposable sensor holder for digital sensors and Uni-Grip® holders for film/PSP imaging plates
- Lightweight for patient comfort
- Autoclavable

550100 Uni-GripAR® Positioning Arm & Ring



*As compared to original Uni-Grip®



IMAGING CONSUMABLES / RADIOGRAPHY HOLDERS - AUTOCLAVABLE

XCP-DS Fit® Universal Digital Sensor Holders

Stretches to fit any size and any brand

Reduce loading time during your digital radiograph procedures with the XCP-DS Fit® universal autoclavable sensor holder.

- Universal design provides a custom fit to your sensor
- One holder works with both size 1 and size 2 sensors for less inventory
- Autoclavable for lower cost per use
- Rigid sensor support keeps sensor positioned accurately
- Silicone-cushioned edges help provide patient comfort and prevent sensor cover perforations



Try me with...

Xios XG Supreme
Sensor

For low-noise, optimum contrast and high-resolution X-ray images for your diagnoses within seconds.



XCP-DS Fit® Universal Digital Sensor Holders Kits

- 559900 XCP-DS Fit® Hygiene Kit with XCP-ORA® (1x XCP-ORA® Arm and Ring, 8x XCP-DS Fit® Biteblocks 2x each: anterior, posterior, horizontal bitewing, vertical bitewing), 50x Universal Sensor Covers)
- 559908 XCP-DS Fit® Endo Kit (1x Endo Ring, 1x Endo Arm, 2x XCP-DS Fit® Endo Biteblocks)
- 559909 XCP-DS Fit® Complete Kit with XCP-ORA® (XCP-ORA® Arm and Ring, Endo Arm And Ring, 10x XCP-DS Fit® Biteblocks (2 each: anterior, posterior, horizontal bitewing, vertical bitewing, endo), 50x Universal Sensor Covers)

XCP-DS Fit® Biteblock Refill Packs (2 per pack)

- 559901 Anterior
- 559902 Posterior
- 559903 Horizontal Bitewing
- 559904 Vertical Bitewing
- 559905 Endodontic Bitewing

XCP-DS Fit® Replacement Silicone Bands (6 bands per pack)

- 559913 Short (for Posterior, VBW, Endo, and Size 0)
- 559914 Long (for Anterior, Anterior-Thin, and HBW)



IMAGING CONSUMABLES / RADIOGRAPHY HOLDERS - AUTOCLAVABLE

XCP® Extension Cone Paralleling System

Your key to accurate positioning

With XCP® Extension Cone Paralleling Arms and Rings you can achieve distortion-free radiographs. XCP® Arms and Rings work with XCP-DS® Digital Biteblocks.

- Works with film, PSP and digital sensors
- Quickly align the X-ray tube to media
- Accurate positioning and precise X-rays prevent cone cutting
- Easy to assemble with colour coded XCP® components
- Patented colour coding: Anterior-Blue, Posterior-Yellow, Red-Bitewing
- The ergonomic design along with the light weight and compact design enhance patient comfort
- Autoclavable for low cost per use

XCP® Extension Cone Paralleling System for Digital Sensors

XCP® Replacement Stainless Steel Indicator Arms

540857	Anterior Arm (blue pins)
540858	Posterior Arm (yellow pins)
540927	Bitewing Arm (red pins)
550597	Endo Arm (no pins)



XCP® Replacement Anterior Aiming Rings

540865	Anterior Ring (blue)
540860	Posterior Ring (yellow)
540934	Bitewing Ring (red)
550598	Endo Ring (green)



XCP® Extension Cone Paralleling System for Film and PSP

XCP® Evolution 2000 Instrument Kits with Film/PSP Biteblocks

542001	XCP® Kit with Bitewing Instrument (4x Arms & Rings: 1x Ant., 2x Post., 1x BW 17x Biteblocks: 4x Ant., 8x Post., 5 BW (2x H2, 1x V2, 1x H 0/1, 1x V1); instructional poster)
542003	XCP® Kit with Bitewing and Endodontic (Includes all the contents of 542001, and 1x Endo Arm & Ring and 4x Endo Biteblocks)
542045	XCP® Endodontic Kit for Film/PSP (1x Endo Arm & Ring, 3x Endo Biteblocks)



XCP® Colour-Coded Biteblocks

540861	Anterior (Blue) (25 per pack)
540862	Posterior (Yellow) (25 per pack)



IMAGING CONSUMABLES / RADIOGRAPHY HOLDERS - AUTOCLAVABLE

XCP-ORA® One Ring & Arm Positioning System

One ring, one arm, one goal

3-in-1 positioning convenience for anterior, posterior and bitewing. The XCP-ORA® One Ring & Arm Positioning System reduces the components needed to accurately position radiographic media with XCP® or XCP-DS® biteblocks to just one ring and one arm.

The lightweight construction helps patients maintain positioning while the raised collimator ribs help stop tubehead drift. The XCP-ORA® works with film, phosphor plates and digital sensors and is autoclavable for low cost per use.

- For film and sensors
- Autoclavable for low cost-per-use
- Lightweight construction helps patients maintain positioning
- Unique ring & arm design simplifies your positioning procedure with fewer parts
- Ideal for use with rectangular collimators
- Faster and easier radiographic accuracy

550771	XCP-ORA® Arm & Ring Single Pack (1x arm, 1x ring)
550772	XCP-ORA® Arm & Ring Double Pack (2x arm, 2x ring)
542071	XCP-ORA® and Biteblock Kit for Film and PSP Kit contains: • 1x XCP-ORA® Arm & Ring • Full set of Anterior, Posterior and Bitewing Biteblocks





IMAGING CONSUMABLES / RADIOGRAPHY HOLDERS - AUTOCLAVABLE

Snap-A-Ray® DS Universal Digital Sensor Holder

Save time with the easy-to-use universal sensor holder

Our Snap-A-Ray® DS digital sensor holder allows you to quickly load and place digital sensors for accurate periapical radiographs. Prefer to use an arm and ring? You can with this new design: An optional 2-in-1 aiming ring and arm kit is available.

Save time with the easy-to-use Snap-A-Ray® DS digital sensor holder:

- Universal design fits size 1 and size 2 digital sensors
- Soft overmolding is gentle to the sensor case. Soft grips protect the sensor case from hard edges
- Rigid design prevents flexing
- Use with optional arm and ring
- Autoclavable for low cost per use
- Endo version also available

Snap-A-Ray® DS

550321 Snap-A-Ray® DS (1 per pack)
550323 Snap-A-Ray® DS (3 per pack)

Snap-A-Ray® DS Arm & Ring Kit

550322 Snap-A-Ray® DS Arm & Ring Kit
Optional arm and ring kit allows for easy alignment. (1x 2-in-1 aiming ring, 1x straight arm, 1x angled arm)

Snap-A-Ray® DS Endo

550421 Snap-A-Ray® DS Endo (1 per pack)
550423 Snap-A-Ray® DS Endo (3 per pack)



IMAGING CONSUMABLES / RADIOGRAPHY HOLDERS - AUTOCLAVABLE

Snap-A-Ray® Xtra Film & Phosphor Plate Holder

Take the guesswork out of bisecting angle radiographs

- Angled anterior bite area and backing plate
- Cushioned media grips hold film and phosphor plates securely without damaging the media
- Eliminates manual retention of film or PSP packet
- Textured bite surfaces to help maintain position
- Cushioned bite areas enhance patient comfort
- Autoclavable for low cost per use
- Fast and easy periapical imaging

Snap-A-Ray® Xtra Film & Phosphor Plate Holder

540501 Snap-A-Ray® Xtra Film & Phosphor Plate Holder (1 per pack)
540503 Snap-A-Ray® Xtra Film & Phosphor Plate Holder (3 per pack)



IMAGING CONSUMABLES / RADIOGRAPHY HOLDERS - AUTOCLAVABLE

Eezee-Grip® Universal Digital Sensor Holder

Quick and easy set up

Simply insert sensor, squeeze, and you're ready to go. Use for convenient anterior and posterior digital periapical radiographs.

- Accurate positioning for distortion-free radiographs
- For anterior and posterior periapical radiographs, including the third-molar region
- Autoclavable for low cost per use
- Fits most sensor brands
- Quick, easy set-up
- Patented flexible grips for patient comfort

550294 Eezee-Grip® Digital Sensor Holder (3 per pack)



IMAGING CONSUMABLES / RADIOGRAPHY HOLDERS - AUTOCLAVABLE

Rinn® Flip-Ray® PA - Periapical

Changes indications with just a flip

- Lightweight and economical
- Adjustable ring and media holder easily flip orientations for change quadrants fast
- One holder for horizontal and vertical periapicals
- Accommodates size 0, 1, and 2 film and PSP plates
- Autoclavable

552600 Flip-Ray® Complete Kit
2x Flip-Ray® PA (1x Adult, 1x Pedo) and 2x Flip-Ray® BW
552601 Flip-Ray® PA - Pedo (4 per pack)
552602 Flip-Ray® PA - Adult (4 per pack)



IMAGING CONSUMABLES / RADIOGRAPHY HOLDERS - AUTOCLAVABLE

Rinn® Flip-Ray® BW - Bitewing

Changes indications with just a flip

- One holder for horizontal or vertical bitewings
- Universal media clip accommodates size 0, 1, & 2 film or phosphor plates with no separate biteblocks
- Lightweight plastic construction for easy handling and patient comfort
- Autoclavable

552603 Flip-Ray® BW Universal Bitewing Holder (5 per pack)



IMAGING CONSUMABLES / RADIOGRAPHY HOLDERS - AUTOCLAVABLE

EndoRay® II Film Holder

Prevents cone-cutting with precise angulation and alignment of film and PSP imaging plates

- Fits over files, clamps and rubber dams
- Use for endodontic radiography without touching the subject tooth
- Autoclavable
- Use with size 1 or 2 film and PSP plates



540303 EndoRay® II (2 per pack)



IMAGING CONSUMABLES / DISPOSABLES FOR DIGITAL SENSORS

Rinn® Universal Disposable Digital Sensor Cover Bags

The relaxed-fit bags

- Less risk of damage to sensor cord*
- Universal bag sized to fit size 1 and size 2 loosely
- Rounded edges for comfort



550500 Rinn® Universal Digital Sensor Covers 1.5" x 7"
(500 per pack)



IMAGING CONSUMABLES / DISPOSABLES FOR FILM/PSP

Disposable XCP® Biteblock

Use with XCP® systems

The Disposable XCP® Biteblock works with the XCP® Extension Cone Paralleling Arms and Rings for distortion-free radiographs.

- For size 0, 1 and 2 film
- Break off front section for pedo application
- XCP® Arms and Rings sold separately

Can be used alone or with:

- XCP® Arms and Rings
- XCP-ORA® 3-in-1 Arm and Ring



540870 Disposable XCP® Biteblocks (100 per pack) (36 cases/case)





IMAGING CONSUMABLES / RADIATION PROTECTION

Rinn® Universal Collimator

Cut your patient radiation exposure by up to 51%*

Align the beam and prevent mis-focusing of X-rays by absorbing divergent radiation, and prevent radiation leakage.

- Protect patients by limiting the size of the primary X-ray beam to the size of a #2 film
- Quickly applies into open end of round PID
- Vertical or horizontal use
- Complies with NCRP Report 145



540853 Universal Collimator

Try me with...

XCP-ORA®,
XCP®/BAI® or
EndoRay® II
positioning systems



For accurate alignment. It can quickly be applied into the open end of a round PID, and is applicable for vertical or horizontal use. The RINN® Universal Collimator complies with the NCRP Report 145.



NEW

Xios AE

More details. Higher confidence.

The Advanced Exposure technology of the Xios AE sensor combines superior image quality with optimized data read-out and exclusive innovative filtering functions to fully maximize your diagnostic potential. Smart connectivity and seamless integration into Sidexis 4 imaging software (4.3 or higher) facilitates easy patient communication and treatment acceptance. Thanks to the dynamic sharpening slider, enhanced filtering options and a number of effective tools, your images are customized to the specific clinical situation and ready to support your diagnosis!



For more information on Xios AE please contact your local dealer, Dentsply Sirona sales representative, or visit dentsplysirona.com/intraoral.

THE DENTAL
SOLUTIONS
COMPANY™

 Dentsply
Sirona

Implant Systems

Contents

Astra Tech Implant System® EV	76
Xive®	78
Ankylos®	80





IMPLANTS / IMPLANT SYSTEMS

Astra Tech Implant System® EV

A minor change with great upsides for you

The new Astra Tech Implant System® EV is the next step in the continuous evolution of the Astra Tech Implant System®. The design philosophy of the Astra Tech Implant System® EV is based on the natural dentition utilising a site-specific, crown-down approach supported by an intuitive surgical protocol and a simple prosthetic workflow, for increased confidence and satisfaction for all members of the treatment team. The objective is to modify the implants design and its handling protocol and to deliver a more “forgiving” handling and a higher degree of simplicity.

System highlights:

- Paves the way for an outstanding better marginal bone level
- Stimulates the healing process using four interdependent features
- Ensures long-term function, aesthetics and patient satisfaction
- Versatile implant designs, including straight, conical, sloped, short, narrow and wide, using only one surgical tray.
- Flexible drilling protocol allows for preferred primary stability
- Site-specific restorative components including round and triangular options supporting soft tissue sculpturing.
- Unique interface with one-position-only placement for:
 - Self-guiding impression components that require only one hand for precise seating

The foundation of this evolutionary step remains the unique Astra Tech Implant System® BioManagement Complex®, well-documented for its long-term marginal bone maintenance and aesthetic results.



Preferred primary stability

The better engagement in the osteotomy makes it easier to reach the preferred primary stability.

MicroThread®

- Biomechanical bone stimulation
Minute threads on implant neck that offer optimal load distribution and stress values.

Conical Seal Design™

- A strong and stable fit
A conical connection that seals off the interior of the implant from the surrounding tissue, minimizing micromovements and microleakage.

Connective Contour™

- Increased soft tissue contact zone and volume
The unique contour that is created when you connect the abutment to the implant.



NEW INNOVATION

A site-specific, crown-down approach

The success of an implant treatment is defined not only by function, but also by aesthetics. The design philosophy of the Astra Tech Implant System® EV is based on the natural dentition and utilises a site-specific, crown-down approach with the desired end result in mind to help ensure a successful outcome.



3.0

3.6

4.2

4.8

5.4

Recommended implant size(s) in relation to tooth position, provided there is sufficient bone volume and space in relation to the adjacent dentition.

Surgical simplicity and flexibility

- **Versatile implant assortment**
The Astra Tech Implant System® EV consists of a unique range of OsseoSpeed® EV implants, including solutions for:
 - Limited vertical bone height
 - Narrow horizontal and wide spaces
 - Sloped ridge situations
 - One- and two-stage surgery
 - Immediate and early loading
- **Flexible drilling protocol that allows for preferred primary stability**
- **One surgical tray - Three overlay options**

Restorative ease

The Astra Tech Implant System® EV has been developed to simplify all phases of your dental implant therapies, especially the restorative phase. The wide range of restorative components will assist you in providing aesthetics and function to your patients.

- **Solutions for all restorative needs**
The Astra Tech Implant System® EV includes an extensive restorative assortment including patient-specific and a wide range of pre-fabricated abutments.
- **One system - One torque***
All final abutments are designed for one tightening torque value of 25Ncm for simplicity reasons. In addition, each abutment screw is optimally designed to ensure correct pre-load and a stable screw joint over time.
- **Unique interface with one-position-only* placement**
 - Atlantis® patient-specific CAD/CAM abutments
 - Self-guiding* impression components
 - One interface - Three indexing solutions

For more detailed information and item numbers, please contact your local Dentsply Sirona representative.



IMPLANTS / GUIDED SURGERY

Xive®

Versatility and ease

Xive® stands for progressive and innovative solutions, surgical versatility, and almost unlimited prosthetic freedom – An implant system that always strives to be one step ahead, offering you and your patients a wide variety of solutions.

Xive® is based on surgical and prosthetic site-specific requirements, according to your desired clinical approach for dental implant treatment. In support of this approach, Xive® provides:

- Excellent primary stability – Atraumatic and gentle in dense bone, stable and secure in soft bone
- An internal hex connection interface with clear and accurate positioning of the abutment with six reversible positioning options
- A versatile range of implants including narrow, wide and transgingival options
- A sophisticated range of prosthetic treatment concepts supporting temporary, and cement-, screw- and attachment-retained restorations

Design philosophy

Xive® is supported by more than 25 years of dental implant industry experience, including pioneering work and groundbreaking developments in the fields of immediate implant loading and implant surface design.

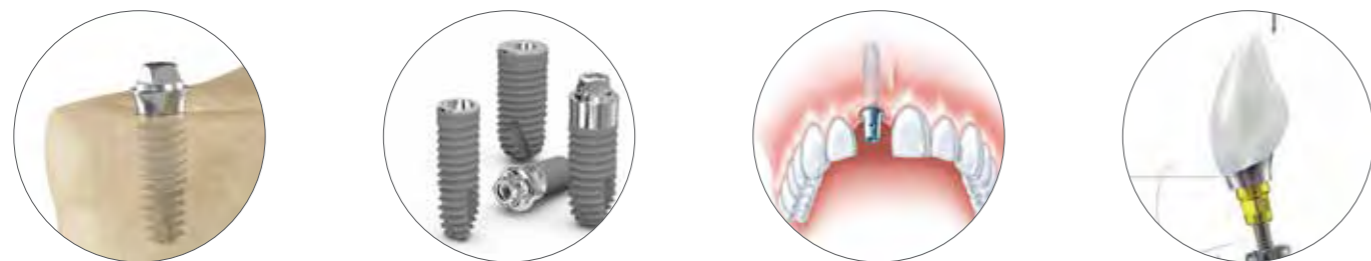

ActiveBone Control™

High primary stability in all types of bone can be achieved by the patented combination of bone-specific preparation protocol and bone-condensing thread design (friction, condensing and self-taping).

Friadent® plus surface

Grit-blasted and high temperature-etched microstructure accelerates rapid bone formation on the implant surface. This results in early osseointegration and high bone-to-implant contact.

- Outstanding wetting properties for activation of the primary cell apposition
- Unique three-dimensional microdesign
- Intensive formation of new bone
- Friadent® plus and ActiveBone Control™ are the perfect match

Bone care with platform-switch

Integrated platform switch option supports improved preservation of crestal bone levels with concurrent favourable soft tissue conditions.

- Deep internal hex connection with high precision
- Designed for effective tissue control

Easy and versatile prosthetics

A range of prefabricated and patient-specific abutments provides versatility in prosthetics, both on implant and abutment level, including immediate restorations for any possible indication; internal butt-joint connection with self-guiding properties and colour-coded or laser-marked components support error-free workflow.

- Individualised contouring of the emergence profile
- Premium and cost-effective full arch restorations

For more detailed information and item numbers, please contact your local Dentsply Sirona representative.

Surgical flexibility with Xive®

Whether you are filling the narrowest gap or an edentulous jaw, in hard or soft bone, in a single- or two-stage protocol – immediate loading or delayed loading – you always have an appropriate solution available with Xive®. The implant range of Xive® includes subgingival Xive® S and transgingival Xive® TG, in diameters from 3.0–5.5 mm and lengths from 8–18 mm. Additionally, because the endosseous portion is identical, you use the same instruments for site preparation and can determine which implant to place during the surgical procedure.

Surgical kits

Xive® features three pre-assembled modular surgical kits that can be customised with additional modules according to your clinical preferences. Clear pictograms and system-specific colour-coding ensures easy user guidance during surgery. All instruments are securely fixed in silicon holders.

- Xive® Surgical Kit D 3.0–5.5 mm / S + L - Supports the full implant assortment including Xive® TG
- Xive® Surgical Kit D 3.0–3.8 mm / S - Streamlined content for the most commonly used implants
- Xive® Surgical Kit D 3.0 mm / S + L - Minimum content only for narrow implants

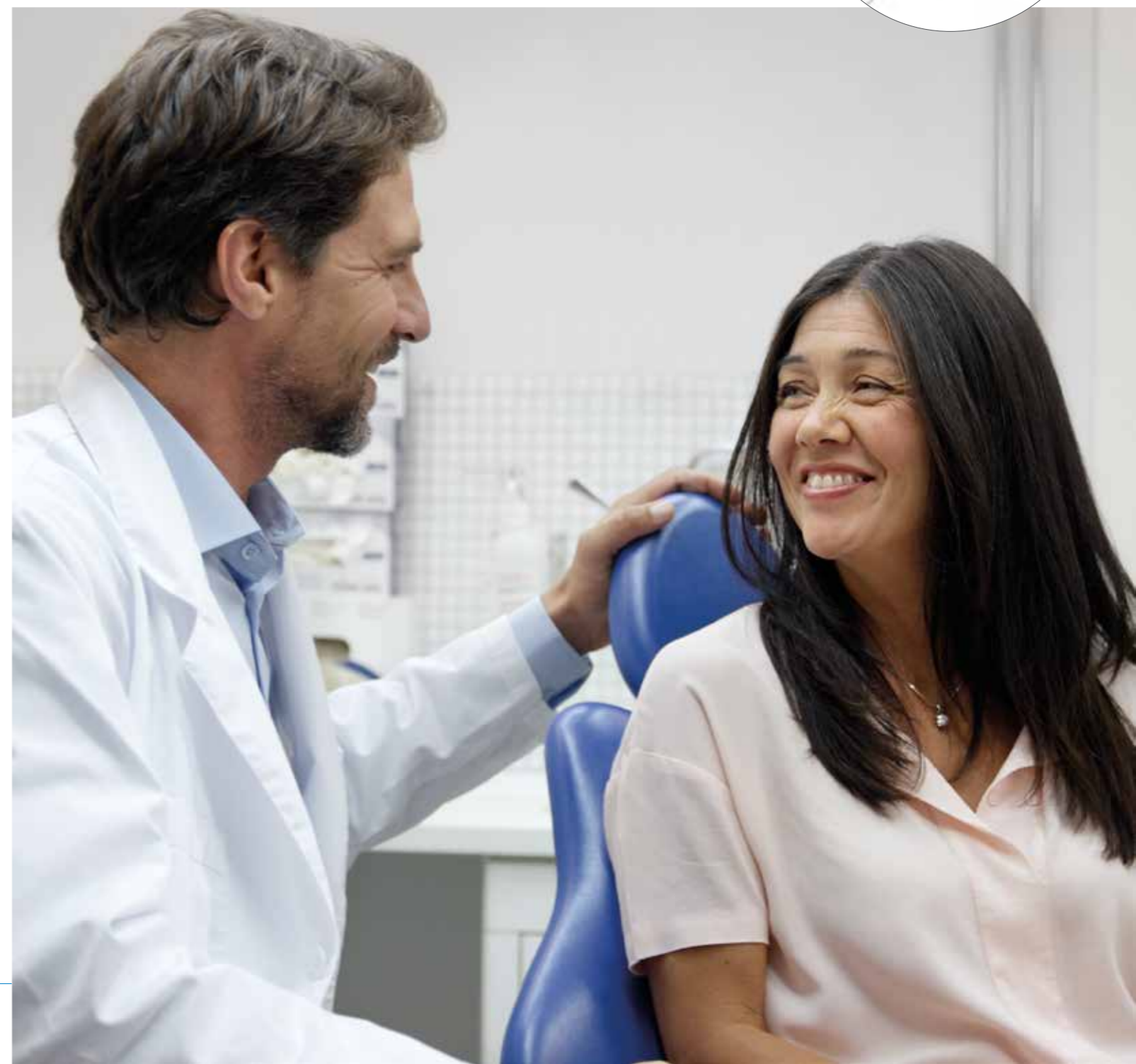



Ankylos®

Introducing the TissueCare concept

The Ankylos® implant system is a dependable and well-designed dental implant system providing you with solutions that deliver long-term stability of hard and soft tissues, lasting aesthetics and reliable functionality, which your dental patients will appreciate and Dentsply Sirona as a manufacturer backs with a lifetime warranty.

In 2017, the Ankylos® implant system celebrated its 30th anniversary. But from the beginning Ankylos® was different from all the others: Internal tapered connection, horizontal offset, and progressive thread design - revolutionary innovations in 1987.

- Predictable implant planning, considering surgical and prosthetic aspects
- Sub-millimetre range
- Automatic collision control, which displays too narrow clearances between implants or to the nerve
- Information on peri-implant bone quality for accurate conclusions on the expected primary stability
- Comprehensive 3D-communication with the patient
- Optimal team communication
- Predictable results lead to cost efficiency
- More precise implant placement with Simplant® Guide
- Immediate temporary restoration, ready prior to surgery - Immediate Smile concept
- Compatible with over 10,000 implants from more than 100 brands, as well as all DICOM compatible (CB) CT scanners and major optical and intraoral scanners
- Dental planning software with more than 20 years' experience

System highlights:

- Horizontal offset
- Subcrestal placement
- Micro-rough implant shoulder

The TissueCare concept

The Ankylos® implant system has been scientifically and clinically proven to promote and maintain hard and soft tissue over time. Called the TissueCare Concept, this combination of unique features provides you and your patients with reliable functionality and aesthetics.

One-fits-all TissueCare connection

All abutment sizes share one tapered connection simplifying the treatment protocol. A steep connection taper promotes friction lock without micro-movement, providing non-indexed prosthetics while offering an indexed option.

- TissueCare connection is identical with all implant diameters
- No correlation of implant-abutment diameter
- Focus on surgical possibilities without compromise in terms of aesthetics



SoftTissue chamber

The TissueCare connection and the micro-rough implant shoulder allow for subcrestal placement. In combination with a horizontal offset and the concave abutment design, a chamber for soft tissue and bone is created, supporting tissue stability.

- Absence of micromovement between implant and structure
- Prevention from bacterial ingrowth
- Maximises biological space through combination of narrow, concave emergence profile shape of the abutment, wide horizontal offset of abutment connection and subcrestal placement



Progressive thread

The thread design transfers the functional load to the apical part of the implant and creates primary stability allowing for immediate loading.

- The cervical geometry reduces load transfer to the cortical bone
- The continuously increasing thread depths transfer load to the cancellous bone
- Controlled loading force is achieved in the regions that are significant for the maintenance of crestal bone
- With the thread in final position, this creates primary stability allowing for immediate loading

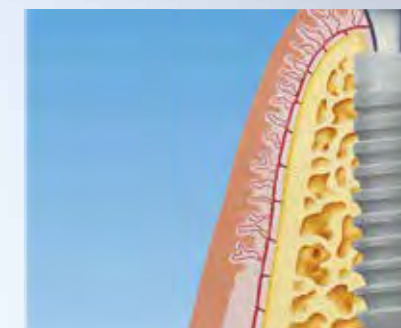

The Friadent® plus surface

The grit-blasted and high temperature-etched Friadent® plus microstructure excels by rapid bone formation on the implant surface. This results in early osseointegration and high bone-to-implant contact.

- Outstanding wetting properties for activation of the primary cell apposition
- Unique three-dimensional microdesign
- Intensive formation of new bone

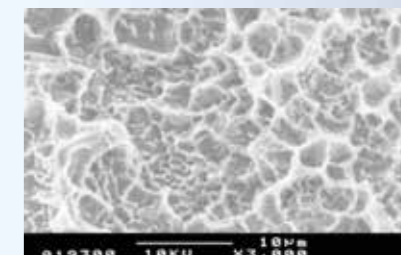

Ankylos® C/X implants

Ankylos® C/X implants are available in four diameters and six lengths. The practical size classification makes them suitable for all indications in dental implantology with a manageable number of implants. Individual implants are identified by a capital letter for diameter and a number for length (6.6-17 mm). Colour-coding is used to identify the implant diameter. Site preparation instruments are also colour-coded.

Surgical kits

Three types of surgical kits are available for Ankylos®

1. Machine-driven protocol (A and B implants only)
2. Manual insertion protocol - includes instruments for placement of Ankylos® A- and B- or A-, B- and C-implants with manual final preparation
3. Guided surgery protocol - includes instruments in 8-14 mm lengths for template-guided placement of Ankylos® C/X A- and B-implants

Prosthetic freedom

Ankylos® prosthetics are available for cement-, screw-, and attachment-retained restorations in all clinical indications. In situations when you have achieved the desired primary implant stability, and there is appropriate occlusal loading, you can opt for the immediate loading of single tooth and/or multiple tooth restorations.

For more detailed information and item numbers, please contact your local Dentsply Sirona representative.

Trust in Our Comprehensive Instrument Portfolio

Regardless of whether you cover the entire spectrum of dental treatments or only a specific field of dentistry – you can fully trust the instrument portfolio from Dentsply Sirona. Each and every quality product that we produce helps to ensure that you deliver a quality therapy in a relaxed manner, achieving outstanding results. Innovative table-top units such as our diode lasers and hygiene systems complement our flexible instrument program, and each product represents one component of our modular system for comfortable, safe and effective treatment.



Contents



Instruments

Turbines

T1 Turbines	85
T2 Turbines	86
T3 Turbines Fixed Connection and Quick Coupling	87
T4 Turbines	89



Straight and Contra-Angle Handpieces

T1 Classic	90
T1 Line	91
T2 Line	92
T3 Line	93
T4 Line	94
Implant 20:1	95
Endo 6:1	96
SiroNiTi Apex/SiroNiTi Air Plus Apex	97



Ultrasonic Scaler and Tips/ Motors and Syringes

SiroSonic L and SiroSonic TL	99
SL and SL ISO Motor	102
BL/BL E and BL ISO C/E and BL Implant Motors	103
Sprayvit	104



Table Tops

Laser

SiroLaser Blue	107
SiroLaser Advance Plus	108



Hygiene

DAC Universal S	112
DAC Premium and DAC Premium Plus	114
DAC Professional and DAC Professional Plus	115
NitraDem Direct Connect	116
SiroSeal Premium and SiroSeal Professional/Printer	117
MELAprint 44	118



Turbines

The extensive portfolio of Dentsply Sirona turbines offers dental turbines for every possible wish. All the turbines have one thing in common: complete operating control at maximum output – and with the 4-nozzle spray quieter than ever. Simply choose your favourites within the available T-Classes according to your personal preferences and method of working. Whichever turbine you prefer, Dentsply Sirona suits each individual demand. With the exclusive Click & Go interfaces, the Dentsply Sirona turbines are compatible with all the popular types of coupling. This allows you to swap turbines in seconds – at no extra cost.



INSTRUMENTS / PREMIUM CLASS TURBINES

T1 Turbines

Perfection that fits in your hand

T1 Class turbines lie ideally balanced in your hand. Regardless of whether you choose the T1 Control, T1 Boost, or T1 mini, all turbines offer high performance, give you optimal control at all times, and are extremely quiet during operation. T1 Control's patented speed control (250,000rpm) allows consistent and low-noise work, T1 Boost offers maximised performance at a whisper tone (23 watts) and T1 mini's small head (height: 12.7mm, diameter: 10.2mm) gives you the optimum access to the molar region and a perfect view of the preparation site.

T1 turbines offer these benefits:

- Ergonomic lightweight titanium sleeves
- DLC coated ceramic ball bearings*
- Control function – continuous, quiet operation
- The 4-nozzle spray makes the T1 turbines the quietest in their class
- Suitable for all common quick-coupling versions (Click & Go)
- Economical replacement of the rotor cartridge by the user
- 2 year warranty



Technical data overview:

Types	Power (w)	Head Diameter (mm)	Head Height (mm)	Weight (g)	Idling Speed (rpm)	Indication
T1 Control	Up to 22	Approx. 11.9	Approx. 13.0	Approx. 44	Approx. 250,000	Cavity preparation
T1 Boost	Up to 26	Approx. 11.4	Approx. 12.7	Approx. 44	Approx. 370,000	Cavity preparation
T1 mini	Up to 21	Approx. 9.7	Approx. 12.7	Approx. 43	Approx. 410,000	Cavity preparation

Types/Ref.	Dentsply Sirona Connection	KaVo ¹ Connection	W&H ¹ Connection	NSK ¹ Connection
T1 Control	66 89 348	66 89 363	6386770	6386812
T1 Boost	66 89 389	66 89 405	6386929	6386937
T1 mini	66 89 421	66 89 462	6387000	6387018

Dentsply Sirona quick coupling/Ref.	R, with return airflow	R (LED), with return airflow	F, without return airflow
4-hole standard interface with light, spray control and back suction stop	18 94 588	63 19 706	41 74 467

"Reliability is a priority. I only consider instruments with top-class features and excellent workmanship."

*Longer service life due to DLC (diamond-like carbon) coated ball bearings.

¹Not a registered trademark of Dentsply Sirona.



T2 Turbines

Quality you can rely on

You can rely on our T2 turbines in any situation. The continuous high performance, the ergonomic shape together with the titanium-coated exterior sleeve and the robust workmanship are guaranteed to satisfy. Similar to the T1 turbines, the T2 turbines are available as T2 Control, T2 Boost and T2 mini.

T2 turbines offer these benefits:

- Excellent grip thanks to the titanium-coated exterior sleeve
- Robust ceramic ball bearings
- Control function – continuous, quiet operation
- Low noise level: T2 turbines with 4-nozzle spray
- Suitable for all common quick-coupling versions (Click & Go)
- Economical replacement of the rotor cartridge by the user
- 2 year warranty

Technical data overview:

Types	Power (w)	Head Diameter (mm)	Head Height (mm)	Weight (g)	Idling Speed (rpm)	Indication
T2 Control	Up to 22	Approx. 11.9	Approx. 13.0	Approx. 54	Approx. 250,000	Cavity preparation
T2 Boost	Up to 26	Approx. 11.4	Approx. 12.7	Approx. 54	Approx. 370,000	Cavity preparation
T2 mini	Up to 21	Approx. 9.7	Approx. 12.7	Approx. 54	Approx. 400,000	Cavity preparation

Types/ref.	Dentsply Sirona Connection	KaVo ¹ Connection	W&H ¹ Connection	NSK ¹ Connection
T2 Control	66 89 520	66 89 546	66 89 561	66 89 603
T2 Boost	66 89 629	66 89 637	66 89 652	66 89 678
T2 mini	66 89 702	66 89 744	66 89 769	66 89 785

Dentsply Sirona quick coupling/Ref.	R, with return airflow	R (LED), with return airflow	F, without return airflow
4-hole standard interface with light, spray control and back suction stop	18 94 588	63 19 706	41 74 467

"Instruments with a high degree of functionality and ideal ergonomics are the only right choice for me."



T3 Turbines - Fixed Connection

Continued cost-effectiveness

The long-term stable materials ensure that our T3 turbines with fixed connection remain sturdy for years to come. The turbines, with a 4-nozzle spray, are especially quiet and their high-quality sleeve is simple and easy to clean.

- Very silent thanks to 4-nozzle spray
- Stainless steel, long term stable material
- Protective Head System (PHS) for a lower risk of cross-contamination
- Quick stop function (QSF) allowing for faster stop of the burr
- Clamping system with low vibrations for more precision

NEW T3 mini: With the extra small mini head options you have optimum access to the molar region and an optimal view of the preparation site. T3 mini has an impressive head size (height: 12.7mm, diameter: 10.2mm) to torque ratio.

T3 Racer: With up to 30 watts, the T3 Racer is by far the most powerful fixed connection turbine. This means that you can work even faster and even more efficiently.

Technical data overview:

Types	Power (w)	Head Diameter (mm)	Head Height (mm)	Weight (g)	Idling Speed (rpm)	Spray	Features
T3 Racer Midwest	Up to 30	Approx. 11.9	Approx. 13.0	Approx. 46	Approx. 400,000	4	1.6 FG
T3 Racer Borden	Up to 30	Approx. 11.9	Approx. 13.0	Approx. 46	Approx. 400,000	4	1.6 FG
T3 mini Midwest	Up to 24	Approx. 10.2	Approx. 12.7	Approx. 47	Approx. 410,000	4	1.6 FG
T3 mini Borden	Up to 24	Approx. 10.2	Approx. 12.7	Approx. 47	Approx. 410,000	4	1.6 FG

Types	Item Number
T3 Racer Midwest	6460385
T3 Racer Borden	6460427
T3 mini Midwest	6601731
T3 mini Borden	6601756

"I will only consider instruments which offer good value for money."





T3 Turbines - Quick Coupling

Continued cost-effectiveness

The titanium-coated turbines of the T3 Class are easy to clean and have a good grip. Up to 23 watts of power and ceramic ball bearings ensure efficient work for a long time. In other words: lasting efficiency.

- Up to 23 watts for high torque
- Double back-suction stop (protective head system)
- Robust ceramic ball bearings
- Quick-stop function: Quick burr run-down time
- Unbelievably quiet thanks to the 4-nozzle spray
- Suitable for all common quick-coupling versions (Click & Go)
- Clamping system with low vibration

T3 mini: With the extra small mini head options you receive optimum access to the molar region and an optimal view of the preparation site. T3 mini has an impressive head size (height: 12.7mm, diameter: 10.2mm) to torque ratio.

T3 Boost: The robust T3 Boost does it all! The titanium-plated turbine stands out due to its ease of use and has the required power to satisfy every requirement.

Technical data overview:

Types	Power (w)	Head diameter (mm)	Head height (mm)	Weight (g)	Idling speed (rpm)	Spray	Features	Indication
T3 Boost	Up to 26	Approx. 11.4	Approx. 13.0	Approx. 54	Approx. 370,000	4	1.6 FG	Cavity preparation
T3 mini	Up to 21	Approx. 9.7	Approx. 12.7	Approx. 53	Approx. 410,000	4	1.6 FG	Cavity preparation

Types / Item Number	Dentsply Sirona Connection	KaVo ¹ Connection	W&H ¹ Connection	NSK ¹ Connection
T3 Boost	66 89 801	66 89 827	6387935	6387943
T3 mini	66 89 843	66 89 868	6387976	6387984

Dentsply Sirona quick coupling/Ref.	F, without return airflow
4-hole standard interface with light, spray control and back suction stop	41 74 467



"I like my turbines to be cost-effective but still to a high quality"



T4 Turbines

The entrance to the Dentsply Sirona world

The high-speed turbine of the T4 Class convinces with its combination of an essential design and exceptional high power level of up to 26 watts. Regardless which treatment unit you use, with Midwest 4-hole and Borden 2-hole you have always the right choice.

- Essential design out of stainless steel
- Ceramic ball bearings
- Single spray
- Up to 26 watts
- Push button chuck



Technical data overview:

Types	Head Diameter (mm)	Head Height (mm)	Weight (g)	Idling Speed (rpm)	Spray	Features
T4 Racer Midwest	Approx. 11.9	Approx. 13.0	Approx. 48	Approx. 400,000	Single	1.6 FG
T4 Racer Borden	Approx. 11.9	Approx. 13.0	Approx. 48	Approx. 400,000	Single	1.6 FG

Types	Item Number
T4 Racer Midwest	6624394
T4 Racer Borden	6624402



Turbine Accessories

Turbine Quick Couplings

6319706	Sirona quick coupling R (LED), for T1/T2 Turbines 4 hole standard connection with LED light, spray regulation and with anti-retraction stop. For units ensuring exhaust of drive air via the supply hose.
1894588	Sirona quick coupling R, for T1/T2 Turbines 4 hole standard connection with light, spray regulation and with anti-retraction stop. For units ensuring exhaust of drive air via the supply hose.
4174467	Sirona quick coupling F, for T1/T2 Turbines 4 hole standard connection with light, spray regulation, and with anti-retraction stop. For units without exhaust of drive air in the unit. Drive air exhausts between quick coupling and hose connection to avoid power-impairing anti-retraction.

5861724	Sirona quick coupling B, for T3 Turbines 4 hole standard connection without light, without spray regulation and with anti-retraction stop. For units without exhaust of drive air in the unit. Drive air exhausts between quick coupling and hose connection to avoid power-impairing anti-retraction.
---------	--

Lamps

6314558	Dentsply Sirona LED For the BL/BL E and BL ISO motors (not the BL ISO C/E/S motors) as well as the SL/SL ISO and EL1 motors; compatible with the brown and green halogen lamps. The LED can be used in the following Dentsply Sirona treatment centers: M1-90, M1-94, M1-96, Sirona E, C2, C2+, C3, C3+, C4, C4+, C5+, C6, C8, C8+, M1+, Profeel, Profeel+, Teneo, Sinus, Intego and Intego Pro.
5940291	Lamp (brown) for Sprayvit L

Straight and contra-angle handpieces

The straight and contra-angle handpiece program from Dentsply Sirona is characterised by high flexibility. They are the perfect tools for standard preparations like processing fissures, removing tooth enamel and dentin, refining the edge of the cavity or placing pins. With their vast variety of versions they are also ideal for prosthodontics, micropreparation, surgery, endodontics and prophylaxis.



INSTRUMENTS / STRAIGHT AND CONTRA-ANGLE HANDPIECES

T1 Classic

Perfection in balance

T1 Classic is first-class technology. The ideal positioning of the SL motor in the light titanium sleeve ensures that it fits perfectly balanced in your hand. Challenging jobs become child's play and your preparation results are of the finest quality.

Benefits at a glance:

- Superior balance with SL/BL motor
- Ergonomic flowing design
- Especially light thanks to the thin titanium sleeves
- Optimal illumination for great visibility during treatments
- Perfect hygiene: sterilisable, thermally disinfectable

Ergonomic

- New sleeve design for even better handling
- Low noise level
- Good view of the preparation side

Durability

- LongLife Technology: DLC coated ceramic ball bearings*
- 3 year guarantee / Made in Germany
- Titanium (corrosion free)

Hygiene

- Thermally disinfectable
- Smooth biocompatible titanium surface
- Anti retraction valve

"I only want to use the best and most effective instruments on my patients."

T1 Classic straight and contra-angle handpieces for standard preparations

T1 Classic S 200 L

Ideal for cavity and crown preparations

T1 Classic S 40 L, T1 Classic S 6 L / S 1,6 L, T1 Classic

Ideal for finishing and excavating

T1 Classic SH 40 L

The straight handpiece is especially well suited to the low speed range. Precision prosthodontics can thus be performed either chairside or in the laboratory. The straight shape of the handpiece is optimally suited to surgical applications.

Types	Item Number
T1 Classic S 200 L	5898866
T1 Classic S 40 L	5898874
T1 Classic S 6 L	5898882
T1 Classic S 1.6 L	5898890
T1 Classic SH 40 L	6031400

T1 Classic straight and contra-angle handpieces for special applications

T1 Classic Prophy - For prophylaxis

This contra-angle handpiece enables brilliant polishing of teeth and material surfaces in connection with brushes and caps.

T1 Classic EVA 04 L / 11 L - For micro-preparations

Due to the flexibility of the file adjustment, this contra-angle handpiece is especially good for polishing and removing composite residues and smoothing root surfaces.

T1 Classic Endo L - For endodontics

The 2-in-1 root canal preparation principle is based on offering a single contra-angle handpiece that enables efficient use of hand files and mechanically operated steel files.

T1 Classic KM 1.6 L - For surgery

The Kirschner/Meyer principle, in which the rinsing liquid/coolant is discharged directly in the milling area at the burr tip, enables atraumatic preparation and optimally supports surgical interventions.

Type	Item Number
T1 Classic Prophy	5899278
T1 Classic EVA 04 L	5899237
T1 Classic EVA 11 L	5899245
T1 Classic Endo L	5899260

*Longer service life due to DLC (diamond-like carbon) coated ball bearings.



INSTRUMENTS / STRAIGHT AND CONTRA-ANGLE HANDPIECES

T1 Line

Stay flexible with ease

The high-quality straight and contra-angle handpiece series T1 Line excels due to its ergonomic design. It sits feather-light in your hand thanks to the titanium sleeves. This guarantees fatigue-free working and precise results. You stay flexible with the ISO interface, regardless of the treatment centre you are using.

The T1 Line offers you these benefits:

- 3-year warranty
- Longer service life thanks to DLC coated ball bearings
- Optimal illumination for an excellent view
- A universal ISO interface
- Adaptability to motors with light thanks to the ISO Slider®

T1 Line straight and contra-angle handpieces for standard preparations

- T1 Line C 200 L - For standard preparations
Ideal for cavity and crown preparations
- T1 Line C 40 L - For standard preparations
Ideal for finishing and excavating
- T1 Line C 6 L / C 1,6 L - For standard preparations
Ideal for finishing and excavating
- T1 Line H 40 L - For prosthodontics
The straight handpiece is especially well suited to the low speed range. Precision prosthodontics can thus be performed either chairside or in the laboratory. The straight shape of the handpiece is optimally suited to surgical applications.

Type	Item Number
T1 Line C 200 L	3328452
T1 Line C 40 L	3328437
T1 Line C 6 L	3328429
T1 Line C 1.6 L	3328411
T1 Line H 40 L	6031277

"I need to stay flexible whilst using instruments with good ergonomics, durability and hygiene."

T1 Line straight and contra-angle handpieces for special applications

- T1 Line Prophy - For prophylaxis
This contra-angle handpiece enables brilliant polishing of teeth and material surfaces in connection with brushes and caps.
- T1 Line EVA 04 L / 11 L - For micro-preparations
Due to the flexibility of the file adjustment, this contra-angle handpiece is especially good for polishing and removing composite residues and smoothing root surfaces.
- T1 Line Endo L - For endodontics
The 2-in-1 root canal preparation principle is based on offering a single contra-angle handpiece that enables efficient use of hand files and mechanically operated steel files.
- T1 Line Endo 6 L - For endodontics/endometry
In combination with the ApexLocator, the Endo 6 L allows for localisation of the apex without a file clamp. The extra small head ensures that the dentist has the best possible view of the root canal.
- T1 Line Condens - For amalgam fillings
Amalgam fillings can be easily condensed using the contra-angle handpiece Condens combined with Dentatus AVA tips.

Type	Item Number
T1 Line Prophy	1894901
T1 Line EVA 04 L	3329260
T1 Line EVA 11 L	4177015
T1 Line Endo L	5869552
T1 Line Endo 6 L	6527191





INSTRUMENTS / STRAIGHT AND CONTRA-ANGLE HANDPIECES

T2 Line

The comfortable solution

T2 Line is the robust straight and contra-angle handpiece series of the comfort class. This is where the Dentsply Sirona quality and know-how come together providing this unique product range. With its functionality and reliability, you will be able to concentrate wholeheartedly on treating the patient.

Benefits at a glance:

- Universal ISO interface
- Pleasant and easy to grip thanks to its titanium sleeves
- Robust ceramic ball bearings
- ISO slider® for motor with illumination
- 2 years guarantee
- Optimal illumination for great visibility during treatments
- Perfect hygiene: sterilisable, thermally disinfectable

Technical data overview:

Types	Gear Ratio/Reduction	Speeds	Head Diameter (mm)	Head Height (mm)	Features	Indication
T2 Line A 200 L	1:5	Up to approx. 200,000	Approx. 8.7	Approx. 14.6	Dia 1.6 FG	Cavity and crown preparation
T2 Line A 40 L	1:1	Up to approx. 40,000	Approx. 8.7	Approx. 12.4	Dia 2.35 WB	Finishing
T2 Line A 6 L	6:1	Up to approx. 6,000	Approx. 8.7	Approx. 12.4	Dia 2.35 WB	Excavating
T2 Line AH 40 L	1:1	Up to approx. 40,000	-	-	Dia 2.35 HB/WB	Preparation

Types	Item Number
T2 Line A 200 L	6376177
T2 Line A 40 L	6376185
T2 Line A 6 L	6376193
T2 Line AH 40 L	6376201

"Quality counts. I need instruments that I can rely on."

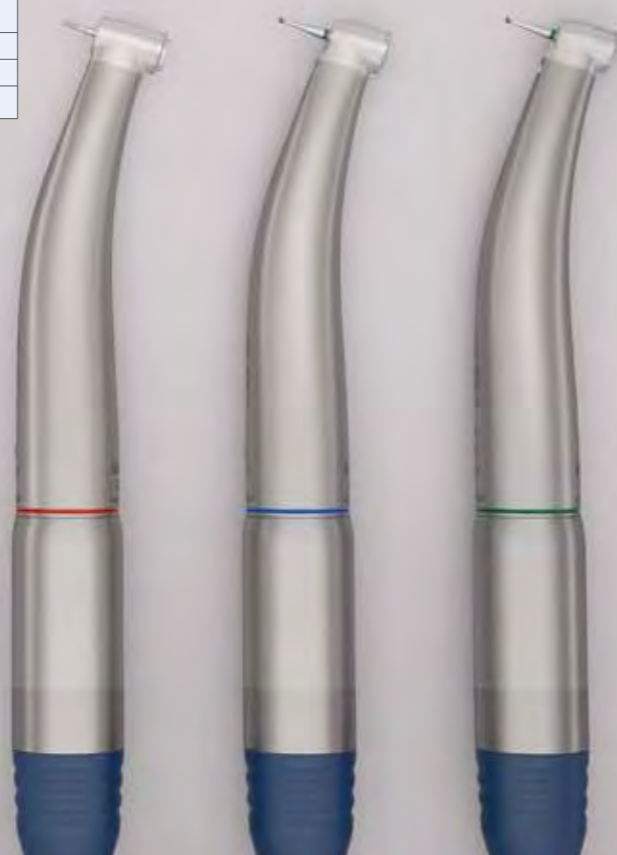

INSTRUMENTS / STRAIGHT AND CONTRA-ANGLE HANDPIECES

T3 Line

Continued cost-effectiveness

The straight and contra-angle handpieces of the T3 Class with their extremely robust titanium sleeves are sturdy and an investment that will provide satisfaction for years to come. Thanks to the ISO interface, you remain completely flexible - no matter which treatment center you are using.

Benefits at a glance:

- Perfect hygiene: sterilisable, thermally disinfectable
- Ceramic ball bearings
- Good price-performance ratio
- Proven features
- High availability

Technical data overview:

Types	Gear Ratio/Reduction	Speeds	Head Diameter (mm)	Head Height (mm)	Features	Indication
T3 Line E 200	1:5	Up to approx. 200,000	Approx. 8,7	Approx. 14.6	Dia 1.6 FG	Cavity and crown preparation
T3 Line E 40L	1:1	Up to approx. 40,000	Approx. 8,7	Approx. 12.4	Dia 2.35 WB	Finishing
T3 Line E 6	6:1	Up to approx. 6,000	Approx. 8,7	Approx. 12.4	Dia 2.35 WB	Excavating
T3 Line EH 40	1:1	Up to approx. 40,000	-	-	Dia 2.35 HB/WB	Preparation

Types	Item Number
T3 Line E 200	6392679
T3 Line E 40	6392687
T3 Line E 6	6392695
T3 Line EH 40	6392711

"I want to benefit from proven products. I choose the cost-effect option from the economy class."





INSTRUMENTS / STRAIGHT AND CONTRA-ANGLE HANDPIECES

T4 Line

The entrance to the Dentsply Sirona world

The straight and contra-angle handpiece of the T4 Class delivers with an essential design and a robust steel sleeve. Due to the air motor – available with Midwest 4-hole or Borden 2/3-hole – you will stay flexible, regardless of the treatment unit you are using.

- Essential design made out of stainless steel
- External spray
- Push button chuck
- For use with burs that have a 2.35mm burr shaft diameter

Technical data overview:

Types	Speed	Spray	Head Diameter (mm)	Head Height (mm)	Weight (mm)	Equipment (mm)
T4 Line B 40	Max. 40,000*	External	Approx. 8,7	Approx. 12.4	Approx. 72	2.35 WB
T4 Line BH 40	Max. 40,000	External	-	-	Approx. 77	2.35 WB
T4 Air MotorBM/BO	Approx. 22,000**	External	-	-	Approx. 90	-

Types	Item Number
T4 Line B 40	6401827
T4 Line BH 40	6401843
T4 Air MotorBM/BO	6439884 / 6439892

“My choice for essential working.”



INSTRUMENTS / STRAIGHT AND CONTRA-ANGLE HANDPIECES

Implant 20:1

Sophisticated down to the smallest detail

Implant 20:1 is equipped with high-quality, precise gears that offer you optimal speed and torque (up to 70Ncm) for all drilling and shaping applications. The extremely small head diameter provides the best view of the preparation site. Implant 20:1 is therefore ideally suited for all implant and surgical work.

Powerful and flexibly applicable

- The contra-angle handpiece works with the ISO interface
- Due to its maximum speed of 2,000rpm and its high torque of up to 70Ncm, it is suitable for all drilling and shaping applications
- Cooling is possible with an internal and external spray
- It can be used for everything from smoothing the alveolar crest to screwing in the implants

Hygienic

- The contra-angle can be dismantled easily without any tools
- The handpieces can be sterilised and thermally disinfected

Implant 20:1

6043702

With push-button chuck for drills (2.35mm) with internal and external cooling spray for saline solution, reduction 20:1

“The Implant 20:1 contra-angle handpiece is the perfect complement to my Teneo treatment centre and caters for a complete spectrum of assignments in the area of implantology and surgery.”





INSTRUMENTS / ENDO MOTOR AND CONTRA-ANGLE HANDPIECE

Endo 6:1

The optimal contra-angle handpiece for root canal preparation

In combination with an apex locator, the compact Endo 6:1 contra-angle handpiece facilitates the localisation of the apex without the need for a file clamp. Length measurement takes place directly via the handpiece. The extremely compact head ensures that the dentist has the best possible view of the root canal. The slim-line design without a file contact clip is the passport to perfect ergonomics. Thanks to the practical ISO interface, the user has a free choice of micromotors.

The new insulation sleeve enables safer apex location: Just pull the single-use sleeve over the handpiece and sterilise the instrument after treatment. The contra-angle handpiece can be sterilised and thermally disinfected.

Endo 6:1
5994277

Isolation sleeve for Endo 6:1
handpiece (5 per pack)
6324631

“Compact design and extremely small head ensure lots of space for the treatment.”

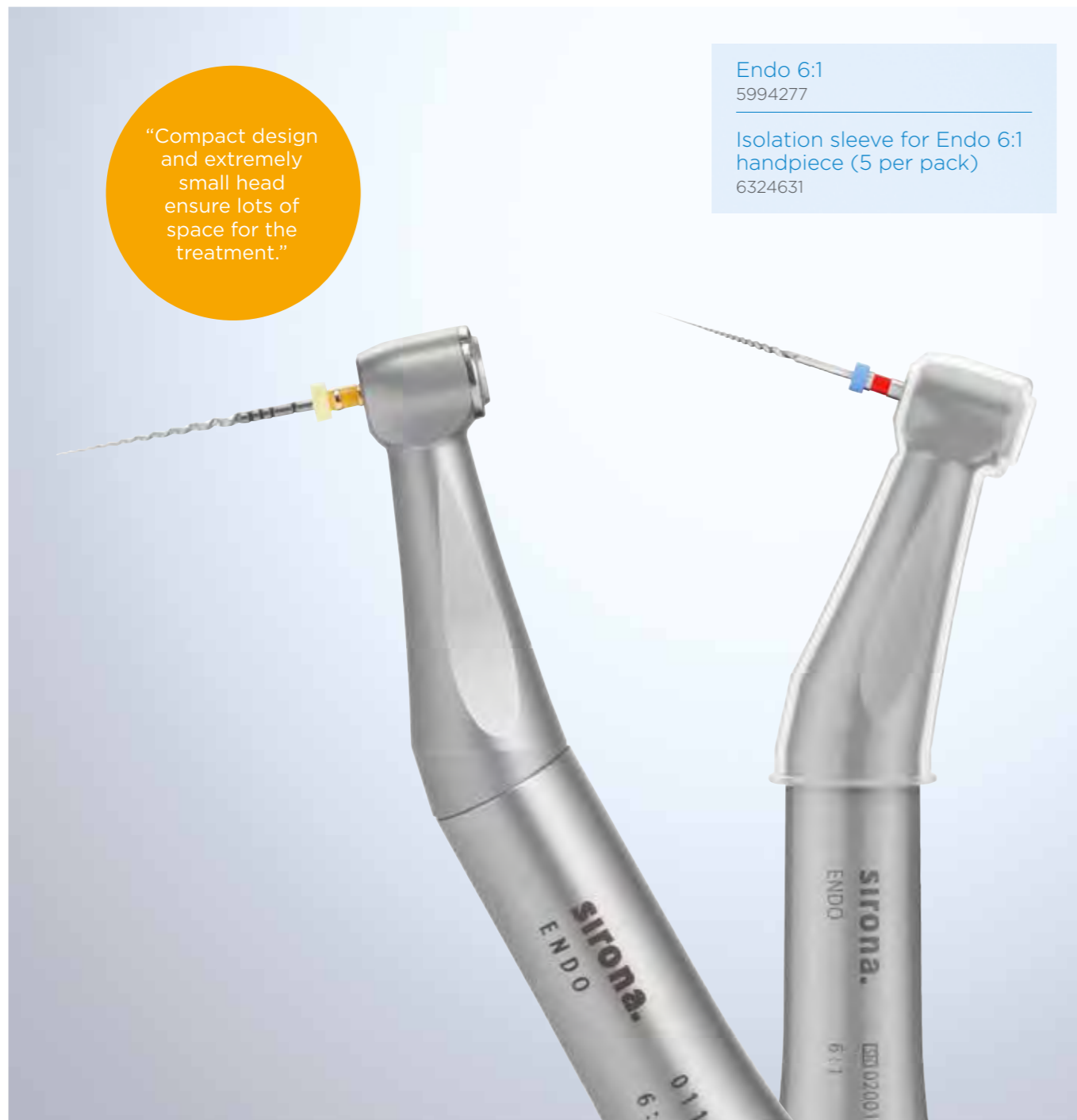

INSTRUMENTS / ENDO MOTOR AND CONTRA-ANGLE HANDPIECE

SiroNiTi Apex/SiroNiTi Air Plus Apex

Safety is as valuable as gold

With the contra-angle handpieces SiroNiTi Apex and SiroNiTi Air Plus Apex for connection to an apex locator, you'll always have just the right equipment. Both handpieces are equipped with a torque limitation function: Once the set torque has been reached, the gold-plated magnetic coupling prevents jamming of the file in the root canal by retro-rotation.

The SiroNiTi Air Plus Apex handpiece can be operated with air motors as well as electric motors. In combination with an electric motor, the SiroNiTi Air Plus enables the deployment of file systems with a higher permissible speed.

The SiroNiTi Apex/SiroNiTi Air Plus Apex handpieces facilitate the convenient localisation of the apex. An apex locator can be attached directly via the golden clip. A file clamp is not necessary.

The contact pins on the gold clips are available with a diameter of 2 and 1.5mm.

“The handpieces are supplied with Torque Cards which indicate the torque setting for your chosen file system.”



Types	Description	Item Number
SiroNiTi Apex	<ul style="list-style-type: none"> • Contra-angle for root canal preparation • In combination with the gold clip for the connection of an apex locator • For electric and air motors • Gear ratio/reduction = 66.1 • Max. operating speed = 350rpm 	6174234
SiroNiTi Apex	<ul style="list-style-type: none"> • Contra-angle for root canal preparation • In combination with the gold clip for the connection of an apex locator • For air motors only • Gear ratio/reduction = 115.1 • Max. operating speed = 600rpm 	6324615
Clip 2mm diameter (gold plated)	N/A	6345230
Clip 1.5mm diameter (gold-plated)	N/A	6345248



Our new Turbine Generation

Power is not a Matter of Size

More power, smaller heads and less weight - The turbines of the premium class lie ideally balanced in your hand. No matter if you choose T1 Boost, T1 mini or T1 Control: all turbines offer high power, give you full control at all times and are working very quietly. Due to its small head, T1 mini allows for outstanding sight, T1 Boost offers maximum power at a whisper tone and T1 Control works continuously and at low noise due to its patented speed break.

dentsplysirona.com/turbines

THE DENTAL SOLUTIONS COMPANY™



INSTRUMENTS / ULTRASONIC SCALER AND TIPS

SiroSonic L and SiroSonic TL

Unlimited ultrasonic applications

A great combination: The ideal result - regardless of the type of treatment - depends on the ideal combination of scaler and tip. By optimally matching the two components, Dentsply Sirona ensures consistent high quality. This has produced ultrasonic scalers that are flexible and easy to use with a selection of tips designed to be used in specific treatment areas.

SiroSonic L and SiroSonic TL ultrasonic handpieces go above and beyond satisfying the increasing requirements and demands of a modern dental practice. The power control enables dentists to use it to perform sensitive periodontal treatments requiring a low power setting as well as for micro-preparations. SiroSonic L, and SiroSonic TL also feature powerful lighting for optimal illumination of the oral cavity.

Versatile with a range of tips

- Preventive and periodontal treatments can be performed optimally
- Additional applications include rinsing and retrograde preparation of root canals
- Preparing cavities as well as placing inlays can both be performed easily

Powerful and controlled treatment

- The controlled, linear oscillations generate high cavitation effects at the tip of the instrument
- Optimal control of power and water right on the handpiece

Hygienic

- Handpiece and tips can be sterilised
- External rinsing fluids can be used with the corresponding spray adapters



Scalers:

Type		Description	Item Number
SiroSonic ¹		Without light, incl. no. 3L and no. 4L tips	5913517
SiroSonic L ¹		With light, incl. no. 3L and no. 4L tips	5913509
Set SiroSonic L ¹		With light, 2 per box	6562834
SiroSonic TL ²		With light, incl. no. 3L and no. 4L tips	6212216
Set SiroSonic TL ²		With light, 2 per box	6562842

Scaler Accessories:

Type		Application	Item Number
Spray adaptor		For SiroSonic/SiroSonic L or use with externally supplied special rinsing fluids	6002286
Spray adaptor		For SiroSonic TL for use with externally supplied special rinsing fluids	6141852
Torque key		For fastening the tip to the handpiece securely	6006196

¹ Suitable for Intego and Intego Pro
² Suitable for Sinus and Teneo



Matching tips for Scaling:

Type		Application	Item Number
Tip no. 1L*		For initial lingual and buccal scaling	8924250
Tip no. 2L*		Versatile, lingual, buccal and approximal	8924268
Tip no. 3L*		Universal bilateral, subgingival and interdental	1894455
Tip set no. 3L* (2 per box)		See tip no. 3L	6412451
Tip set no. 3L* (6 per box)		See tip no. 3L	6541044
Tip no. 4L*		Universal, ideal for supragingival and subgingival tooth surfaces and interdental areas	1894463
Tip set no. 4L* (2 per box)		See tip no. 4L	6412469
Tip set no. 4L* (6 per box)		See tip no. 4L	6541051

Matching tips for Micro-Preparation:

Type		Description	Item Number
SiroPrep M1* Small		Mesial	5904276
SiroPrep D1* Small		Distal	5947309
SiroPrep M2* Standard		Mesial	5947358
SiroPrep D2* Standard		Distal	5947366
SiroPrep-Set, comprising: SiroPrep M1/M2 and D1/D2, incl. torque wrench			5950253

Matching tips for Periodontology:

Type		Description	Item Number
SiroPerio PE1* straight bristles		For rinsing and cleaning roots in deep gingival pockets	6044825
SiroPerio PE2* right curvature		For cleaning roots in deep gingival pockets in the posterior area	6044833
SiroPerio PE3* left curvature		For cleaning roots in deep gingival pockets in the posterior area	6044841
SiroPerio 4 PS* especially for use with PerioScan		For detection and root scaling in deep gingival pockets with PerioScan	6177005
SiroPerio PE5* right curvature		For cleaning roots in deep gingival pockets in the posterior area	6343078
SiroPerio PE6* left curvature		For cleaning roots in deep gingival pockets in the posterior area	6343086

Matching tips for Filling Therapy:

Type		Description	Item Number
CEM-Set Nr. 6L*, including: 1 CEM-Tip No. 6L, 2 Contact inserts for inlays		For inserting ceramic inlays (i.e. CEREC) with thixotropic composites	1894307
Contact attachment		For CEM tip No. 6L, for inlays (10 per box)	1894372

Matching tips for Implantology:

Type		Description	Item Number
SiroImplant IP1 only for SiroSon L, SiroSonic/L/TL		For cleaning implants as well as metal and ceramic restorations	6343052
Insert IP1 for SiroImplant IP1		Scope of delivery: (5 per box)	6343094

Matching tips for endodontics:

Type		Description	Item Number
Endo tip No. 5 only for SiroSon L, SiroSonic L, SiroSonic TL		For rinsing root canals with NaOCl	6002310
Knurled bush and endo key for Endo tip No. 5		Application For rinsing root canals with NaOCl For tightening the clamping forceps for assembling, disassembling the Endo tip	1895080

Matching tips for Retrograde Root Treatment:

Type		Description	Item Number
SiroRetro KR* Short, angled to the right		For the lower left jaw or upper right jaw	5457895
SiroRetro KL* Short, angled to the left		For the lower right jaw or upper left jaw	5457887
SiroRetro GR* Long, angled to the right		For the lower left jaw or upper right jaw	5457911
SiroRetro GL* Long, angled to the left		For the lower right jaw or upper left jaw	5457903
SiroRetro set, consisting of: SiroRetro KR/KL und GR/GL, incl. torque wrench			5457929

Motors

Power you can rely on

Dentsply Sirona's electric motors cover a very wide range of speeds, and therefore can be used for many different tasks in the dental practice. They stand for exceptional reliability and durability and impress with their superb performance features.

Huge in versatility

The wide range of speed of Dentsply Sirona motors ensures a wide variety of applications. The constantly high torque is optimally adapted through electronic compensation to each work situation. The interfaces are very diverse with the Dentsply Sirona interface, ISO standard, INTRAmatic®, or INTRAmatic® Lux.

Always ergonomic

Dentsply Sirona is the unique supplier of two interfaces:

Motor BL/BL E/SL for T1 Classic as well as BL ISO C/E and SL ISO for the T1/T2/T3 Line and T2/T3 S-Line. The contra-angle handpiece feels very well balanced in the hand, especially with the T1 Classic with built-in BL/BL E/SL motor.



INSTRUMENTS / MOTORS AND SYRINGES

SL and SL ISO Motor

Proven, robust and reliable

Durable, robust, and hygienic

- With 200 to 40,000 revolutions per minute, the SL and SL ISO collector motors from Dentsply Sirona facilitate a broad range of applications
- A soft start and stop protects the motor as well as the straight and contra-angle handpieces.
- Freely rotating hose prevents spin effect
- The SL ISO motor's removable adapter can be sterilised
- For Dentsply Sirona C Line treatment centres

Type	Version	Item Number
SL motor	-	4176710
SL ISO motor	SL motor and adapter ISO	6035989
ISO adapter	with light and spray	6000793
Basic adapter (Apex)	with light, without spray	5983072



INSTRUMENTS / MOTORS AND SYRINGES

BL/BL E and BL ISO C/E and BL Implant Motors

The powerful and brushless micromotors

Brushless, compact and hygienic

- The brushless Dentsply Sirona Motors BL are not only extra short, they also belong to the world's lightest and most ergonomic motors
- These brushless micromotors are optimal electronically controlled
- Motors BL/BL E and BL ISO C/E have an anti-retraction stop
- Motors and adapters are sterilisable and maintenance free

Only the best in performance

- Constant maximum torque over a wide speed range from 90-40,000rpm (depending on combination of Dentsply Sirona motor and treatment centre: see technical data for details)
- The microprocessors also provide quiet and stable operation at rapidly changing loads
- Motor BL/BL E and BL ISO C/E support the Apex-function according to the configuration of the treatment centre
- The slim and lightweight implantology Motor BL Implant with internal cooling provides a max. torque of 5Ncm and no air is emitted at the treatment site



Type	Description	Item Number
BL Motor	Brushless motor with LED, torque max. 2.4Ncm, sterilisable. Suitable for T1 Classic system with Sirona-interface. In connection with Teneo/Sinius. 2 years guarantee.	6319714
BL E Motor	Brushless motor with LED, torque max. 2.4Ncm, sterilisable. Suitable for System T1 Classic with Sirona interface in combination with Intego and Intego Pro. 2 years guarantee.	6546225
BL ISO C Motor	Very short, brushless motor with LED, torque max. 3.0Ncm, sterilisable. Suitable for T1/T2/T3/T4 Line and T2/T3 S-Line system with ISO 3964 interface, INTRAmatic® LUX. In connection with Teneo/Sinius. 2 years guarantee.	6337518
BL ISO E Motor	Very short, brushless motor with LED, torque max. 3.0Ncm, sterilisable. Suitable for T1/T2/T3/T4 Line and T2/T3 S-Line system with ISO 3964 interface, INTRAmatic® LUX. 2 years guarantee.	6445899
Motor BL Implant	Powerful brushless motor for implantology applications torque max. 5.0Ncm, sterilisable. Neither light nor spray, no discharge of air. Suitable for Implant 20:1 with ISO interface INTRAmatic®. In connection with Teneo. 2 years guarantee.	6212208

INSTRUMENTS / MOTORS AND SYRINGES

Sprayvit

Multifunctional syringe with or without light

Sprayvit, Dentsply Sirona's multifunctional syringe, guarantees controlled examinations. With optional pinpoint lighting, built-in heater, and rotatable nozzle, Sprayvit adapts optimally to the particular requirements.

Comfortable and flexible treatment

- 360° freely rotatable nozzle
- Pinpoint lighting of up to 25,000 Lux for preparation control
- Nozzle G with light is optimally suited to the initial examination
- Adhesive dentistry is made possible with dry air
- All media quickly heat up to physiological temperatures

Safe and hygienic down to the last detail

- All media are separated until the outlet
- Highest reliability is ensured even with hard tap water
- Outer sleeves and nozzles are easily removable and sterilisable
- The replaceable keypad is easy to clean
- The back-suction stop valve prevents the absorption of spray water



"Keep your examinations completely under control."

Type	Version	Item number
Sprayvit M, 5-way (Sinus and Teneo)	Including nozzle G (long), with LED, Spray water heated, water button on the right	6321793
	Including nozzle G (long), with LED, Spray water heated, water button on the left	6321801
Sprayvit E, 3-Way (Intego Pro)	Including nozzle (short), with LED, without heating, water button on the right	6436195
	Including nozzle (short), with LED, without heating, water button on the left	6436203

Accessories:

Type	Version	Item Number
Nozzle G	Long, bent, with light	5992180
	Long, bent, without light	5992206
Sprayvit nozzle G set (6 per pack)	Long, bent, with light	6541226
Nozzle (option for assistant) SiroSonic TL	Short, straight, with light	4177783
	Short, straight, without light	5992198
Handpiece sleeve, for regular sterilisation	Right water line	6002179
	Left water line	6002187
LED	For Sprayvit E/M	6322007
Keypad	-	6321728

Instrument reprocessing is of utmost importance in the dental practice

Do you know Dentsply Sirona's hygiene cycle in machine instrument reprocessing?



THE DENTAL SOLUTIONS COMPANY™



Laser

In order to provide the highest level of care we must embrace technology. Dentistry is constantly changing, and numerous devices continue to be developed that promise amazing advantages. Dental diode lasers deliver clear benefits over conventional methods of treatment with mostly scar-free wound healing and improved germ reduction. For patients, the use of lasers means less post-operative pain and therefore less need for medication. Not only that, but your practice benefits too, because satisfied patients are the best way to ensure success.



LASER / DIODE LASER

SiroLaser Blue

The magic of the colour blue

The compact SiroLaser Blue is the first dental diode laser to have a blue, infrared, and red diode. This enables it to cover more than 20 indications and therefore opens up versatile possibilities for application in your practice routine. The SiroLaser Blue is also one of the smallest and handiest models on the market and also features significantly better cutting efficiency by means of its blue wavelength compared to conventional infrared diode lasers. You remain flexible and mobile in your practice.

Compared to traditional treatment methods, the compact SiroLaser Blue offers significantly better wound healing and improved germ reduction. For your patients, the SiroLaser Blue means virtually pain-free treatment and thus a lower dose of anesthetic.

Outstanding cutting performance

- Best cutting performance of a diode laser thanks to the blue 445nm diode
- More precise, quicker and cleaner treatment

Unlimited possibilities

- Multi-diode technology: 1 device - 3 wavelengths: 445nm (for cutting efficiency), 660nm (for low-level laser therapy) and 970nm (for disinfection)
- Extremely broad range of applications
- Additional soft laser applications with therapy light guide

Ergonomic and intuitive handling

- New, ergonomic stainless steel handpiece with an integrated finger switch for even more fatigue-free work
- Sterile disposable fiber tips for simple and quick fiber management
- Pre-set treatment programs and battery operation

Other properties

- Touch screen
- Help menu for all pre-set treatment programs
- 24 freely programmable applications
- 6 favourites can be saved in hotkeys
- Data from all treatments can be saved
- Output via USB port
- Optional: Wireless foot control

Versatile Possibilities

- Implantology
- Periodontology
- Endodontics
- Surgery
- CEREC/prosthetics
- Laser therapy
- Desensitisation
- Medical bleaching

SiroLaser Blue

6559111

Comprising:

- 1x SiroLaser Blue control unit
- 1x Battery pack (mounted)
- 1x Stainless steel handpiece with integrated finger switch
- 1x Additional stainless steel handpiece sleeve for alternating operation
- 1x Demo set of disposable (non-sterile) fiber tips (2x EasyTip 320µm, 2x EasyTip Endo 200µm, 2x EasyTip 200µm)
- 1x Fibercutter
- 2x EasyBend bending tool
- 3x Laser safety goggles (for dentist, assistant and patient)
- 5x Optic protective cap



LASER / DIODE LASER

SiroLaser Advance Plus

A plus for your practice

SiroLaser Advance Plus is a diode laser having an infrared and a red diode. The established infrared 970nm wavelength covers all indications in the field of soft-tissue surgery, periodontology and endodontics. The additional red 660nm diode is used for what is known as "Low-Level-Laser Therapy (LLLT)".

The SiroLaser Advance Plus is designed for experts and less experienced users alike. With SiroLaser Advance Plus, you'll enjoy intuitive and versatile use to fully concentrate on each patient.

Versatile operation

- Ergonomic handpiece with light-touch finger switch
- Battery-operated for greater portability
- Additional 660nm diode for Low-Level-Laser Therapy (LLLT)

Immediate treatment

- Pre-set programs for key applications
- Optional help menu for each pre-set program to assist less experienced users
- Disposable fibers (EasyTips)

Intuitive handling

- Touchscreen navigation
- Clear user prompts
- Self-explanatory menu icons

Individual customisation

- 24 programmable applications
- User profiles, each with a personal access code

Indications:

- Implantology
- Periodontology
- Endodontics
- Surgery
- CEREC/prosthetics
- Laser therapy
- Desensitisation
- Medical bleaching

SiroLaser Advance Plus

6575505

Comprising:

- 1x SiroLaser Advance Plus including stainless steel handpiece with integrated finger switch
- 1x Battery pack (already mounted)
- 1x Additional stainless steel handpiece sleeve for alternating operation
- 1x Demo set of disposable (non-sterile) fiber tips (2x EasyTip 320µm, 2x EasyTip Endo 200µm, 2x EasyTip 200µm)
- 1x Fibercutter
- 2x EasyBend bending tool
- 3x Laser safety goggles (for dentist, assistant and patient)
- 5x Optic protective cap



LASER / ACCESSORIES

SiroLaser Blue and SiroLaser Advance Plus Accessories

6487784	Handpiece sleeve with keypad	6541515	Laser goggles for users - SiroLaser Blue
6498062	EasyTip 320µm (25 per pack)	6546407	Laser goggles for spectacle wearers - SiroLaser Blue
6498484	EasyTip 200µm (25 per pack)	6541523	Laser goggles for patients - SiroLaser Blue and SiroLaser Advance Plus
6535905	EasyTip Endo 200µm (25 per pack)	6541564	Laser goggles for user - SiroLaser Advance Plus
6541465	MultiTip 8mm (therapy light guide for Low Level Laser Therapy (LLLT))	6541572	Laser goggles for spectacle wearers - SiroLaser Advance Plus
6541499	MultiTip 4mm (therapy light guide for Low Level Laser Therapy (LLLT))	6625177	Laser loupe glasses flip-up with exchangeable lenses (magnification: 3.0x; working distance: 400mm)
6579580	Optic protective cap for handpiece (5 per pack)	6625169	Laser loupe glasses flip-up with exchangeable lenses (magnification: 3.0x; working distance: 350mm)
6091669	Fibercutter		
6618180	EasyBend bending tool (2 per pack)		
6256841	Wireless foot control		
6256833	Rechargeable battery pack		

Perceptibly less stress and significantly faster recovery for your patients

Painless, gentle and fast-healing laser therapy with SiroLaser means:

- Reduction of painful inflammation and swelling
- Improved wound healing, usually without scars
- Reduced need for painkillers and antibiotics
- Surgery without scalpel

Some of the ways how laser therapy with SiroLaser helps to speed up treatment and recovery:

- Disturbing lip and tongue frenula are removed without any bleeding or pain
- Germs and bacteria in the root canal are reduced gently and effectively
- Germs and bacteria in diseased gingival pockets are eliminated softly and safely

Herpes and aphthae can also receive targeted treatment – for quick relief of the symptoms.

THE DENTAL
SOLUTIONS
COMPANY™

Dentsply
Sirona

Infection Control Systems

Practice hygiene is becoming ever more important, and with such significance comes increased monitoring. Ensure all-round protection for yourself, your practice team and your patients by using instrument reprocessing with a high level of hygienic safety and comprehensive documentation options. In principle, straight handpieces, contra-angle handpieces and turbines must be reprocessed after each and every patient treatment and require special care due to design cavities. Machine reprocessing increases process reliability and occupational safety for the practice staff, making it preferable to manual reprocessing.





HYGIENE / COMBINATION AUTOCLAVES

DAC Universal S

Close your hygiene gap.

The DAC Universal S cleans, lubricates and sterilizes up to six straight and contra-angle handpieces and turbines in a fully automated process. Furthermore, ultrasonic/sonic handpieces and ultrasonic/sonic tips, nozzles of multifunctional syringes and powder jet devices as well as powder jet handpieces can be reprocessed in the DAC Universal S, ensuring a high level of hygienic safety.

Easy handling

- New design and touch display with intuitive user interface
- Guided maintenance workflow Check & Clean

Fully automatic reprocessing

- Time-saving: 6 instruments in approx. 21 minutes
- Process safety through automatic program selection

Cost-effective reprocessing

- Low operating and consumption costs – no use of cleaning and disinfection chemicals and only up to 900 ml water consumption per cycle
- Low investment costs in instruments thanks to quick return to service

Legal certainty

- Cleaning and sterilization process which can be validated
- Cleaning process in accordance with EN ISO 15883-1 / - 2
- Sterilization process in accordance with EN 13060 and ISO 17665-1
- Routine Control with chemical indicator class 5 and PCD (Process Challenge Device)



NEW



Technical Data:

- Nominal power 1.3 kW
- Air connection (dry air)
- Supply pressure: 5.0 - 8.0 bar
- Max. short-term air consumption: approx. 60 l/min. at 5 bar

Water

- Demineralized or distilled water. We recommend <math>< 3 \mu\text{S}/\text{cm}</math>.

Documentation

- RS 232 standard interface: Printer or documentation software

LAN interface:

- Documentation software

Dimensions (with Blue lid)

- Height closed: 40 cm,
- height opened: 59 cm,
- width: 40 cm,
- depth: 42 cm

Minimum distance from wall/wall cabinet

- 10 cm/ 70 cm

Weight

- approx. 26 kg net, w/o packaging

DAC Universal S

6762160

Includes:

- Pink lid
- 1 bottle of NitramOil lubrication concentrate
- Water filter
- Combination filter
- Power cable
- Hose
- Screwdriver for adapter
- USB stick DAC Universal S
- Indicator holder
- 1 paper of chemical indicators (30 pcs.)

Check & Clean kit

- Check & Clean cap
- Check & Clean lid
- NitraClean cleaning tablets
- Syringe
- Cotton rolls

- Screwdriver for waste water filter
- Waste water filter incl. o-rings

Programs

"Pink Lid" program (for straight and contra-angle handpieces and turbines)

- Sterilization at: 134 °C, 3 min.
- Complete cycle time: approx. 21 min.

"White Lid" program (for ultrasonic/sonic scalers, ultrasonic/sonic tips, nozzles for multifunctional syringes and powder jet devices as well as powder jet handpieces)

- Sterilization at: 134 °C, 3 min.
- Complete cycle time: approx. 21 min.



HYGIENE / CLASS B AUTOCLAVES

DAC Premium and DAC Premium Plus

Highest standards, easily achieved

The DAC Premium line complies with the standard EN 13060 for "Class B" sterilisation and offers utmost operating comfort. The extra-large colour-touch display combined with the twin-chamber-technology (the same as hospital autoclaves) ensures highest energy efficiency, saves time and provides optimal sterilisation results in your practice. The stand-alone device is available with two sizes of sterilisation chamber: The DAC Premium has a chamber volume of 18.4 litres, and the DAC Premium Plus has a 23.8 litre chamber.

The twin chamber technology also offers a decisive advantage because the air is very quickly evacuated from the hollows of the instruments, sterilisation packages and chamber. With autoclaves of the DAC Premium class, you can quickly and easily step into the traceability of the instruments used on patients and thereby solidify your quality management.

Benefits at a glance:

- Legal certainty by meeting all relevant norms
- Documentation with printer, CF card or PC software is possible
- Intuitive operation via the colour touch display
- Sterilisation in record time, for example, quick program "B" in 20 mins (including drying)
- Energy saving mode: Automatic reduction of standby temperature
- Ideal for difficult sterilisation jobs (hollow instruments, Class A+B) e.g: surgical cassettes, turbines, straight and contra-angle handpieces

DAC Premium and DAC Premium Plus Units

Both premium vacuum sterilisers with twin chamber technology are for goods that are difficult to sterilise, such as textiles, surgical cassettes, turbines, and straight and contra-angle handpieces.

Equipped with:

- 1x tray holder for 6 trays or 3 standard tray cassettes
- 1x tray handle
- 1x tray holding frame

6526920	DAC Premium Unit (18.4 litres)
6526938	DAC Premium Plus Unit (23.8 litres)

DAC Premium and DAC Premium Plus Accessories

6539790	DAC Premium Tray Holder (for 6 trays or 3 standard tray cassettes)
6539808	DAC Premium Plus Tray Holder (for 6 trays or 3 standard tray cassettes)
6117340	Nitrarack 18 Litres (improves the drying process of packaged instruments)
6543222	Nitrarack 22 Litres (improves the drying process of packaged instruments)



HYGIENE / CLASS B AUTOCLAVES

DAC Professional and DAC Professional Plus

An investment in quality

No matter which chamber size you decide upon, with the DAC Professional autoclaves, you will be making a safe investment in first class sterilisation. The DAC Professional fulfils the requirements of modern practices and complies with the standard EN 13060 for "Class B" sterilisation by fractionated pre-vacuum. The stand-alone device is available with two sizes of sterilisation chamber: the DAC Professional has a 17 litre chamber, and the DAC Professional Plus has a 22.6 litre chamber.

Both versions are suitable for all thermostable items and types of sterilisation, for example, no additional sterilisation device is required. Operator errors are a thing of the past with the integrated display and market-tested user interface.

Benefits at a glance:

- Sterilisation results can be validated
- Works test included for simplified initial validation
- Short operating times, easy-to-use
- Variable loading options
- Documentation possible via printer, NITRAflash or PC software
- Microprocessors prevent operator errors
- Minimum care and maintenance requirements
- thanks to Water-One-Way-system
- Ideal for difficult sterilisation jobs (hollow instruments, Class A+B) - e.g: surgical cassettes, textiles, as well as straight handpieces, contra-angles and turbines
- Excellent thermal insulation minimises power consumption
- Long-life stainless steel

DAC Professional and DAC Professional Plus Units

Both professional vacuum sterilisers are for goods that are difficult to sterilise, such as textiles, surgical cassettes, turbines, and straight and contra-angle handpieces.

Equipped with:

- Tray holder for 5 trays or 3 standard tray cassettes
- 1 tray handle
- 1 tray holding frame

6093475	DAC Professional Unit (17 litres)
6536879	DAC Professional Plus Unit (22.6 litres)

DAC Professional and DAC Professional Plus Accessories

6486133	DAC Professional tray holder (for 5 open trays or 3 trays with lids)
6532233	DAC Professional Plus tray holder (for 5 open trays or 3 trays with lids)
6117340	Nitrarack 18 litres (improves the drying process of packaged instruments)
6543222	Nitrarack 22 litres (improves the drying process of packaged instruments)





HYGIENE / WATER TREATMENT SYSTEMS

NitraDem Direct Connect

The fully automatic water treatment system

NitraDem Direct Connect provides high-quality treated water ($\leq 3\mu\text{s}$), which is required for the DAC Universal and other autoclaves. The majority of standard reprocessing systems do not guarantee a constant flow or required return flow protection that can meet this requirement. NitraDem Direct Connect is a highly efficient water treatment system that works fully automatically and complies with the European standard EN 1717 that allows a direct connection between water supply and autoclaves.

Three water outlets

In order to avoid cycle interruptions due to poor water quality, we recommend the NitraDem Direct Connect water treatment system. It features three water outlets from which demineralised water is available at a pressure of 5-6 bar.

- Water outlets 1 and 2 are used to connect hygiene systems without a water suction pump, e.g. water pistol or DAC Universal
- At outlet 3, a hygiene system can be optionally connected with or without a water suction pump

The system is not recommended for connection to cleaning and disinfection devices.

Constant monitoring

The NitraDem Direct Connect continuously monitors the quality of the demineralised water to guarantee you the best possible working conditions for your DAC Universal and other autoclaves. This prolongs the service life of the sterilisation devices and instruments and reduces repair costs.

Ease of use

The NitraDem Direct Connect guarantees a quick, simple and constant supply of water to your hygiene devices and allows the practice staff to concentrate on other more important tasks. The easy-to-replace NitraDem filter functions according to the ion-exchange principle.

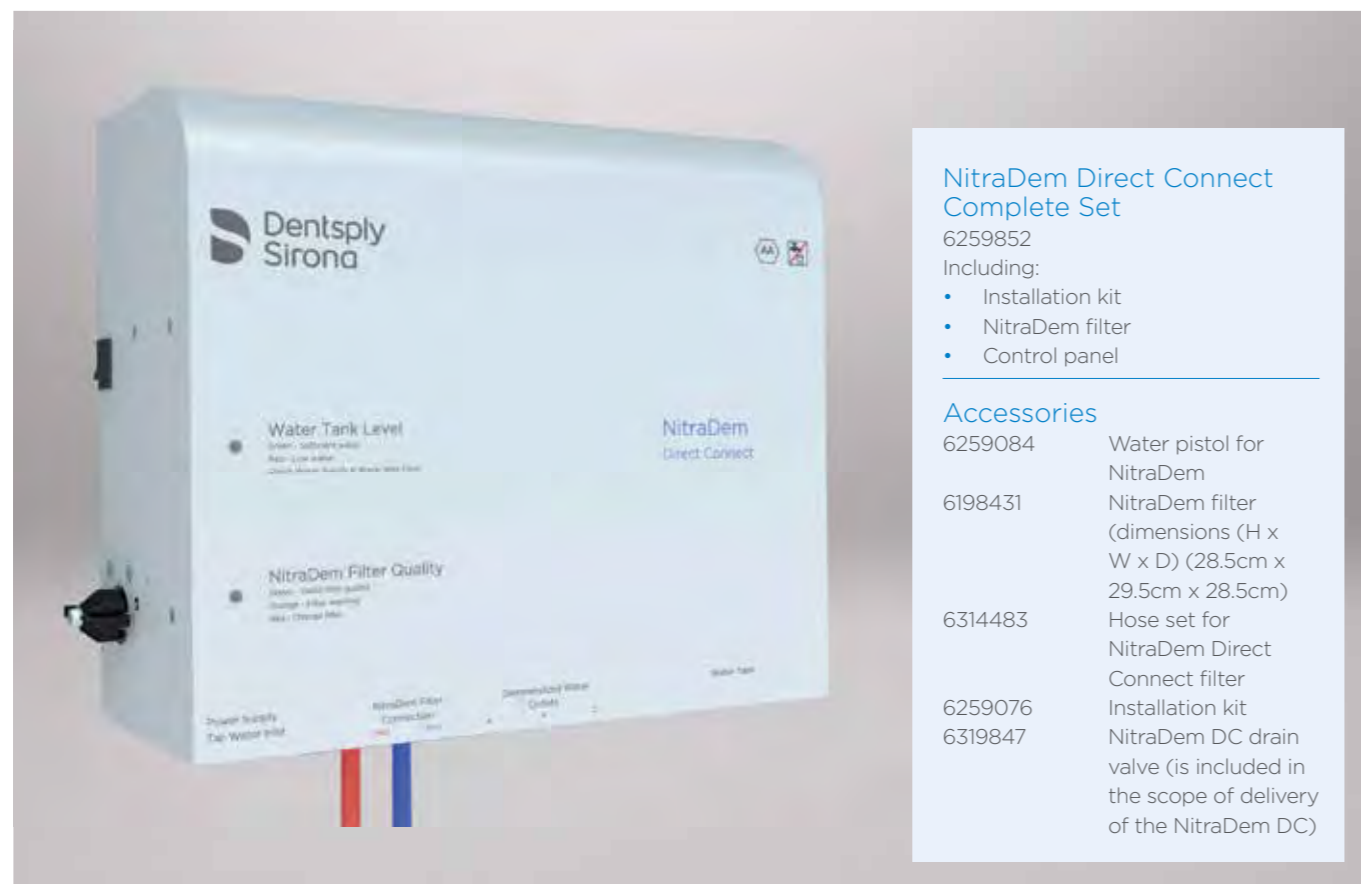

HYGIENE / SEALING DEVICES

SiroSeal Premium and SiroSeal Professional

Seals with the best possible level of safety

The SiroSeal bar sealing devices complement the 'hygiene and sterilisation chain' by facilitating the packaging of surgical instruments in a safer and quicker way before the sterilisation process. This means that autoclaved instruments remain protected until the surgical procedure. SiroSeal is available in two variants: SiroSeal Premium and SiroSeal Professional.

SiroSeal Premium

The sealing process is reproducible and can be validated with SiroSeal Premium. Outstanding ease of use, performance and convenient options for process documentation, make SiroSeal Premium the new benchmark for sealing devices of this class. And all with an unbeatable heat-up time of 90 seconds and a sealing time of just three seconds.

Packages process can be validated

- Legal safety through compliance with requirements of standard EN 11607-2
- Monitoring of three process parameters: temperature, contact pressure and sealing time
- 10mm sealed seam

Saves time and energy

- Heats up in just 90 seconds
- Seals in just 3 seconds
- Simple user administration

Comfortable

- Simple and seamless documentation (e.g. USB pen drive or directly via PC)
- LCD display and 4 intuitive control keys
- 2 USB ports

SiroSeal Professional

Safe, proven and high performing: SiroSeal Professional is a stable, high-performance bar sealing device. The visual and acoustic indicator that displays, for example, operational readiness after a short warm-up time of about two minutes, is especially noteworthy.

Safe

- Optical and acoustic control signal
- Internal processor
- 10mm sealed seam

Reliable

- High quality
- Technology tried and tested thousands of times

Powerful

- Approx. 2 minutes heat-up time
- Continuous sealing - no interruptions



HYGIENE / **PRINTER**

MELAprint 44

Printer for DAC Professional/
DAC Professional Plus and DAC
Premium/DAC Premium Plus



MELAprint 44 Printer
6668441



DAC Universal

Hazards turned harmless.

You think you will never win the fight against germs but Dentsply Sirona turns hygiene risks into manageable maintenance. With the DAC Universal you'll benefit from an automated and quick way of cleaning, lubricating and disinfecting dental instruments. The short processing time makes it possible to comply with hygiene requirements by simply pressing a button. Your patients and your team can fully rely on our comprehensive protection against hazards.

Find out more at dentsplysirona.com

THE DENTAL
SOLUTIONS
COMPANY™

 **Dentsply
Sirona**

Preventive Dental Care Matters

Preventive is a continuum of care. It involves a careful series of steps, clinically-proven and trusted products, patient self-care education, continual learning, and people - all working together - to promote a lifetime of oral health. Our comprehensive range of preventive solutions and support empower dental professionals to deliver better, safer and faster preventive care. It's all part of our ongoing commitment to prevent diseases, improve oral health, and deliver the best possible experience and outcomes for clinicians and patients.

Solutions that make a difference every day and for years to come:

Our innovative solutions are making it possible to diagnose a wider range of potential problems earlier and with greater accuracy. At the same time, the scaling, polishing, and treatment solutions we've pioneered help raise the standard of care by making each visit as effective as it is comfortable. Only by helping create the best possible patient experience can we expect them to keep coming back to achieve the frequency and regularity of hygiene visit that is the essence of preventive care.



Contents



Infection Control

Air/Water Syringe Products

Sani-Tip®	123
FASTips®	124

Face Masks

Com-Fit®	124
----------	-----

Barrier Protection

Disposa-Shield®	125
-----------------	-----

Sterilisation Packs

Assure Plus®	126
--------------	-----

Evacuation System

Purevac® HVE	127
--------------	-----

Scaling

Ultrasonic Scaling Systems

Cavitron® 300	129
Cavitron® Jet Plus™ with Tap-On™ Technology	130
Cavitron® Plus™ with Tap-On™ Technology	131
Cavitron® Select™ SPST™	132

Air Polishing System

Cavitron® Prophy-Jet®	133
-----------------------	-----

Dispensing System

Cavitron® DualSelect®	133
-----------------------	-----

Detachable Sterilisable Handpieces

Cavitron® Steri-Mate® 360°	134
Cavitron® Steri-Mate®	134
Cavitron® Jet-Mate®	134

Ultrasonic Scaling Inserts

Cavitron® Ultrasonic Inserts	135
------------------------------	-----

Polishing

Prophylaxis Pastes

Nupro® Prophylaxis Pastes	138
---------------------------	-----

Polishing Accessories

Disposable Prophy Cups and Brushes	139
------------------------------------	-----

Treatments

Fluorides and Desensitizers

Nupro® Fluorides Oral Solution & Topical Gels	139
---	-----

Sealants

Delton®	140
---------	-----



INFECTION CONTROL / AIR/WATER SYRINGE PRODUCTS

Sani-Tip®

A 'single-use' sterilization option for metal 3-in-1 syringe tips

The disposable tip reduces the potential for cross-contamination via air/water syringe and delivers precise separation of air and water for consistent dry air. Ideal for sealant applications and restorative procedures.

- Clear disposable tip
- Innovative patented design
- Consistent dry air
- Smooth exterior and polished ends
- Rigid – provides secure retraction
- Latex free



Sani-Tip® Disposable Air/Water Syringe Tips

122211 Sani-Tip® Disposable Tips, Tip Length = 75mm
(250x Tips and 250x Sani-Shield® Sleeves per pack)

Sani-Shield® Air/Water Syringe Sleeves

Prevent cross-contamination by covering your handpiece with a disposable Sani-Shield® protector.

130010 Sani-Shield® Air/Water Syringe Sleeves (250x per pack)

Sani-Tip® Air/Water Syringe Conversion Kits

Includes: 10x Sani-Tip® Tips, 1x Adaptor Assembly, 1x Hex Key, Installation Instructions



Sani-Tip® conversion kit reference guide

 A-1 122220N S1 ADEC Style Syringes	 AN-122400N S1 ANTHOS Cefla Syringes	 B-1 122290N S1 BELMONT Takara Syringes	 C-1 122370N S1 CASTELLINI Cleanthree and Cleanwarm Syringes	 C-2 122371N S1 CASTELLINI Multiteril Syringes	 C-3 122372N S1 CASTELLINI Multiteril II (Puma Unit) Syringes
 D-1 122240N S1 DEN-TAL-EZ Syringes	 E-1 122230N S1 ENGL/MARCO Syringes	 F-1 122260N S1 FARO Syringes Pre-1991	 F-3 122263N S1 FARO SR903 / SR906 Syringes	 K-3 122275N S1 KAVO 573 0620/573 0630 Syringes (Systematica no optics)	 K-4 122276N S1 KAVO 773 0500 / 773 0510 Estetica Syringes
 L-1 122320N S1 LUZZANI	 L-2 122325N S1 LUZZANI Minimatic Syringes (Black Plastic)	 L-3 122326N S1 LUZZANI Minilight, Minimatic, Minimatic Anthos A4 Syringes	 MC-1 122340N S1 MICRON / NSK Syringes	 MC-1 122340N S1 YOSHIDA 250 Model Syringes	 M-1 122330N S1 MORITA WS9 Syringes (silver)
 M-1 122330N S1 MORITA WS10 Syringes (reddish brown)	 M-2 122336N S1 MORITA WS66 / WS88 / WS89 / WS90 Syringes	 M-4 122332N S1 MORITA WS12 Syringes (dark brown autoclavable plastic body)	 P-1 122280N S1 PRESS RING DCI Syringes	 S-1 122250N S1 SIEMANS Sprayvit 4000 / 4000L / 4000E Syringes	 SL-2 122251N S1 SIEMENS Sirona Syringes



INFECTION CONTROL / AIR/WATER SYRINGE PRODUCTS

FASTips®

Adaptorless

- Completely interchangeable with metal tips meaning no adaptors or conversion kits are needed
- Durable, all plastic construction
- Separate air and water channels help minimise air and water crossover
- Completely disposable - designed to reduce potential for cross-contamination



122503 FASTips® Disposable Tips (250 per pack)



INFECTION CONTROL / FACE MASKS

Com-Fit®

Facial protection masks to meet the needs of any office

High filtration

97-99.9% filtration at 0.1 micron, providing protection against bacteria, viruses and other microscopic particles.

Breathability

Com-Fit® masks keep you cool, allow you to breathe with minimal moisture, and are more comfortable without sacrificing protection.

Non-irritating

Com-Fit® masks contain hypoallergenic and latex free components which will not irritate the skin. The ear loops and ties are ultra-soft and ultrasonically bound for your comfort.

Com-Fit Plush®

20352	Com-Fit Plush® Face Mask With Soft Earloop, ASTM Level 1 (40 per pack)
20353	Com-Fit Plush® Face Mask With Soft Earloop, ASTM Level 2 (40 per pack)
20354	Com-Fit Plush® Face Mask With Soft Earloop, ASTM Level 3 (40 per pack)
20355	Com-Fit Plush® Natural Fit - ASTM 1 (40 per pack)
20356	Com-Fit Plush® Natural Fit - ASTM 2 (40 per pack)
20357	Com-Fit Plush® Natural Fit - ASTM 3 (40 per pack)



Com-Fit®

20324	Com-Fit® Fluid Resistant Masks Ear Loop Blue (50 per pack)
20325	Com-Fit® Fluid Resistant Masks Ear Loop Pink (50 per pack)
20326	Com-Fit® Super High Filtration Masks Ear Loop Blue ASTM 1 (40 per pack)
20328	Com-Fit® Super High Filtration w/Shield, Ear Loop ASTM 1 (25 per pack)
20336	Com-Fit® Super High Filtration Masks Tie-On Blue ASTM 1 (40 per pack)
20340	Com-Fit® Easy Breathe Ear Loop Blue (40 per pack)
20342	Com-Fit® Easy Breathe Tie-On Blue (40 per pack)
20346	Com-Fit® Super Sensitive Ear Loop White ASTM 1 (50 per pack)
20344	Com-Fit® Super Sensitive Tie-On White ASTM 1 (50 per pack)
20350	Com-Fit® Groovy Ear Loop (40 per pack)



INFECTION CONTROL / BARRIER PROTECTION

Disposa-Shield®

Disposable covers for high-touch dental equipment and surfaces



Disposa-Shield® ensures that you can benefit from a 'state of the art' system to provide the solution to your cross infection needs, offering barrier protection to those awkward handpiece assemblies.

- Shaped for better fit and to reduce excess material
- Designed to help prevent cross-contamination
- Provides patient reassurance and protection
- Saves clean-up time between patients
- Easy on - easy off
- Easy to dispense packaging
- Protects expensive equipment

"Protect light and chair hand controls with disposable impervious coverings and change between patients."

Sourced from the BDA Advice Sheet A12.



A88006	Disposa-Shield® Low Speed Long Handpiece Cover (500 per box) New design to fit a Midwest® Handpiece - 1/4" wider. Dimensions: 7.75" x 1.25"	6509002	Disposa-Shield® Infection Control Barrier For Airmotor and Air/Water Syringe 2 (44.5cm x 5.5cm) (250 per pack)
A88007	Disposa-Shield® Universal Air/Water Syringe Cover (500 per box) Dimensions: 6.625" x 2.25"	6509003	Disposa-Shield® Infection Control Barrier For Tubing, Turbine and Cavitron Head 3 (44.5cm x 4.5 cm) (250 per pack)
65090001	Disposa-Shield® Infection Control Barrier For Light Handles and Control Panels 1 (15cm x 10cm) (1000 per pack)	65090004	Disposa-Shield® Infection Control Barrier For Headrests and X-Ray Heads 4 (30cm x 23.5cm) (250 per pack)

INFECTION CONTROL / **STERILISATION POUCHES**

Assure Plus®

Self-sealing sterilisation pouches

Assure Plus® are peel-off, self-sealing sterilisation pouches. The peel-off internal indicator confirms heat penetration inside the pouch and affixes to the patient file for a permanent sterilisation record. There are dual heat sterilisation internal and external indicators, and the solid double seal gives four seals of protection against separation, puncture and waste. Pouches are aqua-tinted, see-through 4-ply film.

Item Number	Description	Pack size
83000	Assure Plus® 89x165mm	200
83003	Assure Plus® 70x254mm	200
83005	Assure Plus® 89x254mm	200
83010	Assure Plus® 133x279mm	200
83015	Assure Plus® 191x356mm	200
83020	Assure Plus® 254x406mm	200
83025	Assure Plus® 305x457mm	100

INFECTION CONTROL / **EVACUATION SYSTEM**

Purevac® HVE Evacuation System

High Volume Evacuation + Mirror in a Single Instrument

The Purevac® HVE System is designed to provide oral high-volume evacuation, visualization, illumination, and retraction during dental procedures. It consists of the HVE Mirror Tip which is a high-volume evacuation tip with built-in dental mirror. This enables a one-handed approach to evacuate the patient's oral cavity of aerosols, splatter, fluid, and debris, while also providing visibility and illumination to the treatment area. An HVE Hose Adapter is available and consists of a flexible and lightweight HVE hose connected to a 360-degree swivel for the HVE Mirror Tip.

Providing visibility and suction all in one hand

- Increases Efficiency
- According to clinicians in a user study.

Better Visibility

- Fog-free mirror with continuous suction of fluids and debris.

Greater Fluid Reduction

- 135% more than a low-volume saliva ejector.

Easier Maneuverability

- 69% lighter and 130% more flexible than a standard HVE hose.
- 5-foot, kink-resistant hose with 360° swivel connection for HVE Mirror Tip.

Reduced Noise

- 14% less than a standard HVE tip.
- 5% less than a low-volume saliva ejector.



11000	Purevac® HVE System with Mirror Tips and Hose Adapter
CD1011V	Purevac® HVE Mirror Tips 1 FS Rhodium and 1 Ultra FS
CD1033	Purevac® HVE Mirror Tips 3 FS Rhodium and 3 Ultra FS
CD2006	Purevac® HVE Mirror Tips 6 FS Rhodium
CD2012	Purevac® HVE Mirror Tips 12 FS Rhodium
CD2024	Purevac® HVE Mirror Tips 24 FS Rhodium

In a research study, **HVE removed 90% more aerosols** during ultrasonic scaling compared to a low-volume saliva ejector.¹

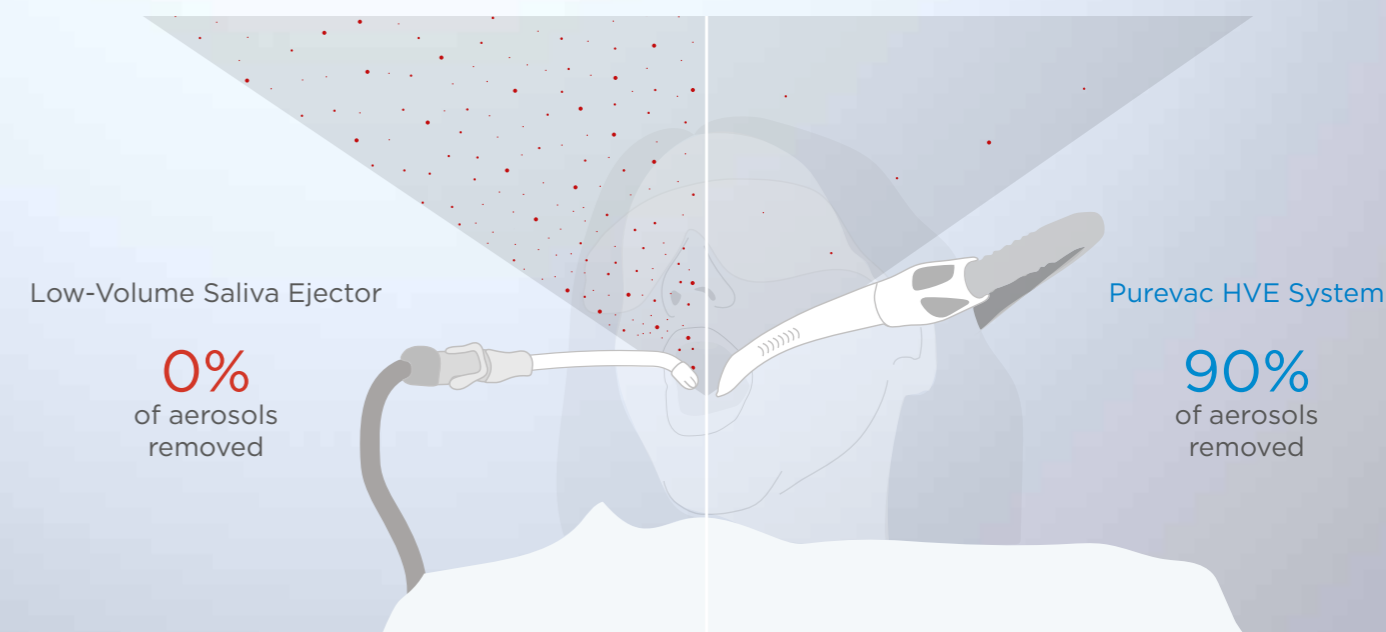

¹ Jacks MJ: A laboratory comparison of evacuation devices on aerosol reduction. J Dent Hig 2002, 76, 202-206.



SCALING / ULTRASONIC SCALING EQUIPMENT

Cavitron® Table-Top Systems

There's only one Cavitron®

For over five decades, dental professionals have preferred the clinical benefits and labour-saving advantages inherent in Cavitron® ultrasonic scalers. Clinical studies and independent research have proven that no other method of supra- and subgingival calculus removal can surpass the speed, efficiency, and versatility of ultrasonic scaling.

Dentsply Sirona offers you a range of Cavitron® ultrasonic scalers (30K and 25K) so you can choose the one that best suits your needs. All of our 30K units are powered by Sustained Performance System™ technology (SPS™) which offers a constant balance between scaling efficiency and patient comfort by maintaining clinical power when the insert tip encounters tenacious deposits. This allows the clinician to effectively scale even at a decreased/lower power setting. The SPS™ technology is further advanced by the 'Blue Zone™' which provides more comfort for the patient.

Our newest innovation Cavitron® 300, keeps the trusted performance of our Cavitron® systems, but the reimaged unit now has touch screen technology to complement the digital age. Alongside this, the Tap-On™ Technology activates scaling or air polishing with a single tap of the foot pedal, allowing the foot to rest during the procedure. The maneuverability of the Cavitron® Steri-Mate 360° fully rotating handpiece allows for adjustable hand positioning, flowing movement and easy access within the anterior and posterior of the oral cavity, and the featherweight handpiece cable is designed to provide ergonomic benefits by reducing cable drag. These improved benefits make Cavitron® 300 our most innovative ultrasonic scaling system yet.

Which Cavitron® table-top system is best for my practice?

	Cavitron® 300 (30K)	Cavitron® Jet Plus™ (30K)	Cavitron® Plus (30K)	Cavitron® Select SPS (30K)	Cavitron® Prophy-Jet
Scaling Capabilities	✓	✓	✓	✓	
Air Polishing Capabilities		✓			✓
Prophy Mode Auto Cycles		✓			✓
Wireless Tap-On™ Technology Foot Pedal	✓	✓	✓		
Rinse Function	✓	✓	✓		
Purge Mode	✓	✓	✓		
Pivoting Handpiece Cable	✓	✓	✓	✓	
Water Control on Handpiece	✓	✓	✓	✓	
Hands-Free Boost Mode	✓	✓	✓	✓	
Intelligent Feedback Control (SPS™ Technology)	✓	✓	✓	✓	
Steri-Mate®/Jet-Mate® Autoclavable Detachable Handpiece	✓	✓	✓	✓	
Steri-Mate® 360 Autoclavable Detachable Swivel Handpiece	✓				
Touch Screen Interface	✓				
Memory Presets	✓				
Featherweight Detachable Handpiece Cord	✓				
Water Filter Indication Light	✓				
Reservoir/Bottle System (optional w/o Reservoir)				✓	
Warranty	3 years	2 years	2 years	2 years	2 years

Try the...

Cavitron® Table-Top System of your choice

With Dentsply Sirona's impressive range of scaling inserts, giving you the choice depending on the clinical case presented to you.



SCALING / ULTRASONIC SCALER SYSTEM

Cavitron® 300

Our most efficient Cavitron® System ever

The Cavitron® 300 Series has the latest in user-friendly controls, providing you an improved scaling experience. The digital touch screen technology provides an easy-to-use interface. The wireless Cavitron® Tap-On™ Technology foot pedal is designed to reduce leg and ankle discomfort.

- Wireless Tap-On™ Technology foot pedal
- Low profile design for improved space management
- Exclusive Steri-Mate® 360 fully rotating, detachable and autoclavable handpiece
- Touchscreen interface
- Lightweight handpiece cable
- Memory presets
- Water filter indication light
- Most efficient system ever, producing less heat, requiring less water for better patient comfort
- Quieter than other ultrasonic scaling systems for patient comfort



Cavitron® 300 Series Ultrasonic Scaling System Unit - 220/240V-EU

8270311

Includes:

- 1x Cavitron® 300 Series Ultrasonic Scaling System Unit
- 1x Cavitron® Steri-Mate® 360 Handpiece
- 3-Year Warranty

Try me with...

Purevac® HVE System

For a simplified scaling experience — less aerosols, less water, featherweight cables, 360 degrees of rotation, fog-free mirror and high-volume evacuation. This system has single-handedly transformed the ultrasonic scaling procedure.





SCALING / ULTRASONIC SCALER AND AIR POLISHING SYSTEM

Cavitron® Jet Plus™ with Tap-On™ Technology

A system of solutions for practical, preventive dentistry

Cavitron® Jet Plus™ with Tap-On™ Technology is a 2-in-1 system, providing premium ultrasonic scaling and polishing comfort. This system supports air polishing, ultrasonic periodontal debridement with turbo boost, and deep pocket ultrasonic lavage delivering medicament.

Improved hygienist comfort

- Nearly one-third of dental health professionals cite musculoskeletal disorders as the reason for early retirement¹
- Tap-On™ Technology activates scaling or air polishing with a single tap of the wireless foot pedal, allowing the foot to rest during the procedure
- Prophy mode auto cycles automatically alternate between air polish and rinse without the need to touch the pedal

Enhanced efficiency

- Additional power options include single-push turbo mode for up to 25% greater power and hands-free boost activation by pressing the pedal to the floor
- Finer water control allows for precise and convenient adjustment of lavage on the handpiece to the preferred setting

PLUS all the benefits you have come to expect from Cavitron® Systems

- Extended 'Blue Zone' Power range – for increased patient comfort when scaling sub-gingivally
- Fully autoclaveable Steri-Mate® swivel handpiece to help manage infection control
- Single-push rinse and purge modes
- Illuminated diagnostic display informing the user of the units status at a glance
- Rinse setting to flush out periodontal pockets and antibacterial lavage
- SPS™ Technology (Sustained Performance System™)

Cavitron® Jet Plus™ with Tap-On™ Technology 30K, 230V EU, + Free Cavitron® Insert FSI SLI 1000

8187502

- 1x Cavitron® Jet Plus™ Unit
- 1x Jet-Mate® Handpiece
- 1x Wireless Foot Control with Tap-On™ Technology
- 1x 30K FSI SlimLine® 1000 Triple Bend
- 1x Bottle of Jet-Fresh® Prophy Powder
- 1x Bottle of Prophy-Jet® Prophy Powder
- Insert Pocket Guide
- Wear Indicator
- (Batteries and cable included)



Accessories

- | | |
|--------|--|
| 130002 | Cavitron® Prophy-Jet® Prophy Powder (13 oz. bottle)
Sodium bicarbonate powder for use in Cavitron® Jet Plus™ and Prophy Jet® Systems. Refreshing mint flavor. |
| 130203 | Cavitron® Jet-Fresh® Prophy Powder (33oz. bottle)
Aluminum trihydroxide powder (Na-free) for use in Cavitron® Jet Plus™ and Prophy Jet Systems. Refreshing mint flavor. |



SCALING / ULTRASONIC SCALER SYSTEM

Cavitron® Plus™ with Tap-On™ Technology

Provides premium scaling comfort

Cavitron® Plus™ with Tap-On™ Technology is an ultrasonic scaler system with the following:

- Tap-On™ Technology is designed to reduce leg and ankle discomfort associated with continued foot pedal usage – A single tap activates scaling, allowing you to rest your foot during the procedure
- 360° wireless foot control provides ease of operation and mobility
- Additional power option include single-push turbo mode for up to 25% greater power and hands-free boost activation by pressing the pedal to the floor
- Lavage control conveniently located on the handpiece allows easy adjusting without turning from the patient
- SPS™ Technology (Sustained Performance System) automatically adjusts system power to maintain tip stroke regardless of clinical load and conditions
- Extended Low Power Range, BlueZone™, designed for improved patient comfort
- Autoclavable handpiece provides assurance against cross-contamination
- Single-push rinse and purge modes enhances efficiency
- Accepts 30K Inserts

Cavitron® Plus™ with Tap-On™ Technology 30K, 230V EU, + Free Cavitron® Insert FSI SLI 1000 8184002

- 1x Cavitron® Plus Unit
- 1x Steri-Mate® Handpiece
- 1x Wireless Foot Control with Tap-On™ Technology
- 1x 30K FSI® SlimLine® 1000 Triple Bend
- Insert Pocket Guide
- Wear Indicator
- (Batteries and Cables Included)





SCALING / ULTRASONIC SCALER SYSTEM

Cavitron® Select™ SPS™

Designed to provide clinical efficiency and increased clinical productivity

The Cavitron® Select™ SPS™ ultrasonic scaler is a compact, portable unit that incorporates a self-contained reservoir with the unique Sustained Performance System (SPS™) technology. This practical design delivers 30KHz oscillating scaling power without the need for a dedicated water line - all you need is a power supply. The Cavitron® Select™ SPS™ ultrasonic scaler blends the benefits of plug & play portability, with the performance needed by the dedicated periodontal provider or prophylaxis room.

- Steri-Mate® autoclave reliability (750+ cycles)
- Quick-connect instrument inserts
- Hands-free power boost
- 500ml medicament dispenser
- Portability with plug & play installation

Cavitron® Select™ SPS™

81313E Cavitron® Select™ SPS™ Scaler (with Reservoir), 230V EU, + Free Cavitron® Insert 30K FSI -1000

81307E Cavitron® Select™ SPS™ Scaler (without Reservoir), 230V EU, + Free Cavitron® Insert 30K FSI -1000

Cavitron® Select™

Cavitron® Select™ was the first compact, portable Cavitron® unit with 25kHz technology and a self-contained water reservoir. You can scale with this unit virtually anywhere you have a power source. This is what makes the Cavitron® Select™ so easy to use.

90116E Cavitron® Select™ Scaler (with Reservoir), 230V EU, + Free Cavitron® Insert 25K FSI -1000

90112E Cavitron® Select™ Scaler (without Reservoir), 230V EU, + Free Cavitron® Insert 25K FSI -1000

Cavitron® Select™ Reservoir Pump and Reservoir Pump

- Allows Cavitron® Select™ ultrasonic scalers to operate as a self-contained system, eliminating the need for external water hookup
- Refillable bottle. No need to disassemble the bottle from the Select™ Reservoir

90147 Reservoir Pump and Reservoir Bottle Upgrade Kit for Cavitron® Select™ SPS™ or Select™

90148 Autoclavable Reservoir Bottle for the Cavitron® Select™ SPS™ or Select™



SCALING / AIR POLISHING SYSTEM

Cavitron® Propphy-Jet®

Fast, easy operation and for greater productivity

The Cavitron® Propphy-Jet® air polishing system removes stubborn stains, plaque and soft debris more efficiently than either rubber cup polishing or hand cures. The Cavitron® Propphy-Jet® can be used before sealants, bonding orthodontic fixtures and during periodontal surgery.



8195002 Cavitron® Propphy-Jet®, 230V



SCALING / DISPENSING SYSTEM

Cavitron® DualSelect®

Closed water source or medicaments

Cavitron® DualSelect® dispensing system offers the choice of scaling and polishing with either water or medicaments. With the addition of this dispensing system, clinicians have an option of using external water or creating an immediate closed water system for ultrasonic scaling, periodontal debridement and air polishing procedures.

- Fluid selection is easily made. Choose the dispensing bottle desired by rotating the selector handle to position "A" or "B"; select "H2O" for external dental office water supply. When needed, medicaments can be delivered for site specific work.
- Closed Water Line Option is available by utilising water from the dispenser bottles instead of external dental office water
- Infection control procedures are easily accomplished by flushing the system weekly using the designated disinfectant bottle.

80528 Cavitron® DualSelect® Dispensing System

- 1x Cavitron® DualSelect®
- 2x 500ml Dispensing Bottles
- 1x Disinfection Bottle

80529 Cavitron® DualSelect® Accessory Pack (2 bottles with accessories)

80530 Cavitron® DualSelect® Disinfectant Bottle



SCALING / DETACHABLE STERILISABLE HANDPIECES

Cavitron® Steri-Mate® 360°

Feel the difference of effortless rotation

The Cavitron® Steri-Mate® 360° handpiece is compatible with the Cavitron® 300 scaling system and offers features that provide a new scaling experience.

- The maneuverability of the Cavitron® Steri-Mate 360° fully rotating handpiece allows for adjustable hand positioning, flowing movement and easy access within the anterior and the posterior of the oral cavity
- The detachable and autoclavable handpiece provides the highest assurance of control against cross-contamination
- The featherweight handpiece cable is designed to provide ergonomic benefits by reducing cable drag
- Creates a tactile sensitivity similar to that of hand scaling

8183201	Cavitron® Steri-Mate® 360° Detachable Sterilisable Handpiece for Cavitron® 300 System (1 per pack)
8183203	Cavitron® Steri-Mate® 360° Detachable Sterilisable Handpiece Cavitron® 300 System (3 per pack)

SCALING / DETACHABLE STERILISABLE HANDPIECES

Cavitron® Steri-Mate®

Allows for free flowing movement

- Fully rotating handpiece allows for free flowing movement of an ultrasonic insert within the oral cavity
- The detachable and autoclavable handpiece provides the highest assurance of control against cross-contamination
- Allows users to keep their wrist in a neutral position to provide a comfortable user experience

Cavitron® Steri-Mate® Handpieces

78688	Cavitron® Steri-Mate® Detachable Sterilisable Handpiece - Black (1 per pack)
78703	Cavitron® Steri-Mate® Detachable Sterilisable Handpiece - Black (3 per pack)
8183001	Cavitron® Steri-Mate® Detachable Sterilisable Handpiece - Grey (1 per pack)

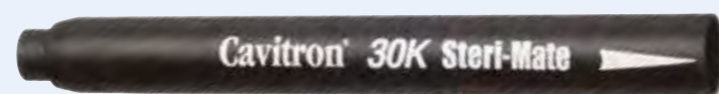
SCALING / DETACHABLE STERILISABLE HANDPIECES

Cavitron® Jet-Mate®

Ergonomic handle with 300° rotation

- Cavitron® Jet-Mate® Handpiece is detachable and autoclavable to reduce cross contamination and enhance infection control
- The handpiece cable with swivel allows 300° rotation designed to provide ergonomic benefits by reducing cable drag



8170201	Cavitron® Jet-Mate® Handpiece (1 per pack)
8170203	Cavitron® Jet-Mate® Handpiece (3 per pack)

SCALING / ULTRASONIC SCALING INSERTS

Cavitron® Ultrasonic Inserts

Small things, big difference

In ultrasonic scaling, one insert is not enough. That's why the Cavitron® family of inserts offers a broad selection of ultrasonic scaling inserts to fit the needs of your practice. Just like with hand scaling, some inserts are built for removing certain levels of deposit, while others are designed for working around specific types of tooth anatomy.

For Light to Moderate Deposit Removal
Cavitron® Thinsert® 30K Ultrasonic Insert

- 47% thinner than Focused Spray® Slimline® 10S insert
- Provides access in difficult areas including misalignments, interproximal surfaces, and areas of tight tissues, without loss of tactile sensation
- Unique backbend design for easier access and easy adaptation
- Can be used with low to high power



Item Number	Description	Colour Code/Power Setting	Use
81551	Cavitron® Thinsert® 30K Ultrasonic Insert	Lavender Grip/ Low-High	For Light to Moderate Calculus and Deplaquing

Cavitron® Slimline® Ultrasonic Insert Series - 30K and 25kHz

- Focused Spray® technology water delivery designed to deliver targeted lavage for increased clinician visibility and greater patient comfort
- 30% thinner than Powerline® ultrasonic inserts, and the design provides improved subgingival access
- Cavitron® Slimline® right and left ultrasonic inserts provide maximum access and adaptability to root anatomy, including concavities and furcations



Item Number	Description	Colour Code/Power Setting	Use
80395	Cavitron® Slimline® 10S 30K Ultrasonic Insert	Dark Green Grip/ Low-Medium, except for 1000	For Fine Periodontal Debridement
80396	Cavitron® Slimline® 10L 30K Ultrasonic Insert		
80397	Cavitron® Slimline® 10R 30K Ultrasonic Insert		
81570	Cavitron® Slimline® 1000 30K Ultrasonic Insert		
80399	Cavitron® Slimline® 3 Pack (10S/10R/10L) 30K Ultrasonic Insert		
80401	Cavitron® Slimline® 2 Pack (10R/10L) 30K Ultrasonic Insert		
82005	Cavitron® Slimline® 10S Fitgrip® 30K Ultrasonic Insert		
82006	Cavitron® Slimline® 10L Fitgrip® 30K Ultrasonic Insert		
82007	Cavitron® Slimline® 10R Fitgrip® 30K Ultrasonic Insert	Light Green Grip/Low-Medium, except for 1000	
82008	Cavitron® Slimline® 1000 Fitgrip® 30K Ultrasonic Insert		
80392	Cavitron® Slimline® 10S 25K Ultrasonic Insert		
80393	Cavitron® Slimline® 10L 25K Ultrasonic Insert		
80394	Cavitron® Slimline® 10R 25K Ultrasonic Insert		
81569	Cavitron® Slimline® 1000 25K Ultrasonic Insert		
80398	Cavitron® Slimline® 3 Pack (10S/10R/10L) 25K Ultrasonic Inserts		
80400	Cavitron® Slimline® 2 Pack (10R/10L) 25K Ultrasonic Inserts		



SCALING / ULTRASONIC SCALING INSERTS

Cavitron® Ultrasonic Inserts

For Moderate to Heavy Deposit Removal

Cavitron® Powerline® Ultrasonic Insert Series - 30K and 25kHz

- Focused Spray® technology water delivery designed to deliver targeted lavage for increased clinician visibility and greater patient comfort
- Specially designed for removing heavier deposits
- Patented internal water delivery system delivers water directly to the insert tip and “focuses” the water where it’s needed most
- Cavitron® Powerline® 3 - Flat beavertail tip designed for use on calculus bridges and removal of heavy staining
- Cavitron® Powerline® 1000 - For moderate to heavy tenacious calculus removal



Item Number	Description	Colour Code/Power Setting	Use
80797	Cavitron® Powerline® 3 30K Ultrasonic Insert	Dark Blue Grip/ Low-High	For Moderate to Heavy Deposit Removal
80294	Cavitron® Powerline® 10 30K Ultrasonic Insert		
80798	Cavitron® Powerline® 100 30K Ultrasonic Insert		
80799	Cavitron® Powerline® 1000 30K Ultrasonic Insert		
80794	Cavitron® Powerline® 3 25K Ultrasonic Insert	Light Blue Grip/ Low-High	
80293	Cavitron® Powerline® 10 25K Ultrasonic Insert		
80795	Cavitron® Powerline® 100 25K Ultrasonic Insert		
80796	Cavitron® Powerline® 1000 25K Ultrasonic Insert		
82001	Cavitron® Powerline® 3 Fitgrip® 30K Ultrasonic Insert		
82002	Cavitron® Powerline® 10 Fitgrip® 30K Ultrasonic Insert		
82003	Cavitron® Powerline® 100 Fitgrip® 30K Ultrasonic Insert		
82004	Cavitron® Powerline® 1000 Fitgrip® 30K Ultrasonic Insert		

For Implants

Cavitron® SofTip® Ultrasonic Implant Insert

- The Cavitron® SofTip® Implant Insert removes plaque and calculus around titanium implants and abutments, allowing you to save time during an implant maintenance procedure and providing the convenience of lavage delivery. The Cavitron® SofTip® Implant insert is only used with a SofTip® disposable prophylaxis tip attached. The SofTip® disposable prophylaxis tip is a single-use, plastic tip that is safe for implant maintenance. Low power only.
- Designed to gently remove light to moderate plaque and calculus without damaging implant titanium abutment surfaces
- Provides the benefit of ultrasonic lavage during implant maintenance procedures

Item Number	Description	Colour Code	Use
90411	Cavitron® SofTip® Implant 30K Ultrasonic Insert (Must be used with SofTip® Disposable Prophylaxis Tip) Includes: 1x Tip Tool (Wrench), 15x SofTip® Disposable Prophylaxis Tips	Dark Yellow Grip	For Implants

Accessories

- 380059 Cavitron® SofTip® Disposable Prophylaxis Tips (100 per pack)
Designed to work with the Cavitron® SofTip® Ultrasonic Implant Insert and the Midwest Quixonic® Sonic Scaler using the Quixonic® metal SofTip® base
- 380060 Cavitron® SofTip® Disposable Prophylaxis Tip Removal Wrench (1 per pack)

Try me with...

The Cavitron® unit of your choice

Cavitron® systems lead the competition with innovative features and benefits that enhance the scaling experience. With a legacy of quality and performance, the Cavitron® family of products continues to innovate to meet all of your dental practice needs.



Say Hello

to the Cavitron® 300 Series
Ultrasonic Scaling System

Coming December 2020!



There's only one Cavitron.
Request a demo at dentsplysirona.com/cavitron300

© 2018 Dentsply Sirona Preventive
CAV28-0818-3

THE DENTAL
SOLUTIONS
COMPANY™

 Dentsply
Sirona



POLISHING / PROPHYLAXIS PASTES

Nupro® Prophylaxis Pastes

Gently removes plaque and staining

- An aid for the removal of calculus and endotoxins from the tooth surface through a blend of polishing and cleaning agents used with a prophylaxis procedure
- Excellent stain removal and polishing performance
- Unique proprietary formulation designed to deliver consistent, splatter-free performance
- Gluten-free

Three grits available:

- Fine Grit (Gold) - Light stain removal; amalgam polishing
- Medium Grit (Blue) - Normal cleaning and polishing; light plaque removal
- Coarse Grit (Red) - Heavy stain and plaque removal



Nupro® Prophy Paste Cups

(200x Single Dose Cups, 1x Prophy Grip, 1x Prophy Ring)

Every cup pack of Nupro® also contains the novel Nupro® Prophy Grip, an autoclavable prophy paste holder, which provides effortless and relaxed working. The Prophy Grip can be used with prophy paste in 340g jars or individual cups.

801231	Fine Grit	Orange with FI
801230	Fine Grit	Orange w/o FI
801232	Fine Grit	Mint with FI
801311	Fine Grit	Razzberry with FI
801221	Medium Grit	Orange with FI
801220	Medium Grit	Orange w/o FI
801222	Medium Grit	Mint with FI
801223	Medium Grit	Mint w/o FI
801310	Medium Grit	Razzberry with FI
801211	Coarse Grit	Orange with FI
801210	Coarse Grit	Orange w/o FI
801212	Coarse Grit	Mint with FI
801213	Coarse Grit	Mint w/o FI
801309	Coarse Grit	Razzberry with FI

Nupro® Prophy Paste Jars

(1x 340g Jar, 1x Prophy Grip)

801130	Fine Grit	Orange w/o FI
801122	Medium Grit	Mint with FI
801120	Medium Grit	Orange w/o FI
801112	Coarse Grit	Mint with FI
801110	Coarse Grit	Orange w/o FI



POLISHING / POLISHING ACCESSORIES

Disposable Prophy Cups and Brushes

For polishing and removing stains

Disposable Prophy Cups

(144 per box)
C200030 RA Webbed

Disposable Prophy Brushes

(144 per box)
• Polish and remove stains
C100210 White RA (Right Angle)
C100215 Soft Black RA (Right Angle)

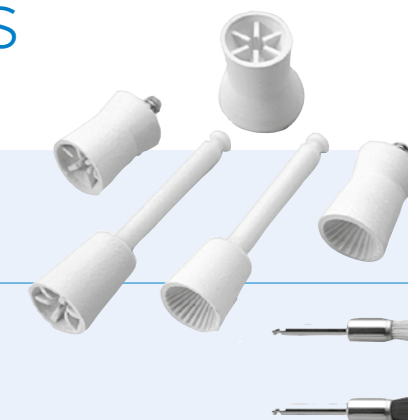

TREATMENTS / FLUORIDES AND DESENSITIZERS

Nupro® Fluorides Oral Solution & Topical Gels

To protect against dental caries

Nupro® Fluoride oral solution and topical gels are available in a 2% neutral sodium fluoride oral solution and a 1.23% acidulated phosphate fluoride topical gel for professional topical application as a fluoride treatment to aid in the protection against dental caries.

- 1 minute treatment (do not exceed 4 minutes)
- 2% neutral sodium fluoride oral solution (0.9% fluoride ion), is safe for patients with porcelain, composite restorations, sealants and xerostomia
- Acidulated phosphate fluoride gel (1.23% fluoride ion), with lower pH
- Convenient 12oz. bottle provides 74 dual-arch treatments per bottle (using 2.5 mL per arch)
- Flip top cap and tamper evident seal

Nupro® Fluorides Acidulated Phosphate Fluoride (APF) Topical Gels

(1x 12oz bottle)
130070 Wild Cherry 1.23% APF Gel
130072 Bubble Gum 1.23% APF Gel

Nupro® Fluorides Neutral Sodium Fluoride (NaF) Oral Solutions

(1x 12oz bottle)
130074 Mandarin Orange 2% Sodium Fluoride Oral Solution
130076 Mint 2% Sodium Fluoride Oral Solution
130078 Apple Cinnamon 2% Sodium Fluoride Oral Solution

Nupro® Fluorides Dual Arch Fluoride Trays

(50x dual arch trays per box)
For use with Nupro® Neutral and APF oral solutions and topical gels during professional application.
• Soft dual arch trays for comfortable application
• Available in 3 sizes for a close anatomical fit

Nupro® White Varnish

(0.4g (pack of 50))
Uniquely formulated varnish for hypersensitivity relief. Nupro® White Varnish releases more than 7 times the amount of Fluoride than the leading varnish brand over a two hour period - and requires a shorter wear time compared to other leading varnish brands.

130222EU Nupro® White Varnish Mint
130210EU Nupro® White Varnish Grape
130213EU Nupro® White Varnish Raspberry

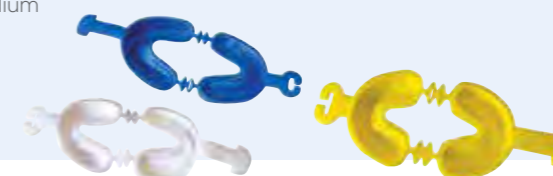



TREATMENTS / SEALANT

Delton®

Pit and fissure sealant

Delton® pit and fissure sealant has a low viscosity ensuring thorough penetration of the fissures and intricate interdental spaces with no air bubbles. Delton® exhibits high bond strength values and provides great caries prophylaxis.

Convincing results: 10 years after applying Delton®, 94.3% of sealed molars were totally non-carious.*

*Data on file.

Delton® Light Cure Direct Delivery System (DDS) Refill Kit
 (50x 0.08ml cartridges)
 2695 Clear
 2696 Opaque
 2000 Autoclavable Applicator (1x per pack)



THE DENTAL SOLUTIONS COMPANY™



Promoting better, safer, faster dental procedures

Purevac® HVE System with Mirror Tips and Hose Adapter



Better

• 135% greater removal of fluids than a low-volume saliva ejector.¹



Safer

• HVE removes 90% more aerosols generated during ultrasonic scaling compared to a low-volume saliva ejector.²



Faster

• High Volume Evacuation + Mirror in a single instrument = visibility and suction all in one hand.

NEW!

High Volume Evacuation and Mirror Tip in a Single Instrument



For more information visit dentsplysirona.com/practiceprotect

1. Data on file
 2. Jacks MJ: A laboratory comparison of evacuation devices on aerosol reduction. J Dent Hig 2002, 76, 202-206.
 © 2018 Dentsply Sirona Preventive INF05-0718-5

The Complete Endodontic Solution

As a leader in endodontics and trusted partner in dental surgery, we shape the future by delivering complete innovative solutions that are best in class. We provide practitioners with more effective and simpler clinical procedures that offer the safest treatment option for patients worldwide.

Our Root to Crown Solution (R2C™):

Every year around the world, dentists perform 200,000,000* endodontic and restorative procedures. The long-term success is based upon the combined success of all clinical steps. According to the literature, improperly performed endodontic and/or restorative measures can reduce the endodontic success rate from 90% to 18%** . To support the success of the dentists' endodontic and restorative direct or indirect procedures and raise the number of saved teeth, Dentsply Sirona offers innovative end-to-end solutions and products for each of the clinical steps.

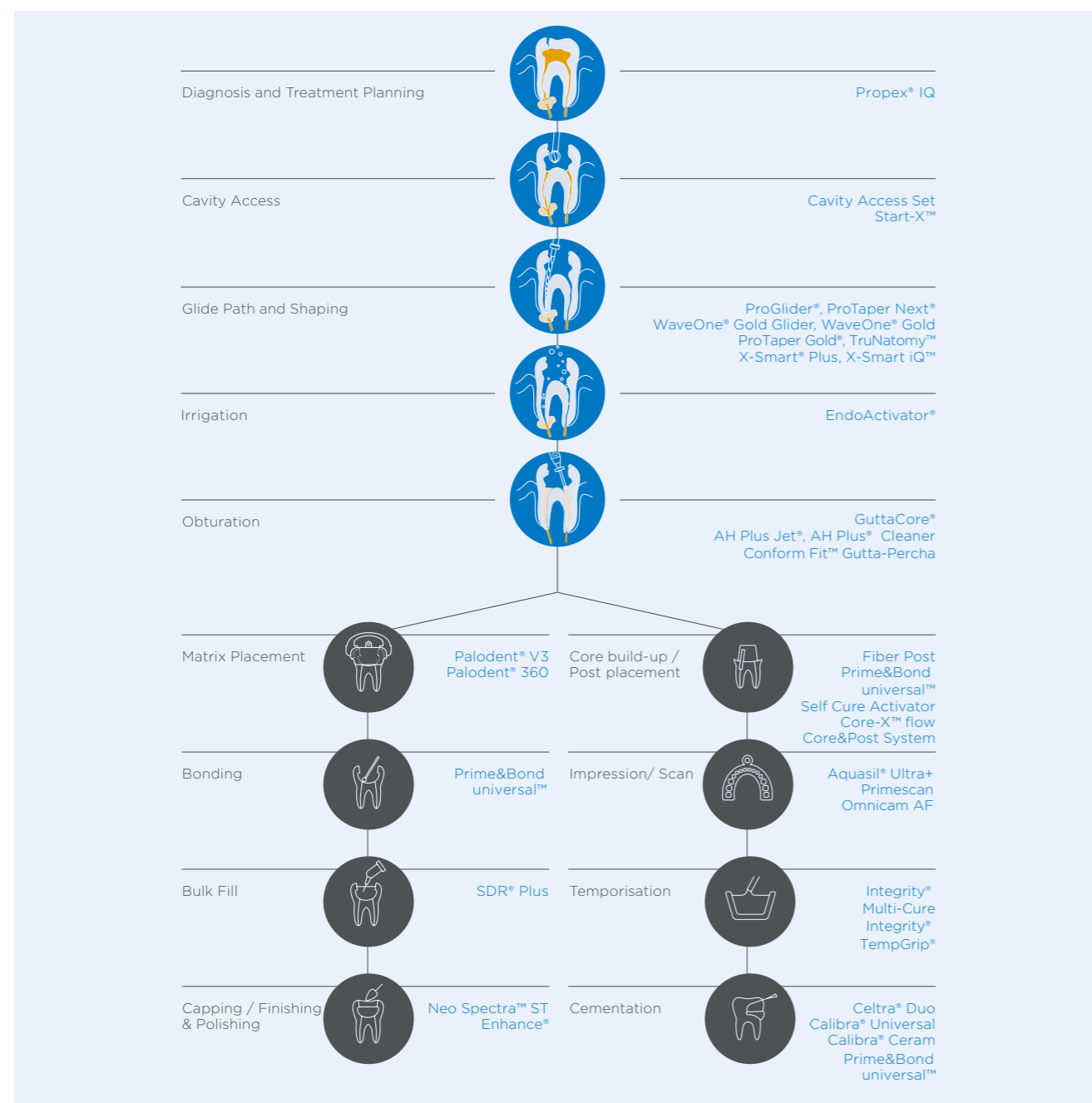

Contents



Diagnosis and Treatment Planning

Propex® IQ	145
------------	-----

Cavity Access and Shaping

Ultrasonic Tips and Root Canal Conditioner Start-X®	147
Access Burs	149

Manual Files

ReadySteel®	152
Glyde	161
M-Access®	162
ProTaper® (hand use files)	211

Glide Path Files

ProGlider®	165
PathFile®	165
TruNatomy™ Glider	166
WaveOne® Gold Glider	167

NiTi Files

ProTaper®	168
Spiro® Colorinox	168
TruNatomy™	169
ProTaper Next®	170
ProTaper Gold®	172
Profile®	173
WaveOne® Gold	174
ProTaper® (retreatment files)	176

Motors

X-Smart IQ™	177
X-Smart® Plus	178

Accessories

	179
--	-----

Irrigation

Endoactivator®	180
ProRinse®	181
Irrigation Needle	181

Obturation

AH Plus®, AH 26®, AH Temp®, AH Plus® Jet	182
Paper Points	183
Conform Fit™ Gutta-Percha	184
GuttaCore®	186
Thermafil®	188
Thermaprep® 2	189
Gutta-Smart®	190
Obturation Accessories	191

Pins and Posts

UNICLIP, MOOSER	192
Radix Anker®	193
EasyPost™	194
X-Post®	194

Surgical

ProRoot® MTA	194
--------------	-----

KEY FOR ENDODONTIC SYMBOLS:



DIAGNOSIS AND TREATMENT PLANNING / APEX LOCATOR

Propex IQ®

Increase your IQ with the perfect complement to your practice

Although the Propex IQ® can be used as a standalone item, its true advantages stand out when it is used in combination with the X-Smart IQ® via connection to the Endo IQ® App. When used with the X-Smart IQ® and the Endo IQ® App, the Propex IQ® allows you to efficiently and visually monitor file progression whilst shaping the canal at the same time.

Endurance

Can run combined with the X-Smart IQ® Handpiece and connected to the Endo IQ® App for up to 5.5 hours non-stop without a new battery charge.

Reliable and easy to use

- Guarantees reliable monitoring of file progression in both combined and standalone mode
- Works with various irrigation solutions if liquid is used
- Does not require any calibration; no adjustments need to be done

Ultra-light weight

Lightweight with only 80 grams and thus ultra-portable. Its form factor is smaller than the Propex Pixi®. Small in size but big on performance.

Future proof

Is fully integrated in the Endo IQ® App and its firmware can be upgraded via an app update.



Kits

B00PPIQWIGKIT	X-Smart® IQ & Propex IQ® WaveOne® Gold Starter Kit X-Smart IQ® Handpiece, Propex IQ® Apex Locator, Endo IQ® iPad Stand, with WaveOne® Gold and WaveOne® Gold Glider (34 files)
B00PPIQPTNKIT	X-Smart® IQ & Propex IQ® ProTaper Next® Starter Kit X-Smart IQ® Handpiece, Propex IQ® Apex Locator, Endo IQ® iPad Stand, with ProTaper Next® and ProGlider® (33 files)
B00PPIQPTGKIT	X-Smart® IQ & Propex IQ® ProTaper Gold® Starter Kit X-Smart IQ® Handpiece, Propex IQ® Apex Locator, Endo IQ® iPad Stand, with ProTaper Gold® and ProGlider® (33 files)
B00PPIQXIQKIT	X-Smart® IQ & Propex IQ® Basic Starter Kit X-Smart IQ® Handpiece, Propex IQ® Apex Locator and Endo IQ® iPad Stand
B00PPIQSTAKIT	Propex IQ® Basic Starter Kit Propex IQ® Apex Locator and Endo IQ® iPad Stand

Main Device

B00PPIQ000000	Propex IQ® Propex IQ® Apex Locator
---------------	--

Accessories

B00PPIQ1ACCHG	Propex IQ® Charger
B00PPIQ2ACFCL	Propex IQ® File Clip x2
B00PPIQ1ACCBCL	Propex IQ® Measurement Cable
B00PPIQ1ACTST	Propex IQ® External Tester
B00PPIQCLAMPO	Propex IQ® Clamp
B00PPIQ5ACLCL	Propex IQ® Lip Clip x5
B00PPIQ2ACBAT	Propex IQ® Rechargeable Battery
B00PPIQ1ACBAR	Propex IQ® Disposable Barrier Sleeves
B00IQ00STA000	Endo IQ® iPad Stand <ul style="list-style-type: none"> • Supports all iPad® sizes in landscape mode • 45 degree inclination • iPads® can be easily placed on stand

Try me with...

X-Smart IQ®

Get more from your cordless X-Smart IQ® Handpiece by simply combining it to the Propex IQ® Apex Locator via cable. Efficiently monitor file progression and shape the canal simultaneously while being wirelessly connected to the Endo IQ® App visualising file progression.





+
WE
KNOW
ENDO.



WaveOne® Gold
Now with WaveOne® Gold Glider

Surf the canal with confidence

WaveOne® Gold offers you the simplicity of a one-file shaping system combined with higher flexibility* to respect the canal anatomy. Now available with a corresponding glide path file to optimize your shaping preparation. Experience the feeling of confidence throughout your treatment.



*compared to WaveOne
© 2018 Dentsply Sirona, Inc.

CAVITY ACCESS AND SHAPING / **ULTRASONIC TIPS** 

Start-X®

Achieve higher control and precision with ultrasonic inserts specifically designed for access cavity refinement and canal orifice location

Start-X® ultrasonic tips are designed to improve the quality of endodontic treatments by helping to achieve higher control and precision. These simple-to-use tips have each been designed for a specific indication so that the dentist knows exactly which tip to use in which situation. The tips are made of hard-tempered stainless steel so they have strong resistance to wear and tear and the tips can vibrate in the air without breaking. The inserts have been designed to be exclusively used with a Piezo ultrasonic generator.

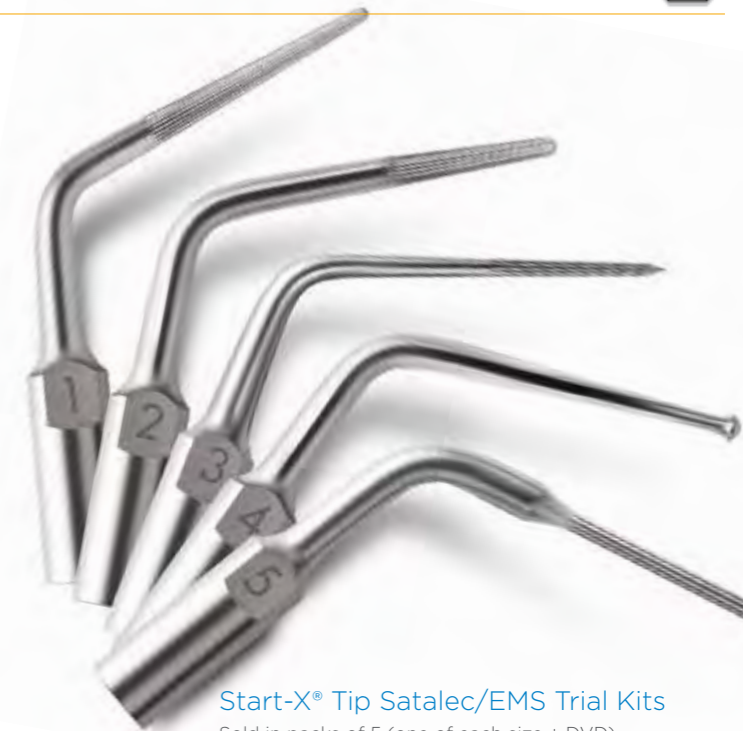

Start-X® Tip Satalec/EMS Trial Kits
Sold in packs of 5 (one of each size + DVD)

- A966000090100 Start-X® Tip Satalec Trial Kit
- A966100090100 Start-X® Tip EMS Trial Kit

Start-X® Tip Satalec/EMS Assorted
Sold in packs of 5

- A066000090000 Start-X® Tip Satalec Assortment
- A066100090000 Start-X® Tip EMS Assortment

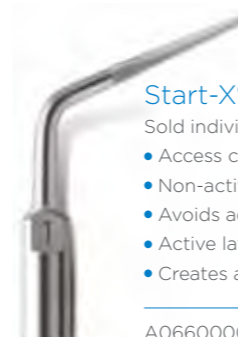

Start-X® Tip Satalec/EMS Insert 1
Sold individually

- Access cavity wall refinement
- Non-active tip
- Avoids accidentally damaging the pulp chamber floor
- Active lateral part
- Creates a straight access to the canal

- A066000000100 Start-X® Tip Satalec Insert 1
- A066100000100 Start-X® Tip EMS Insert 1

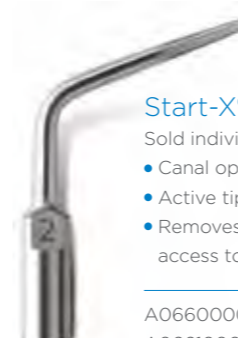

Start-X® Tip Satalec/EMS Insert 2
Sold individually

- Canal openings scouter
- Active tip
- Removes the obstructions that prevent a straight access to the canal

- A066000000200 Start-X® Tip Satalec Insert 2
- A066100000200 Start-X® Tip EMS Insert 2

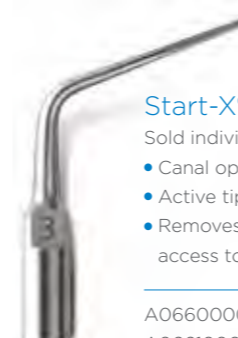

Start-X® Tip Satalec/EMS Insert 3
Sold individually

- Canal openings scouter
- Active tip
- Removes the obstructions that prevent a straight access to the canal

- A066000000300 Start-X® Tip Satalec Insert 3
- A066100000300 Start-X® Tip EMS Insert 3

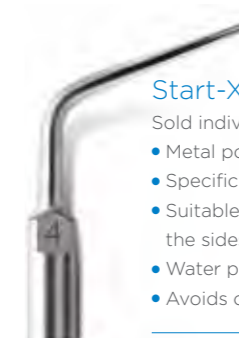

Start-X® Tip Satalec/EMS Insert 4
Sold individually

- Metal post removal
- Specific design
- Suitable for working efficiently both on the top and the sides of the metal post
- Water port
- Avoids overheating

- A066000000400 Start-X® Tip Satalec Insert 4
- A066100000400 Start-X® Tip EMS Insert 4

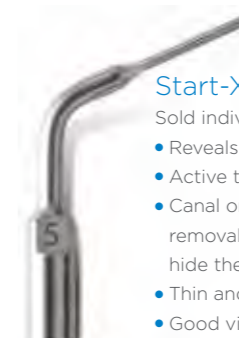

Start-X® Tip Satalec/EMS Insert 5
Sold individually

- Reveals the original pulp chamber floor anatomy
- Active tip
- Canal orifice location made easier thanks to the removal of calcifications and filling materials that hide the original pulp chamber floor anatomy
- Thin and cylindrical tip
- Good visibility

- A066000000500 Start-X® Tip Satalec Insert 5
- A066100000500 Start-X® Tip EMS Insert 5



CAVITY ACCESS AND SHAPING / ACCESS BURS

Access Burs

Give yourself all the chances you need to correctly start your root canal treatments



Cavity Access

- A030500000000 Cavity Access Set (1x X-Gates RA 32mm, 1x Carbide bur round FG 010, 1x Carbide bur round FG 014, 1x Diamond bur round M 016, 1x Diamond bur conical C 016, 1x Transmetal FG 19mm 012, 1x display case)
- A305Z00000000 Cavity Access Z Set (1x Diamond bur round FG 016, 1x Transmetal FG 012, 1x Carbide bur round FG 010, 1x Carbide bur round FG 014, 1x Endo Z bur FG, 1x X-Gates RA 32mm, 1x display case)

Cavity Access Burs

- Box of 6
 - F000134201600 Diamond Bur Cavity Round 314 M 016
 - F019934201600 Diamond Bur Conical Round FG M 016
- Blister pack of 5
 - E015334101200 Carbide Bur Transmetal Cyl. FG 012
 - E012334101000 Carbide Bur Cavity Round FG 010
 - E012334101400 Carbide Bur Cavity Round FG 014

Endo Access Burs

- Sold individually
 - A016430000100 Endo Access Bur FG 1, 21mm Ø 1.1mm
 - A016430000200 Endo Access Bur FG 2, 21mm Ø 1.5mm
 - A016430000300 Endo Access Bur FG 3, 21mm Ø 1.8mm
 - A016532100100 Diamendo Bur FG 21mm NO 1
 - A016532500200 Diamendo Bur FG 25mm NO 2FG

Cavity Burs (Carbide)

- Individual packs (x6 of one type)
 - E020524100610 Carbide Bur Long Neck RA 28mm 006
 - E020524100810 Carbide Bur Long Neck RA 28mm 008
 - E020524101010 Carbide Bur Long Neck RA 28mm 010
 - E020524101210 Carbide Bur Long Neck RA 28mm 012
 - E020524101410 Carbide Bur Long Neck RA 28mm 014
 - E020524101610 Carbide Bur Long Neck RA 28mm 016
- E020524190000 Carbide Bur Long Neck RA 28mm Assorted Pack (1x Carbide Bur Long Neck RA 28mm 006, 1x Carbide Bur Long Neck RA 28mm 008, 1x Carbide Bur Long Neck RA 28mm 010, 1x Carbide Bur Long Neck RA 28mm 012, 1x Carbide Bur Long Neck RA 28mm 014, 1x Carbide Bur Long Neck RA 28mm 016)

Gates Glidden Instruments

The items numbers shown below are for the non-CE marked packs only. To order a CE marked pack, replace the last two digits '12' with '00'.

Gates Glidden Instruments - 28mm

- Individual packs (x6 of one type)
 - A000823000112 RA 28mm Ø0.5mm
 - A000823000212 RA 28mm Ø0.7mm
 - A000823000312 RA 28mm Ø0.9mm
 - A000823000412 RA 28mm Ø1.1mm
 - A000823000512 RA 28mm Ø1.3mm
 - A000823000612 RA 28mm Ø1.5mm





CAVITY ACCESS AND SHAPING

Access Burs

A000823090112 RA 28mm Assorted Pack
(1x RA 28mm Ø0.5mm, 1x RA 28mm Ø0.7mm,
1x RA 28mm Ø0.9mm, 1x RA 28mm Ø1.1mm, 1x
RA 28mm Ø1.3mm, 1x RA 28mm Ø1.5mm)

Gates Glidden Instruments - 32mm

Individual packs (x6 of one type)

A000824000112 RA 32mm Ø0.5mm
A000824000212 RA 32mm Ø0.7mm
A000824000312 RA 32mm Ø0.9mm
A000824000412 RA 32mm Ø1.1mm
A000824000512 RA 32mm Ø1.3mm
A000824000612 RA 32mm Ø1.5mm

Largo Instruments

The items numbers shown below are for the non-CE marked packs only.
To order a CE marked pack, replace the last two digits '12' with '00'.

Largo Instruments - 28mm

Individual packs (x6 of one type)

A000923000112 RA 28mm Ø0.5mm
A000923000212 RA 28mm Ø0.7mm
A000923000312 RA 28mm Ø0.9mm
A000923000412 RA 28mm Ø1.1mm
A000923000512 RA 28mm Ø1.3mm
A000923000612 RA 28mm Ø1.5mm
A000923090112 RA 28mm Assorted Pack
(1x RA 28mm Ø0.5mm, 1x RA 28mm Ø0.7mm,
1x RA 28mm Ø0.9mm, 1x RA 28mm Ø1.1mm, 1x
RA 28mm Ø1.3mm, 1x RA 28mm Ø1.5mm)

Largo Instruments - 32mm

Individual packs (x6 of one type)

A000924000112 RA 32mm Ø0.5mm
A000924000212 RA 32mm Ø0.7mm
A000924000312 RA 32mm Ø0.9mm
A000924000412 RA 32mm Ø1.1mm
A000924000512 RA 32mm Ø1.3mm
A000924000612 RA 32mm Ø1.5mm
A000924090112 RA 32mm Assorted Pack
(1x RA 32mm Ø0.5mm, 1x RA 32mm Ø0.7mm,
1x RA 32mm Ø0.9mm, 1x RA 32mm Ø1.1mm, 1x
RA 32mm Ø1.3mm, 1x RA 32mm Ø1.5mm)

Zekrya Burs

Blister pack of 5

E015134100000 Zekrya Carb.B.Surgery FG 23mm
E015135100000 Zekrya Carb.B.Surgery FG 28mm
E015114100000 Zekrya Carb.B.Surgery PM B
E015124100000 Zekrya Carb.B.Surgery RA 26mm

Surgical Burs

Blister pack of 5

E015234100000 Carbide Bur Endo-Z FG 21mm (Bone Cutter)
E015334101200 Carbide Bur Transmetal Cylinder FG 012 (Metal
Trimming)



CAVITY ACCESS AND SHAPING / ACCESS BURS

Midwest® Burs and Handpieces

For precision, look straight to Midwest®

Midwest® burs

Midwest® burs include a complete line of blade carbides and oral surgical burs, as well as trimming and finishing burs, fine finishing burs, and criss-cross cut and fine cross cut styles. Midwest® burs are available in a variety of packages depending on your practice's specific needs.

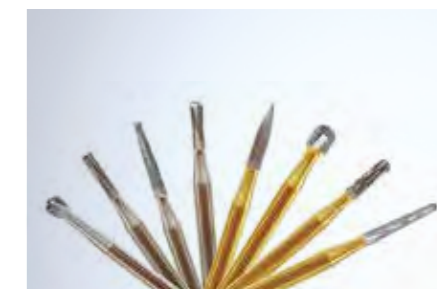

FG means Friction Grip.

- **Midwest® Operative Burs FG and Non FG** - Provide excellent cutting performance, and include an extensive selection of shapes and sizes in familiar configurations to meet your clinical needs.
- **Midwest® Trimming and Finishing Burs FG** - Often used by dentists to smooth the walls of a prepared tooth, finish and polish composite and porcelain restorations and by orthodontists to remove bonding adhesive used to place brackets.
- **Midwest® Surgical Burs FG and Non FG** - Cutting instruments with optimised blade geometry to facilitate efficient material discharge and further reduce bur chatter and potential clogging.
- **Midwest® Multiprep™ Burs FG** - Has a proprietary blade geometry for maximising cutting efficiency. Less force is required to achieve the same cutting rate as other burs.



Midwest® handpieces

Midwest® offer a quality line of air driven handpieces - Quiet Air®, Tradition® and Stylus™. These models come with a variety of features to fit your handpiece preference: Fiber optic and non-fiber optic, standard, latch and push button chuck styles, 5-hole and 6-pin.



CAVITY ACCESS AND SHAPING

Instruments

Rubber Dam

A406000000000 Rubber Dam Kit
A4011000000000 Rubber Dam - Heavy
A4010000000000 Rubber Dam - Medium
A4008000000000 Rubber Dam Clamp 'M2W'

Probes

B009300400600 Probe Double Ended 4-6
B0093F0400600 Probe Double Ended 4F-6F
B00930DG01600 Probe Double Ended DG16
B093S04F06F00 Probe Double Ended Silic.4F-6F

Excavators

B009500100200 Excavator Double Ended 1-2
B009500300400 Excavator Double Ended 3-4
B009500500600 Excavator Double Ended 5-6
B009500700800 Excavator Double Ended 7-8
B009500901000 Excavator Double Ended 9-10
B009501101200 Excavator Double Ended 11-12
B009501301400 Excavator Double Ended 13-14
B009501501600 Excavator Double Ended 15-16
B009501701800 Excavator Double Ended 17-18
B009501902000 Excavator Double Ended 19-20
B009502102200 Excavator Double Ended 21-22
B009502302400 Excavator Double Ended 23-24

B009502702800 Excavator Double Ended 27-28
B009502903000 Excavator Double Ended 29-30
B009503303400 Excavator Double Ended 33-34
B009503503600 Excavator Double Ended 35-36
B009503904000 Excavator Double Ended 39-40
B009504104200 Excavator Double Ended 41-42
B009504504600 Excavator Double Ended 45-46
B009504704800 Excavator Double Ended 47-48
B009504905000 Excavator Double Ended 49-50
B009505105200 Excavator Double Ended 51-52
B009505305400 Excavator Double Ended 53-54
B009505505600 Excavator Double Ended 55-56
B009505705800 Excavator Double Ended 57-58
B009505906000 Excavator Double Ended 59-60
B009506106200 Excavator Double Ended 61-62
B009506306400 Excavator Double Ended 63-64
B009506506600 Excavator Double Ended 65-66
B009506706800 Excavator Double Ended 67-68
B009506907000 Excavator Double Ended 69-70
B009507107200 Excavator Double Ended 71-72
B009507507600 Excavator Double Ended 75-76
B009507707800 Excavator Double Ended 77-78
B009508108200 Excavator Double Ended 81-82
B009508308400 Excavator Double Ended 83-84



CAVITY ACCESS AND SHAPING / MANUAL FILES

ReadySteel®

Ready when you are

ReadySteel® is a complete range of sterile, ready-to-use handfiles.

Save time

Save the sterilisation before treatment step thanks to the sterile blister keeping your handfiles disinfected until the first usage.

Make your staff more efficient

Simplify the preparation of the instruments for you or your dental nurse thanks to the sterile blister.

Reduce cross-contamination risks¹

Maximise the patient safety when you use it for single patient use, reducing the risk of cross-contamination.

Be ready for all endodontic cases²

Thanks to its complete range, you will be able to treat all kinds of endo cases you will have to face in your dental practice.

We Know Endo

The Dentsply Sirona Endodontics handfiles will provide you the quality and performance you expect.



Safety hole on the plastic handle



Individual alveolus, easy to separate

Sterile blister

¹ Popovic J, Gasic J, Zivkovic S, Petrovic A, Radicevic G. Evaluation of biological debris on endodontic instruments after cleaning and sterilization procedures. Int Endod J. 2010 Apr;43(4):336-41. // Walker JT, Dickinson J, Sutton JM, Raven ND, Marsh PD. Cleanability of dental instruments--implications of residual protein and risks from Creutzfeldt-Jakob disease. Br Dent J. 2007 Oct 13;203(7):395-401. // Smith A, Letters S, Lange A, Perrett D, McHugh S, Bagg J. Residual protein levels on reprocessed dental instruments. J Hosp Infect. 2005 Nov;61(3):237-41. // Linsuwanont P, Parashos P, Messer HH. Cleaning of rotary nickel-titanium endodontic instruments. Int Endod J. 2004 Jan;37(1):19-28.

² Case report: Ghoddsi J, Naghavi N, Zarei M, Rohani E. Mandibular first molar with four distal canals. J Endod. 2007 Dec;33(12):1481-3.

ReadySteel® K-Files - 18mm

Sold in a sterile blister of 6 files

Item Number	Tip Size ISO
A012D01800604	006
A012D01800804	008
A012D01801004	010

ReadySteel® K-Files - 21mm

Sold in a sterile blister of 6 files

Item Number	Tip Size ISO	Assortment Packs 1 sterile blister of 6 files
A012D02100604	006	N/A
A012D02100804	008	
A012D02101004	010	
A012D02101504	015	A012D02190004 015 x1, 020 x1, 025 x1, 030 x1, 035 x1, 040 x1
A012D02102004	020	
A012D02102504	025	
A012D02103004	030	
A012D02103504	035	
A012D02104004	040	
A012D02104504	045	A012D02190104 045 x1, 050 x1, 055 x1, 060 x1, 0710 x1, 080 x1
A012D02105004	050	
A012D02105504	055	
A012D02106004	060	
A012D02107004	070	
A012D02108004	080	
A012D02109004	090	A012D02190204 090 x1, 100 x1, 110 x1, 120 x1, 130 x1, 140 x1
A012D02110004	100	
A012D02110004	110	
A012D02112004	120	
A012D02113004	130	
A012D02114004	140	

ReadySteel® K-Files - 25mm

Sold in a sterile blister of 6 files

Item Number	Tip Size ISO	Assortment Packs 1 sterile blister of 6 files
A012D02500604	006	N/A
A012D02500804	008	
A012D02501004	010	
A012D02501504	015	A012D02590004 015 x1, 020 x1, 025 x1, 030 x1, 035 x1, 040 x1
A012D02502004	020	
A012D02502504	025	
A012D02503004	030	
A012D02503504	035	
A012D02504004	040	
A012D02504504	045	A012D02590104 045 x1, 050 x1, 055 x1, 060 x1, 0710 x1, 080 x1
A012D02505004	050	
A012D02505504	055	
A012D02506004	060	
A012D02507004	070	
A012D02508004	080	
A012D02509004	090	A012D02590204 090 x1, 100 x1, 110 x1, 120 x1, 130 x1, 140 x1
A012D02510004	100	
A012D02511004	110	
A012D02512004	120	
A012D02513004	130	
A012D02514004	140	

ReadySteel® K-Files - 28mm

Sold in a sterile blister of 6 files

Item Number	Tip Size ISO	Assortment Packs 1 sterile blister of 6 files
A012D02800604	006	N/A
A012D02800804	008	
A012D02801004	010	
A012D02801504	015	A012D02890004 015 x1, 020 x1, 025 x1, 030 x1, 035 x1, 040 x1
A012D02802004	020	
A012D02802504	025	
A012D02803004	030	
A012D02803504	035	
A012D02804004	040	
A012D02804504	045	A012D02890104 045 x1, 050 x1, 055 x1, 060 x1, 0710 x1, 080 x1
A012D02805004	050	
A012D02805504	055	
A012D02806004	060	
A012D02807004	070	
A012D02808004	080	
A012D02809004	090	A012D02890204 090 x1, 100 x1, 110 x1, 120 x1, 130 x1, 140 x1
A012D02810004	100	
A012D02811004	110	
A012D02812004	120	
A012D02813004	130	
A012D02814004	140	

ReadySteel® K-Files - 31mm

Sold in a sterile blister of 6 files

Item Number	Tip Size ISO	Assortment Packs 1 sterile blister of 6 files
A012D03100604	006	N/A
A012D03100804	008	
A012D03101004	010	
A012D03101504	015	A012D03190004 015 x1, 020 x1, 025 x1, 030 x1, 035 x1, 040 x1
A012D03102004	020	
A012D03102504	025	
A012D03103004	030	
A012D03103504	035	
A012D03104004	040	
A012D03104504	045	A012D03190104 045 x1, 050 x1, 055 x1, 060 x1, 0710 x1, 080 x1
A012D03105004	050	
A012D03105504	055	
A012D03106004	060	
A012D03107004	070	
A012D03108004	080	
A012D03109004	090	A012D03190204 090 x1, 100 x1, 110 x1, 120 x1, 130 x1, 140 x1
A012D03110004	100	
A012D03111004	110	
A012D03112004	120	
A012D03113004	130	
A012D03114004	140	

Hedstroem Files offer effective cutting efficiency. Greater strength provided by its thick core, enables Dentsply Sirona to offer you smaller hedstroem files starting at 008.

C+ Files facilitate penetration in calcified canals vs K-Files: Thanks to their specific file design, they are more resistant to buckling.

ReadySteel® Hedstroem Files – 21mm

Sold in a sterile blister of 6 files

Item Number	Tip Size ISO	Assortment Packs 1 sterile blister of 6 files
A016D02100804	008	N/A
A016D02101004	010	
A016D02101504	015	
A016D02102004	020	A016D02190004 015 x1, 020 x1, 025 x1, 030 x1, 035 x1, 040 x1
A016D02102504	025	
A016D02103004	030	
A016D02103504	035	
A016D02104004	040	
A016D02104504	045	
A016D02105004	050	A016D02190104 045 x1, 050 x1, 055 x1, 060 x1, 0710 x1, 080 x1
A016D02105504	055	
A016D02106004	060	
A016D02107004	070	
A016D02108004	080	A016D02190204 090 x1, 100 x1, 110 x1, 120 x1, 130 x1, 140 x1
A016D02109004	090	
A016D02110004	100	
A016D02111004	110	
A016D02112004	120	
A016D02113004	130	
A016D02114004	140	

ReadySteel® Hedstroem Files – 28mm

Sold in a sterile blister of 6 files

Item Number	Tip Size ISO	Assortment Packs 1 sterile blister of 6 files
A016D02800804	008	N/A
A016D02801004	010	
A016D02801504	015	
A016D02802004	020	A016D02890004 015 x1, 020 x1, 025 x1, 030 x1, 035 x1, 040 x1
A016D02802504	025	
A016D02803004	030	
A016D02803504	035	
A016D02804004	040	
A016D02804504	045	
A016D02805004	050	A016D02890104 045 x1, 050 x1, 055 x1, 060 x1, 0710 x1, 080 x1
A016D02805504	055	
A016D02806004	060	
A016D02807004	070	
A016D02808004	080	A016D02890204 090 x1, 100 x1, 110 x1, 120 x1, 130 x1, 140 x1
A016D02809004	090	
A016D02810004	100	
A016D02811004	110	
A016D02812004	120	
A016D02813004	130	
A016D02814004	140	

ReadySteel® C+ Files – 18mm

Sold in a sterile blister of 6 files

Item Number	Tip Size ISO	Assortment Pack 1 sterile blister of 6 files
A012X01800604	006	A012X01890004 008 x2, 010 x2, 015 x2
A012X01800804	008	
A012X01801004	010	
A012X01801504	015	
A012X01802004	020	

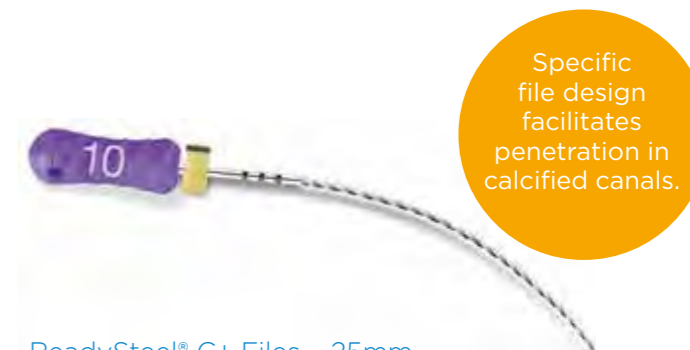

ReadySteel® C+ Files – 21mm

Sold in a sterile blister of 6 files

Item Number	Tip Size ISO	Assortment Packs 1 sterile blister of 6 files
A012X02100604	006	A012X02190004 008 x2, 010 x2, 015 x2
A012X02100804	008	
A012X02101004	010	
A012X02101504	015	
A012X02102004	020	

ReadySteel® C+ Files – 25mm

Sold in a sterile blister of 6 files

Item Number	Tip Size ISO	Assortment Pack 1 sterile blister of 6 files
A012X02500604	006	A012X02590004 008 x2, 010 x2, 015 x2
A012X02500804	008	
A012X02501004	010	
A012X02501504	015	
A012X02502004	020	

K-Reamer Files offer precise handling and the ability to remove excess debris from the canal.

ReadySteel® Hedstroem Files – 25mm

Sold in a sterile blister of 6 files

Item Number	Tip Size ISO	Assortment Packs 1 sterile blister of 6 files
A016D02500804	008	N/A
A016D02501004	010	
A016D02501504	015	
A016D02502004	020	A016D02590004 015 x1, 020 x1, 025 x1, 030 x1, 035 x1, 040 x1
A016D02502504	025	
A016D02503004	030	
A016D02503504	035	
A016D02504004	040	
A016D02504504	045	
A016D02505004	050	A016D02590104 045 x1, 050 x1, 055 x1, 060 x1, 0710 x1, 080 x1
A016D02505504	055	
A016D02506004	060	
A016D02507004	070	
A016D02508004	080	A016D02590204 090 x1, 100 x1, 110 x1, 120 x1, 130 x1, 140 x1
A016D02509004	090	
A016D02510004	100	
A016D02511004	110	
A016D02512004	120	
A016D02513004	130	
A016D02514004	140	

ReadySteel® Hedstroem Files – 31mm

Sold in a sterile blister of 6 files

Item Number	Tip Size ISO	Assortment Packs 1 sterile blister of 6 files
A016D03100804	008	N/A
A016D03101004	010	
A016D03101504	015	
A016D03102004	020	A016D03190004 015 x1, 020 x1, 025 x1, 030 x1, 035 x1, 040 x1
A016D03102504	025	
A016D03103004	030	
A016D03103504	035	
A016D03104004	040	
A016D03104504	045	
A016D03105004	050	A016D03190104 045 x1, 050 x1, 055 x1, 060 x1, 0710 x1, 080 x1
A016D03105504	055	
A016D03106004	060	
A016D03107004	070	
A016D03108004	080	A016D03190204 090 x1, 100 x1, 110 x1, 120 x1, 130 x1, 140 x1
A016D03109004	090	
A016D03110004	100	
A016D03111004	110	
A016D03112004	120	
A016D03113004	130	
A016D03114004	140	

ReadySteel® K-Reamer Files – 21mm

Sold in a sterile blister of 6 files

Item Number	Tip Size ISO	Assortment Packs 1 sterile blister of 6 files
A011D02100804	008	N/A
A011D02101004	010	
A011D02101504	015	
A011D02102004	020	A011D02190004 015 x1, 020 x1, 025 x1, 030 x1, 035 x1, 040 x1
A011D02102504	025	
A011D02103004	030	
A011D02103504	035	
A011D02104004	040	
A011D02104504	045	
A011D02105004	050	A011D02190104 045 x1, 050 x1, 055 x1, 060 x1, 0710 x1, 080 x1
A011D02105504	055	
A011D02106004	060	
A011D02107004	070	
A011D02108004	080	A011D02190204 090 x1, 100 x1, 110 x1, 120 x1, 130 x1, 140 x1
A011D02109004	090	
A011D02110004	100	
A011D02111004	110	
A011D02112004	120	
A011D02113004	130	
A011D02114004	140	

ReadySteel® K-Reamer Files – 25mm

Sold in a sterile blister of 6 files

Item Number	Tip Size ISO	Assortment Packs 1 sterile blister of 6 files
A011D02500804	008	N/A
A011D02501004	010	
A011D02501504	015	
A011D02502004	020	A011D02590004 015 x1, 020 x1, 025 x1, 030 x1, 035 x1, 040 x1
A011D02502504	025	
A011D02503004	030	
A011D02503504	035	
A011D02504004	040	
A011D02504504	045	
A011D02505004	050	A011D02590104 045 x1, 050 x1, 055 x1, 060 x1, 0710 x1, 080 x1
A011D02505504	055	
A011D02506004	060	
A011D02507004	070	
A011D02508004	080	A011D02590204 090 x1, 100 x1, 110 x1, 120 x1, 130 x1, 140 x1
A011D02509004	090	
A011D02510004	100	
A011D02511004	110	
A011D02512004	120	
A011D02513004	130	
A011D02514004	140	

ReadySteel® K-Reamer Files – 28mm

Sold in a sterile blister of 6 files

Item Number	Tip Size ISO	Assortment Packs 1 sterile blister of 6 files
A011D02800804	008	N/A
A011D02801004	010	
A011D02801504	015	
A011D02802004	020	A011D02890004 015 x1, 020 x1, 025 x1, 030 x1, 035 x1, 040 x1
A011D02802504	025	
A011D02803004	030	
A011D02803504	035	
A011D02804004	040	
A011D02804504	045	A011D02890104 045 x1, 050 x1, 055 x1, 060 x1, 0710 x1, 080 x1
A011D02805004	050	
A011D02805504	055	
A011D02806004	060	
A011D02807004	070	
A011D02808004	080	A011D02890204 090 x1, 100 x1, 110 x1, 120 x1, 130 x1, 140 x1
A011D02809004	090	
A011D02810004	100	
A011D02811004	110	
A011D02812004	120	
A011D02813004	130	
A011D02814004	140	

ReadySteel® K-Reamer Files – 31mm

Sold in a sterile blister of 6 files

Item Number	Tip Size ISO	Assortment Packs 1 sterile blister of 6 files
A011D03100804	008	N/A
A011D03101004	010	
A011D03101504	015	
A011D03102004	020	A011D03190004 015 x1, 020 x1, 025 x1, 030 x1, 035 x1, 040 x1
A011D03102504	025	
A011D03103004	030	
A011D03103504	035	
A011D03104004	040	
A011D03104504	045	A011D03190104 045 x1, 050 x1, 055 x1, 060 x1, 0710 x1, 080 x1
A011D03105004	050	
A011D03105504	055	
A011D03106004	060	
A011D03107004	070	
A011D03108004	080	A011D03190204 090 x1, 100 x1, 110 x1, 120 x1, 130 x1, 140 x1
A011D03109004	090	
A011D03110004	100	
A011D03111004	110	
A011D03112004	120	
A011D03113004	130	
A011D03114004	140	



Combines
the best
stainless steel
technology
with enhanced
flexibility.

ReadySteel® K-Flexofiles – 18mm

Sold in a sterile blister of 6 files

Item Number	Tip Size ISO	Assortment Pack 1 sterile blister of 6 files
A012C01801504	015	A012C01890004 015 x1, 020 x1, 025 x1, 030 x1, 035 x1, 040 x1
A012C01802004	020	
A012C01802504	025	
A012C01803004	030	
A012C01803504	035	
A012C01804004	040	

ReadySteel® K-Flexofiles – 21mm

Sold in a sterile blister of 6 files

Item Number	Tip Size ISO	Assortment Packs 1 sterile blister of 6 files
A012C02100604	006	N/A
A012C02100804	008	
A012C02101004	010	
A012C02101504	015	A012C02190004 015 x1, 020 x1, 025 x1, 030 x1, 035 x1, 040 x1
A012C02102004	020	
A012C02102504	025	
A012C02103004	030	
A012C02103504	035	
A012C02104004	040	A012C02190104 045 x1, 050 x1, 055 x1, 060 x1, 0710 x1, 080 x1
A012C02104504	045	
A012C02105004	050	
A012C02105504	055	
A012C02106004	060	
A012C02107004	070	A012C02190204 090 x1, 100 x1, 110 x1, 120 x1, 130 x1, 140 x1
A012C02108004	080	
A012C02109004	090	
A012C02110004	100	
A012C02111004	110	
A012C02112004	120	
A012C02113004	130	
A012C02114004	140	

ReadySteel® K-Flexofiles – 25mm

Sold in a sterile blister of 6 files

Item Number	Tip Size ISO	Assortment Packs 1 sterile blister of 6 files
A012C02500604	006	N/A
A012C02500804	008	
A012C02501004	010	
A012C02501504	015	A012C02590004 015 x1, 020 x1, 025 x1, 030 x1, 035 x1, 040 x1
A012C02502004	020	
A012C02502504	025	
A012C02503004	030	
A012C02503504	035	
A012C02504004	040	A012C02590104 045 x1, 050 x1, 055 x1, 060 x1, 0710 x1, 080 x1
A012C02504504	045	
A012C02505004	050	
A012C02505504	055	
A012C02506004	060	
A012C02507004	070	A012C02590204 090 x1, 100 x1, 110 x1, 120 x1, 130 x1, 140 x1
A012C02508004	080	
A012C02509004	090	
A012C02510004	100	
A012C02511004	110	
A012C02512004	120	
A012C02513004	130	
A012C02514004	140	

ReadySteel® K-Flexofiles – 31mm

Sold in a sterile blister of 6 files

Item Number	Tip Size ISO	Assortment Packs 1 sterile blister of 6 files
A012C03100604	006	N/A
A012C03100804	008	
A012C03101004	010	
A012C03101504	015	A012C03190004 015 x1, 020 x1, 025 x1, 030 x1, 035 x1, 040 x1
A012C03102004	020	
A012C03102504	025	
A012C03103004	030	
A012C03103504	035	
A012C03104004	040	A012C03190104 045 x1, 050 x1, 055 x1, 060 x1, 0710 x1, 080 x1
A012C03104504	045	
A012C03105004	050	
A012C03105504	055	
A012C03106004	060	
A012C03107004	070	A012C03190204 090 x1, 100 x1, 110 x1, 120 x1, 130 x1, 140 x1
A012C03108004	080	
A012C03109004	090	
A012C03110004	100	
A012C03111004	110	
A012C03112004	120	
A012C03113004	130	
A012C03114004	140	



ReadySteel® Flexoreamer – 21mm

Sold in a sterile blister of 6 files

Item Number	Tip Size ISO	Assortment Pack 1 sterile blister of 6 files
A011C02101504	015	A011C02190004 015 x1, 020 x1, 025 x1, 030 x1, 035 x1, 040 x1
A011C02102004	020	
A011C02102504	025	
A011C02103004	030	
A011C02103504	035	
A011C02104004	040	

ReadySteel® Flexoreamer – 31mm

Sold in a sterile blister of 6 files

Item Number	Tip Size ISO	Assortment Pack 1 sterile blister of 6 files
A011C03101504	015	A011C03190004 015 x1, 020 x1, 025 x1, 030 x1, 035 x1, 040 x1
A011C03102004	020	
A011C03102504	025	
A011C03103004	030	
A011C03103504	035	
A011C03104004	040	

ReadySteel® Flexoreamer – 25mm

Sold in a sterile blister of 6 files

Item Number	Tip Size ISO	Assortment Pack 1 sterile blister of 6 files
A011C02501504	015	A011C02590004 015 x1, 020 x1, 025 x1, 030 x1, 035 x1, 040 x1
A011C02502004	020	
A011C02502504	025	
A011C02503004	030	
A011C02503504	035	
A011C02504004	040	

With enhanced flexibility*, Flexofiles and Flexoreamers will reduce the risk of canal transportation.*

*vs K-Files and K-Reamers respectively

ReadySteel® Gold Medium Flexofiles - 21mm

Sold in a sterile blister of 6 files

Item Number	Tip Size ISO	Assortment Pack 1 sterile blister of 6 files
A012I02101204	012	A012I02190104 012 x1, 017 x1, 022 x1, 027 x1, 032 x1, 037 x1
A012I02101704	017	
A012I02102204	022	
A012I02102704	027	
A012I02103204	032	
A012I02103704	037	

ReadySteel® Gold Medium Flexofiles - 25mm

Sold in a sterile blister of 6 files

Item Number	Tip Size ISO	Assortment Pack 1 sterile blister of 6 files
A012I02501204	012	A012I02590104 012 x1, 017 x1, 022 x1, 027 x1, 032 x1, 037 x1
A012I02501704	017	
A012I02502204	022	
A012I02502704	027	
A012I02503204	032	
A012I02503704	037	

ReadySteel® Gold Medium Flexofiles - 31mm

Sold in a sterile blister of 6 files

Item Number	Tip Size ISO	Assortment Pack 1 sterile blister of 6 files
A012I03101204	012	A012I03190104 012 x1, 017 x1, 022 x1, 027 x1, 032 x1, 037 x1
A012I03101704	017	
A012I03102204	022	
A012I03102704	027	
A012I03103204	032	
A012I03103704	037	

ReadySteel® Senseus Flexoreamer Files - 21mm

Sold in a sterile blister of 6 files

Item Number	Tip Size ISO	Assortment Packs 1 sterile blister of 6 files
A101102100804	008	N/A
A101102101004	010	
A101102101504	015	
A101102102004	020	A101102190004 015 x1, 020 x1, 025 x1, 030 x1, 035 x1, 040 x1
A101102102504	025	
A101102103004	030	
A101102103504	035	
A101102104004	040	A101102190104 045 x1, 050 x1, 055 x1, 060 x1, 070 x1, 080 x1
A101102104504	045	
A101102105004	050	
A101102105504	055	
A101102106004	060	
A101102107004	070	
A101102108004	080	



ReadySteel® Senseus Flexoreamer Files - 25mm

Sold in a sterile blister of 6 files

Item Number	Tip Size ISO	Assortment Packs 1 sterile blister of 6 files
A101102500804	008	N/A
A101102501004	010	
A101102501504	015	
A101102502004	020	A101102590004 015 x1, 020 x1, 025 x1, 030 x1, 035 x1, 040 x1
A101102502504	025	
A101102503004	030	
A101102503504	035	
A101102504004	040	A101102590104 045 x1, 050 x1, 055 x1, 060 x1, 070 x1, 080 x1
A101102504504	045	
A101102505004	050	
A101102505504	055	
A101102506004	060	
A101102507004	070	
A101102508004	080	

ReadySteel® Senseus Flexoreamer Files - 31mm

Sold in a sterile blister of 6 files

Item Number	Tip Size ISO	Assortment Packs 1 sterile blister of 6 files
A101103100804	008	N/A
A101103101004	010	
A101103101504	015	
A101103102004	020	A101103190004 015 x1, 020 x1, 025 x1, 030 x1, 035 x1, 040 x1
A101103102504	025	
A101103103004	030	
A101103103504	035	
A101103104004	040	A101103190104 045 x1, 050 x1, 055 x1, 060 x1, 070 x1, 080 x1
A101103104504	045	
A101103105004	050	
A101103105504	055	
A101103106004	060	
A101103107004	070	
A101103108004	080	

ReadySteel® Senseus Flexofile - 21mm

Sold in a sterile blister of 6 files

Item Number	Tip Size ISO	Assortment Packs 1 sterile blister of 6 files
A101202100604	006	N/A
A101202100804	008	
A101202101004	010	
A101202101504	015	A101202190004 015 x1, 020 x1, 025 x1, 030 x1, 035 x1, 040 x1
A101202102004	020	
A101202102504	025	
A101202103004	030	
A101202103504	035	A101202190104 045 x1, 050 x1, 055 x1, 060 x1, 070 x1, 080 x1
A101202104004	040	
A101202104504	045	
A101202105004	050	
A101202105504	055	
A101202106004	060	
A101202107004	070	
A101202108004	080	

ReadySteel® Senseus Flexofile - 25mm

Sold in a sterile blister of 6 files

Item Number	Tip Size ISO	Assortment Packs 1 sterile blister of 6 files
A101202500604	006	N/A
A101202500804	008	
A101202501004	010	
A101202501504	015	A101202590004 015 x1, 020 x1, 025 x1, 030 x1, 035 x1, 040 x1
A101202502004	020	
A101202502504	025	
A101202503004	030	
A101202503504	035	A101202590104 045 x1, 050 x1, 055 x1, 060 x1, 070 x1, 080 x1
A101202504004	040	
A101202504504	045	
A101202505004	050	
A101202505504	055	
A101202506004	060	
A101202507004	070	
A101202508004	080	

The Senseus range have a more comfortable silicone handle vs the plastic handle for the standard range.



ReadySteel® Senseus Flexofile - 31mm

Sold in a sterile blister of 6 files

Item Number	Tip Size ISO	Assortment Packs 1 sterile blister of 6 files
A101203100604	006	N/A
A101203100804	008	
A101203101004	010	
A101203101504	015	A101203190004 015 x1, 020 x1, 025 x1, 030 x1, 035 x1, 040 x1
A101203102004	020	
A101203102504	025	
A101203103004	030	
A101203103504	035	A101203190104 045 x1, 050 x1, 055 x1, 060 x1, 070 x1, 080 x1
A101203104004	040	
A101203104504	045	
A101203105004	050	
A101203105504	055	
A101203106004	060	
A101203107004	070	
A101203108004	080	

ReadySteel® Senseus Hedstorem Files - 21mm

Sold in a sterile blister of 6 files

Item Number	Tip Size ISO	Assortment Packs 1 sterile blister of 6 files
A101602100804	008	N/A
A101602101004	010	
A101602101504	015	
A101602102004	020	A101602190004 015 x1, 020 x1, 025 x1, 030 x1, 035 x1, 040 x1
A101602102504	025	
A101602103004	030	
A101602103504	035	
A101602104004	040	A101602190104 045 x1, 050 x1, 055 x1, 060 x1, 070 x1, 080 x1
A101602104504	045	
A101602105004	050	
A101602105504	055	
A101602106004	060	
A101602107004	070	
A101602108004	080	

ReadySteel® Senseus Hedstorem Files - 25mm

Sold in a sterile blister of 6 files

Item Number	Tip Size ISO	Assortment Packs 1 sterile blister of 6 files
A101602500804	008	N/A
A101602501004	010	
A101602501504	015	
A101602502004	020	A101602590004 015 x1, 020 x1, 025 x1, 030 x1, 035 x1, 040 x1
A101602502504	025	
A101602503004	030	
A101602503504	035	
A101602504004	040	
A101602504504	045	A101602590104 045 x1, 050 x1, 055 x1, 060 x1, 0710 x1, 080 x1
A101602505004	050	
A101602505504	055	
A101602506004	060	
A101602507004	070	
A101602508004	080	

ReadySteel® Senseus Hedstorem Files - 31mm

Sold in a sterile blister of 6 files

Item Number	Tip Size ISO	Assortment Packs 1 sterile blister of 6 files
A101603100804	008	N/A
A101603101004	010	
A101603101504	015	
A101603102004	020	A101603190004 015 x1, 020 x1, 025 x1, 030 x1, 035 x1, 040 x1
A101603102504	025	
A101603103004	030	
A101603103504	035	
A101603104004	040	
A101603104504	045	A101603190104 045 x1, 050 x1, 055 x1, 060 x1, 0710 x1, 080 x1
A101603105004	050	
A101603105504	055	
A101603106004	060	
A101603107004	070	
A101603108004	080	

One action, one sterile solution, one range. Ready to start when you are.

ReadySteel® Senseus Profinder Files - 18mm

Sold in a sterile blister of 6 files

Item Number	Tip Size ISO	Assortment Pack 1 sterile blister of 6 files
A101301801004	010	A101301890004 010 x2, 013 x2, 017 x2
A101301801304	013	
A101301801704	017	

ReadySteel® Senseus Profinder Files - 21mm

Sold in a sterile blister of 6 files

Item Number	Tip Size ISO	Assortment Pack 1 sterile blister of 6 files
A101302101004	010	A101302190004 010 x2, 013 x2, 017 x2
A101302101304	013	
A101302101704	017	

ReadySteel® Senseus Profinder Files - 25mm

Sold in a sterile blister of 6 files

Item Number	Tip Size ISO	Assortment Pack 1 sterile blister of 6 files
A101302501004	010	A101302590004 010 x2, 013 x2, 017 x2
A101302501304	013	
A101302501704	017	

CAVITY ACCESS AND SHAPING / ROOT CANAL CONDITIONER
Glyde™

Makes root canal treatment easier

Glyde™ file prep root canal conditioner makes root canal treatment easier whichever preparation method is used.

- Reduces the risk of instruments fracturing by acting as a lubricant
- Helps to flush out debris
- Canal walls are free of a smear layer due to EDTA and its softening effect
- Chemically cleans and removes smear layer thanks to urea peroxide
- Complete removal by rinsing

A09010000000 Glyde™ Syringe Kit (3x 3ml syringes)

A09020000000 Glyde™ Intro Pack (2x 3ml syringes, 25x syringe tips)

A09030000000 Glyde™ Syringe Tips (50 tips per pack)

A09050000000 Glyde Single Doses (35x 0.5ml per pack)

Smooth, gel like consistency clings to files making precise placement in the canal easy.





CAVITY ACCESS AND SHAPING / MANUAL FILES 

M-Access®

A heritage of timeless precision and quality in stainless steel

M-Access® offers Swiss made quality and is the comprehensive and affordable handfile range specifically designed to offer clinicians simplicity and efficiency. M-Access® has an ergonomically designed handle and the silicone stop marker identifies the tips direction in the root canal.

M-Access® K-Files - 21mm

Sold in packs of 6

Item Number	Tip Size ISO	Assortment Packs of 6 Files
A12MA02100612	006	N/A
A12MA02100812	008	
A12MA02101012	010	
A12MA02101512	015	A12MA02190012 015 x1, 020 x1, 025 x1, 030 x1, 035 x1, 040 x1
A12MA02102012	020	
A12MA02102512	025	
A12MA02103012	030	
A12MA02103512	035	
A12MA02104012	040	A12MA02190112 045 x1, 050 x1, 055 x1, 060 x1, 0710 x1, 080 x1
A12MA02104512	045	
A12MA02105012	050	
A12MA02105512	055	
A12MA02106012	060	
A12MA02107012	070	A12MA02190212 090 x1, 100 x1, 110 x1, 120 x1, 130 x1, 140 x1
A12MA02108012	080	
A12MA02109012	090	
A12MA02110012	100	
A12MA02111012	110	
A12MA02112012	120	A12MA02190212 090 x1, 100 x1, 110 x1, 120 x1, 130 x1, 140 x1
A12MA02113012	130	
A12MA02114012	140	

M-Access® K-Files - 25mm

Sold in packs of 6

Item Number	Tip Size ISO	Assortment Packs of 6 Files
A12MA02500612	006	N/A
A12MA02500812	008	
A12MA02501012	010	
A12MA02501512	015	A12MA02590012 015 x1, 020 x1, 025 x1, 030 x1, 035 x1, 040 x1
A12MA02502012	020	
A12MA02502512	025	
A12MA02503012	030	
A12MA02503512	035	
A12MA02504012	040	A12MA02590112 045 x1, 050 x1, 055 x1, 060 x1, 0710 x1, 080 x1
A12MA02504512	045	
A12MA02505012	050	
A12MA02505512	055	
A12MA02506012	060	
A12MA02507012	070	A12MA02590212 090 x1, 100 x1, 110 x1, 120 x1, 130 x1, 140 x1
A12MA02508012	080	
A12MA02509012	090	
A12MA02510012	100	
A12MA02511012	110	
A12MA02512012	120	A12MA02590212 090 x1, 100 x1, 110 x1, 120 x1, 130 x1, 140 x1
A12MA02513012	130	
A12MA02514012	140	

M-Access® K-Files - 31mm

Sold in packs of 6

Item Number	Tip Size ISO	Assortment Packs of 6 Files
A12MA03100612	006	N/A
A12MA03100812	008	
A12MA03101012	010	
A12MA03101512	015	A12MA03190012 015 x1, 020 x1, 025 x1, 030 x1, 035 x1, 040 x1
A12MA03102012	020	
A12MA03102512	025	
A12MA03103012	030	
A12MA03103512	035	
A12MA03104012	040	A12MA03190112 045 x1, 050 x1, 055 x1, 060 x1, 0710 x1, 080 x1
A12MA03104512	045	
A12MA03105012	050	
A12MA03105512	055	
A12MA03106012	060	
A12MA03107012	070	A12MA03190212 090 x1, 100 x1, 110 x1, 120 x1, 130 x1, 140 x1
A12MA03108012	080	
A12MA03109012	090	
A12MA03110012	100	
A12MA03111012	110	
A12MA03112012	120	A12MA03190212 090 x1, 100 x1, 110 x1, 120 x1, 130 x1, 140 x1
A12MA03113012	130	
A12MA03114012	140	

M-Access® Hedstorem Files - 21mm

Sold in packs of 6

Item Number	Tip Size ISO	Assortment Packs of 6 Files
A16MA02100812	008	N/A
A16MA02101012	010	
A16MA02101512	015	
A16MA02102012	020	A12MA03190012 015 x1, 020 x1, 025 x1, 030 x1, 035 x1, 040 x1
A16MA02102512	025	
A16MA02103012	030	
A16MA02103512	035	
A16MA02104012	040	
A16MA02104512	045	A12MA03190112 045 x1, 050 x1, 055 x1, 060 x1, 0710 x1, 080 x1
A16MA02105012	050	
A16MA02105512	055	
A16MA02106012	060	
A16MA02107012	070	
A16MA02108012	080	A12MA03190212 090 x1, 100 x1, 110 x1, 120 x1, 130 x1, 140 x1
A16MA02109012	090	
A16MA02110012	100	
A16MA02111012	110	
A16MA02112012	120	
A16MA02113012	130	A12MA03190212 090 x1, 100 x1, 110 x1, 120 x1, 130 x1, 140 x1
A16MA02114012	140	

M-Access® Hedstorem Files - 25mm

Sold in packs of 6

Item Number	Tip Size ISO	Assortment Packs of 6 Files
A16MA02500812	008	N/A
A16MA02501012	010	
A16MA02501512	015	
A16MA02502012	020	A16MA02590012 015 x1, 020 x1, 025 x1, 030 x1, 035 x1, 040 x1
A16MA02502512	025	
A16MA02503012	030	
A16MA02503512	035	
A16MA02504012	040	
A16MA02504512	045	A16MA02590112 045 x1, 050 x1, 055 x1, 060 x1, 0710 x1, 080 x1
A16MA02505012	050	
A16MA02505512	055	
A16MA02506012	060	
A16MA02507012	070	
A16MA02508012	080	A16MA02590212 090 x1, 100 x1, 110 x1, 120 x1, 130 x1, 140 x1
A16MA02509012	090	
A16MA02510012	100	
A16MA02511012	110	
A16MA02512012	120	
A16MA02513012	130	A16MA02590212 090 x1, 100 x1, 110 x1, 120 x1, 130 x1, 140 x1
A16MA02514012	140	

M-Access® Hedstorem Files - 31mm

Sold in packs of 6

Item Number	Tip Size ISO	Assortment Packs of 6 Files
A16MA03100812	008	N/A
A16MA03101012	010	
A16MA03101512	015	
A16MA03102012	020	A16MA03190012 015 x1, 020 x1, 025 x1, 030 x1, 035 x1, 040 x1
A16MA03102512	025	
A16MA03103012	030	
A16MA03103512	035	
A16MA03104012	040	
A16MA03104512	045	A16MA03190112 045 x1, 050 x1, 055 x1, 060 x1, 0710 x1, 080 x1
A16MA03105012	050	
A16MA03105512	055	
A16MA03106012	060	
A16MA03107012	070	
A16MA03108012	080	A16MA03190212 090 x1, 100 x1, 110 x1, 120 x1, 130 x1, 140 x1
A16MA03109012	090	
A16MA03110012	100	
A16MA03111012	110	
A16MA03112012	120	
A16MA03113012	130	A16MA03190212 090 x1, 100 x1, 110 x1, 120 x1, 130 x1, 140 x1
A16MA03114012	140	

M-Access® brings Swiss made precision and quality to enhance your expertise with stainless steel handfiles.

M-Access® K-Reamer Files – 21mm

Sold in packs of 6

Item Number	Tip Size ISO	Assortment Packs of 6 Files
A11MA02100812	008	N/A
A11MA02101012	010	
A11MA02101512	015	
A11MA02102012	020	A11MA02190012 015 x1, 020 x1, 025 x1, 030 x1, 035 x1, 040 x1
A11MA02102512	025	
A11MA02103012	030	
A11MA02103512	035	
A11MA02104012	040	A11MA02190112 045 x1, 050 x1, 055 x1, 060 x1, 070 x1, 080 x1
A11MA02104512	045	
A11MA02105012	050	
A11MA02105512	055	
A11MA02106012	060	
A11MA02107012	070	
A11MA02108012	080	A11MA02190212 090 x1, 100 x1, 110 x1, 120 x1, 130 x1, 140 x1
A11MA02109012	090	
A11MA02110012	100	
A11MA02111012	110	
A11MA02112012	120	
A11MA02113012	130	
A11MA02114012	140	

M-Access® K-Reamer Files – 31mm

Sold in packs of 6

Item Number	Tip Size ISO	Assortment Packs of 6 Files
A11MA03100812	008	N/A
A11MA03101012	010	
A11MA03101512	015	
A11MA03102012	020	A11MA03190012 015 x1, 020 x1, 025 x1, 030 x1, 035 x1, 040 x1
A11MA03102512	025	
A11MA03103012	030	
A11MA03103512	035	
A11MA03104012	040	A11MA03190112 045 x1, 050 x1, 055 x1, 060 x1, 070 x1, 080 x1
A11MA03104512	045	
A11MA03105012	050	
A11MA03105512	055	
A11MA03106012	060	
A11MA03107012	070	
A11MA03108012	080	A11MA03190212 090 x1, 100 x1, 110 x1, 120 x1, 130 x1, 140 x1
A11MA03109012	090	
A11MA03110012	100	
A11MA03111012	110	
A11MA03112012	120	
A11MA03113012	130	
A11MA03114012	140	

M-Access® K-Flexofile – 18mm

Sold in packs of 6

Item Number	Tip Size ISO
BNCMAFL618015	015
BNCMAFL618020	020
BNCMAFL618025	025
BNCMAFL618030	030
BNCMAFL618035	035
BNCMAFL618040	040

M-Access® K-Reamer Files – 25mm

Sold in packs of 6

Item Number	Tip Size ISO	Assortment Packs of 6 Files
A11MA02500812	008	N/A
A11MA02501012	010	
A11MA02501512	015	
A11MA02502012	020	A11MA02590012 015 x1, 020 x1, 025 x1, 030 x1, 035 x1, 040 x1
A11MA02502512	025	
A11MA02503012	030	
A11MA02503512	035	
A11MA02504012	040	A11MA02590112 045 x1, 050 x1, 055 x1, 060 x1, 070 x1, 080 x1
A11MA02504512	045	
A11MA02505012	050	
A11MA02505512	055	
A11MA02506012	060	
A11MA02507012	070	
A11MA02508012	080	A11MA02590212 090 x1, 100 x1, 110 x1, 120 x1, 130 x1, 140 x1
A11MA02509012	090	
A11MA02510012	100	
A11MA02511012	110	
A11MA02512012	120	
A11MA02513012	130	
A11MA02514012	140	

M-Access® K-Flexofile – 21mm

Sold in packs of 6

Item Number	Tip Size ISO
BNCMAFL621015	015
BNCMAFL621020	020
BNCMAFL621025	025
BNCMAFL621030	030
BNCMAFL621035	035
BNCMAFL621040	040

M-Access® K-Flexofile – 25mm

Sold in packs of 6

Item Number	Tip Size ISO
BNCMAFL625015	015
BNCMAFL625020	020
BNCMAFL625025	025
BNCMAFL625030	030
BNCMAFL625035	035
BNCMAFL625040	040

M-Access® K-Flexofile – 31mm

Sold in packs of 6

Item Number	Tip Size ISO
BNCMAFL631015	015
BNCMAFL631020	020
BNCMAFL631025	025
BNCMAFL631030	030
BNCMAFL631035	035
BNCMAFL631040	040



CAVITY ACCESS AND SHAPING / GLIDE PATH

ProGlider®

Glide through quickly and easily

ProGlider® is the mechanised NiTi glide path system of choice for all dental practitioners using any endodontic shaping file system and looking for the most advanced glide path solution in terms of efficiency, simplicity and safety.

- Only one ProGlider® file is needed for creating a glide path respecting the root canal anatomy¹, allowing the dental practitioner to work faster than with manual files or alternative rotary glide path solutions
- ProGlider® is suitable for most root canals, including the highly curved ones²
- ProGlider® respects the root canal anatomy better than manual glide path files¹



ProGlider® File, 21mm	ProGlider® File, 25mm	ProGlider® File, 31mm
Sold in sterile packs of 3. A092322100103 ProGlider® File 21mm	Sold in sterile packs of 3 A092322500103 ProGlider® File 25mm	Sold in sterile packs of 3 A092323100103 ProGlider® File 31mm
Sold in sterile packs of 6 A092622100103 ProGlider® File 21mm	Sold in sterile packs of 6 A092622500103 ProGlider® File 25mm	Sold in sterile packs of 6 A092623100103 ProGlider® File 31mm



CAVITY ACCESS AND SHAPING / GLIDE PATH

PathFile®

A nickel-titanium rotary solution

PathFile® rotary instruments have been designed to create the glide path rapidly and safely, in place of stainless steel files. PathFile® offers many advantages compared to manual glide path solutions:

- The NiTi square section with 2% taper provides flexibility and high strength against cyclic fatigue
- The gradual increase of the tip diameters (ISO 013 – 016 – 019) facilitates the progression of the files without the need for strong axial pressure
- PathFile® substantially reduces the time spent for glide path compared to manual stainless steel files



PathFile® Rotary Glide Path Instruments – 25mm

Sold in a sterile blister of 6 files

Item Number	Tip Size ISO	Assortment Pack 1 sterile blister of 6 files
A001522501300	013	A001522590000 x2 of each 013, 016 and 019
A001522501600	016	
A001522501900	019	

PathFile® Rotary Glide Path Instruments – 21mm

Sold in a sterile blister of 6 files

Item Number	Tip Size ISO	Assortment Pack 1 sterile blister of 6 files
A001522101300	013	A001522190000 x2 of each 013, 016 and 019
A001522101600	016	
A001522101900	019	

PathFile® Rotary Glide Path Instruments – 31mm

Sold in a sterile blister of 6 files

Item Number	Tip Size ISO	Assortment Pack 1 sterile blister of 6 files
A001523101300	013	A001523190000 x2 of each 013, 016 and 019
A001523101600	016	
A001523101900	019	

¹ Alovisi M et al., 2016
² Alovisi M et al. 2016 et Kirchoff AL et al., 2015



CAVITY ACCESS AND SHAPING / GLIDE PATH

TruNatomy™ Glider

Creates an effective, reproducible glide path

The TruNatomy™ Glider optimises the glide path and allows for a smooth transition between the K-File and the TruNatomy™ Shaping Files. The TruNatomy™ Glider operates at a higher speed for greater cutting efficiency with less torque. With just 2 cutting edges, it encounters less resistance and thus requires less applied pressure, ensuring precision with increased ease of use. Thermal treatment provides greater flexibility with improved fatigue resistance.

- BSTTNMM421GLR TruNatomy™ Glider 4-files 21mm
- BSTTNMM425GLR TruNatomy™ Glider 4-files 25mm
- BSTTNMM431GLR TruNatomy™ Glider 4-files 31mm

Try me with...

TruNatomy™ Solution

Confirms the path for rotary files to follow –conforms and maintains the natural canal shape in complex anatomy.



CAVITY ACCESS AND SHAPING / GLIDE PATH



WaveOne® Gold Glider

Surf the canal with confidence

Optimise your shaping preparation with a single reciprocating glide path file that is part of the WaveOne® Gold solution. This new single glide path file has been designed in collaboration with a team of endodontist experts: Dr. E. Berrutti, Dr. G. Cantatore, Dr. A. Castellucci, Dr. S. Kuttler, Dr. W. Pertot, Dr. C. Ruddle, Dr. J. Webber, Dr. J. West.

WaveOne® Gold Glider:

- Respects the natural shape of the canal
- Increases patient safety with enhanced flexibility and resistance to cyclic fatigue*
- Sterile and ready for single use, which preserves cutting efficiency, reduces breakage and prevents cross contamination

The WaveOne® Gold Glider is only for use in reciprocating motion with compatible Dentsply Sirona motors. Helpful pre-programmed motor settings are available.



WaveOne® Gold Glider Reciprocating Glide Path Files

Sold in a sterile blister of 3 files

BSTW1GG321015	WaveOne® Gold Glider Glide Path Files	21mm
BSTW1GG325015	WaveOne® Gold Glider Glide Path Files	25mm
BSTW1GG331015	WaveOne® Gold Glider Glide Path Files	31mm

Sold in a sterile blister of 6 files

BSTW1GG621015	WaveOne® Gold Glider Glide Path Files	21mm
BSTW1GG625015	WaveOne® Gold Glider Glide Path Files	25mm
BSTW1GG631015	WaveOne® Gold Glider Glide Path Files	31mm

Try me with...

WaveOne® Gold Family

Complete your WaveOne® Gold solution with compatible WaveOne® Gold files, paper points, gutta-percha, GuttaCore® and ThermaFil®.



*compared to WaveOne®



CAVITY ACCESS AND SHAPING / SHAPING - HANDFILES



ProTaper®

For hand use

ProTaper® handfiles are for clinicians who want to start using NiTi files instead of the more traditional stainless steel files. Even for confident rotary users, they are useful for more difficult cases such as canals with great apical curvature. The silicone handles give better tactile sensation and greater working comfort.



ProTaper® For Hand Use File SX

Sold in packs of 6		
A041601910112	ProTaper® For Hand Use File SX	19mm

ProTaper® For Hand Use File S1

Sold in packs of 6		
A041602110112	ProTaper® For Hand Use File S1	21mm
A041602510112	ProTaper® For Hand Use File S1	25mm
A041603110112	ProTaper® For Hand Use File S1	31mm

ProTaper® For Hand Use File F3

Sold in packs of 6		
A041702110312	ProTaper® For Hand Use File F3	21mm
A041702510312	ProTaper® For Hand Use File F3	25mm
A041703110312	ProTaper® For Hand Use File F3	31mm

ProTaper® For Hand Use File S2

Sold in packs of 6		
A041602110212	ProTaper® For Hand Use File S2	21mm
A041602510212	ProTaper® For Hand Use File S2	25mm
A041603110212	ProTaper® For Hand Use File S2	31mm

ProTaper® For Hand Use File F4

Sold in packs of 6		
A041702110412	ProTaper® For Hand Use File F4	21mm
A041702510412	ProTaper® For Hand Use File F4	25mm
A041703110412	ProTaper® For Hand Use File F4	31mm

ProTaper® For Hand Use File F1

Sold in packs of 6		
A041702110112	ProTaper® For Hand Use File F1	21mm
A041702510112	ProTaper® For Hand Use File F1	25mm
A041703110112	ProTaper® For Hand Use File F1	31mm

ProTaper® For Hand Use File F5

Sold in packs of 6		
A041702110512	ProTaper® For Hand Use File F5	21mm
A041702510512	ProTaper® For Hand Use File F5	25mm
A041703110512	ProTaper® For Hand Use File F5	31mm

ProTaper® For Hand Use File F2

Sold in packs of 6		
A041702110212	ProTaper® For Hand Use File F2	21mm
A041702510212	ProTaper® For Hand Use File F2	25mm
A041703110212	ProTaper® For Hand Use File F2	31mm

ProTaper® For Hand Use Assortment Kits

Sold in packs of 6		
A041802190112	ProTaper® For Hand Use	21mm File Assortment
A041802590112	ProTaper® For Hand Use	25mm File Assortment
A041803190112	ProTaper® For Hand Use	31mm File Assortment



CAVITY ACCESS AND SHAPING / SHAPING - HANDFILES

Spiro® Colorinox

Short barbed nervobroach

- 21mm
- ISO Color-Coded
- Box of 10

A004B02102001	Nervbroach Color:020
A004B02102501	Nervbroach Color:025
A004B02103001	Nervbroach Color:030
A004B02103501	Nervbroach Color:035
A004B02104001	Nervbroach Color:040
A004B02105001	Nervbroach Color:050
A004B02106001	Nervbroach Color:060
A004B02190001	Nervbroach Color:20-60



CAVITY ACCESS AND SHAPING / SHAPING - ROTARY

TruNatomy™

True, Natural, Anatomy - A solution that adapts to you, leveraging your expertise

Our latest root canal treatment innovation, TruNatomy™, combines Swiss precision with advanced engineering to offer improved performance¹ whilst adhering to a philosophy focused on dentin preservation. Rotary files, corresponding gutta percha points, paper points and an irrigation needle, combine to make a comprehensive solution that respects the natural anatomy of the canal.

With a unique set of features, TruNatomy™ offers a host of benefits including:

- Better performance and more space for debridement and debris removal thanks to a new file design with an enhanced off-centered cross section and a slimmer NiTi wire. Its higher speed of operation provides greater efficiency with less torque.
- Respect of the natural tooth anatomy thanks to its superior canal centering ability. The instrument adjusts to the canal (and not the other way around).
- Preservation of the tooth integrity achieved by the combination of the file geometry, the slim wire and its increased flexibility together with a shorter 9.5mm handle that perfectly fits micro-head handpieces, allowing for efficient root canal treatments without straight line access, only removing dentin where clinically needed.
- A smooth experience with files that progress down the canal with almost no screwing in effect, giving you a full sense of control during the whole preparation.
- Simplicity since this single-file shaping system (following the use of the TruNatomy™ Orifice Modifier and TruNatomy™ Glide Path) is an easy to learn rotary endo solution complemented by matching paper points, Conform Fit™ gutta-percha points and a flexible irrigation needle.

Files:

BSTTNMM416OMD	TruNatomy™ Orifice Modifier	4-files 16mm
BSTTNMM421GLR	TruNatomy™ Glider	4-files 21mm
BSTTNMM425GLR	TruNatomy™ Glider	4-files 25mm
BSTTNMM431GLR	TruNatomy™ Glider	4-files 31mm
BSTTNMM421SML	TruNatomy™ Small	4-files 21mm
BSTTNMM425SML	TruNatomy™ Small	4-files 25mm
BSTTNMM431SML	TruNatomy™ Small	4-files 31mm
BSTTNMM421PRM	TruNatomy™ Prime	4-files 21mm
BSTTNMM425PRM	TruNatomy™ Prime	4-files 25mm
BSTTNMM431PRM	TruNatomy™ Prime	4-files 31mm
BSTTNMM421MED	TruNatomy™ Medium	4-files 21mm
BSTTNMM425MED	TruNatomy™ Medium	4-files 25mm
BSTTNMM431MED	TruNatomy™ Medium	4-files 31mm
BSTTNMM321SQC	TruNatomy™ Sequence	3-files 21mm
BSTTNMM325SQC	TruNatomy™ Sequence	3-files 25mm
BSTTNMM331SQC	TruNatomy™ Sequence	3-files 31mm
BSTTNMM521AST	TruNatomy™ Assortment	5-files 16-21mm
BSTTNMM525AST	TruNatomy™ Assortment	5-files 16-25mm
BSTTNMM531AST	TruNatomy™ Assortment	5-files 16-31mm

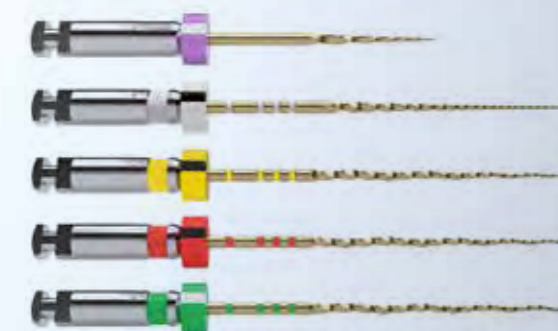

Solution Kit:

- BOOTNMM000KIT
- 5x TruNatomy™ Sequence 3-Files 25mm
 - 1x TruNatomy™ Orifice Modifier 3-Files 16mm
 - 1x TruNatomy™ Glider 3-Files 25mm
 - 1x TruNatomy™ Small 3-Files 25mm
 - 1x TruNatomy™ Prime 3-Files 25mm
 - 1x TruNatomy™ Medium 3-Files 25mm
 - 1x TruNatomy™ Conform Fit™ Gutta Percha Assortment
 - 1x TruNatomy™ Paper Points Assortment
 - 9x TruNatomy™ Irrigation Needle 30 Gauge



Try me with...

TruNatomy™ Solution

The true benefits of TruNatomy™ are shown when used together with the corresponding gutta percha points, paper points and the innovative irrigation needle.



CAVITY ACCESS AND SHAPING / SHAPING - ROTARY 

ProTaper Next®

Flexible performance

ProTaper Next® is the successor to the ProTaper® Universal system, which has been the gold standard in endodontics for many years. It is an efficient* solution for endo practitioners seeking a versatile, flexible system that will handle the vast majority of root canal treatments.

Next generation technology

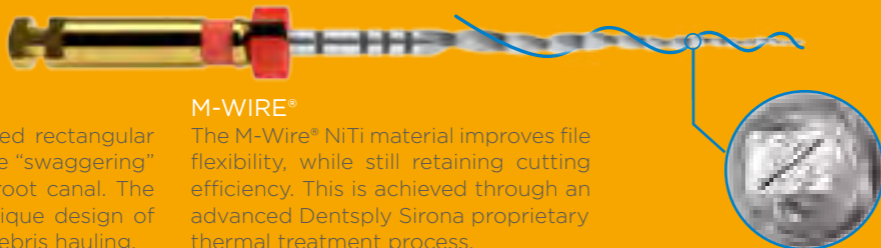

Swagging Effect
ProTaper Next's innovative off-centred rectangular cross section gives the file a snake-like "swagging" movement as it moves through the root canal. The off-centred cross section and the unique design of the file generate enlarged space for debris hauling.

M-WIRE®
The M-Wire® NiTi material improves file flexibility, while still retaining cutting efficiency. This is achieved through an advanced Dentsply Sirona proprietary thermal treatment process.



ProTaper Next® X1 File

(Apex 017 and Apical taper of 04)
Sold in a sterile blister of 3 files

A080322100103	ProTaper Next® X1 File	21mm
A080322500103	ProTaper Next® X1 File	25mm
A080323100103	ProTaper Next® X1 File	31mm

Sold in a sterile blister of 6 files

A080022100103	ProTaper Next® X1 File	21mm
A080022500103	ProTaper Next® X1 File	25mm
A080023100103	ProTaper Next® X1 File	31mm



ProTaper Next® X2 File

(Apex 025 and Apical taper of 06)
Sold in a sterile blister of 3 files

A080322100203	ProTaper Next® X2 File	21mm
A080322500203	ProTaper Next® X2 File	25mm
A080323100203	ProTaper Next® X2 File	31mm

Sold in a sterile blister of 6 files

A080022100203	ProTaper Next® X2 File	21mm
A080022500203	ProTaper Next® X2 File	25mm
A080023100203	ProTaper Next® X2 File	31mm



ProTaper Next® X3 File

(Apex 030 and Apical taper of 07)
Sold in a sterile blister of 3 files

A080322100303	ProTaper Next® X3 File	21mm
A080322500303	ProTaper Next® X3 File	25mm
A080323100303	ProTaper Next® X3 File	31mm

Sold in a sterile blister of 6 files

A080022100303	ProTaper Next® X3 File	21mm
A080022500303	ProTaper Next® X3 File	25mm
A080023100303	ProTaper Next® X3 File	31mm

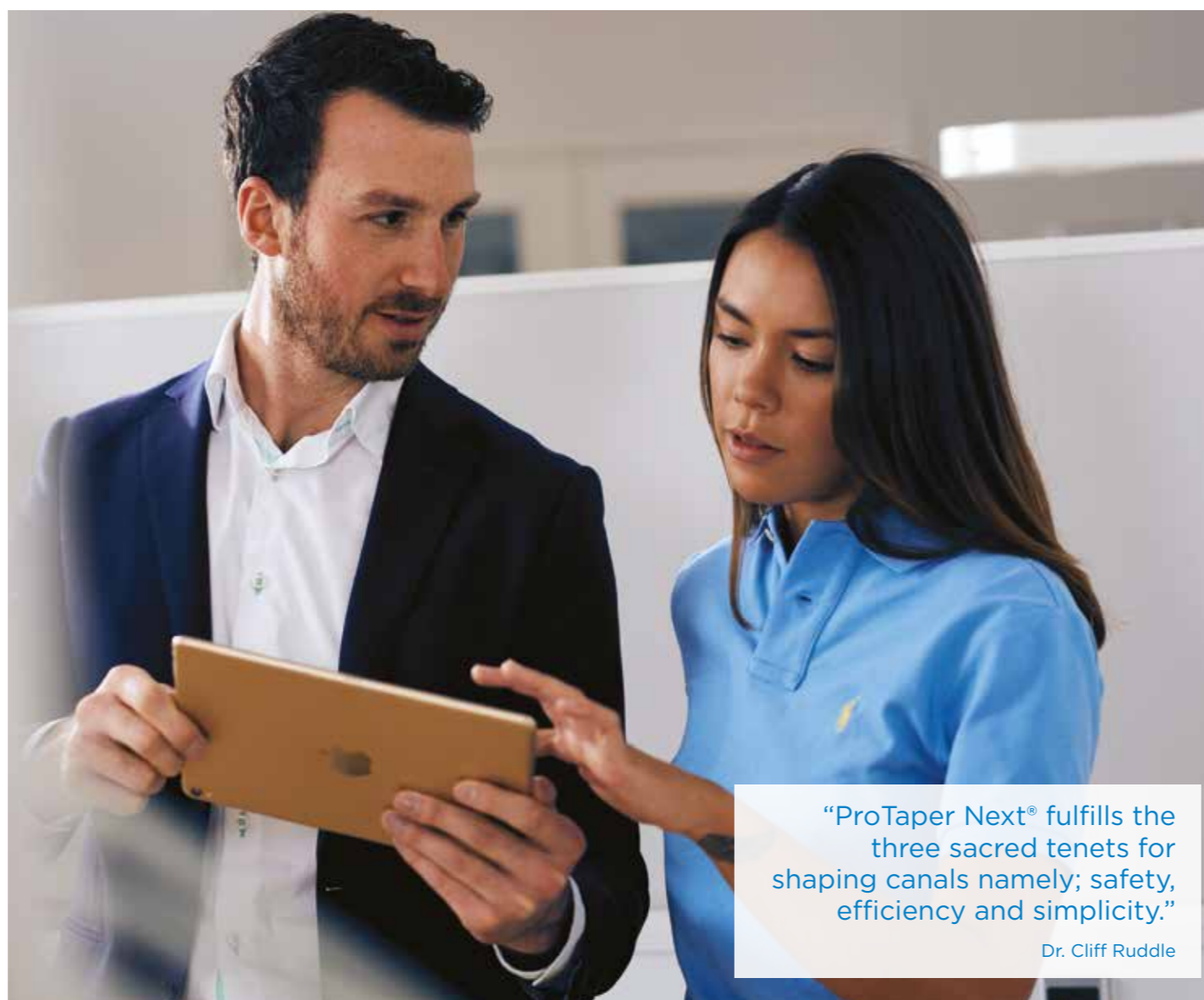

"ProTaper Next® fulfills the three sacred tenets for shaping canals namely; safety, efficiency and simplicity."

Dr. Cliff Ruddle

ProTaper Next®:

- **Covers more difficult clinical cases*** - The unique swagging movement and the greater flexibility of the ProTaper Next® files make it possible to shape more severely curved narrow canals than what was possible before with most NiTi systems on the market
- **Brings improved safety*** - The risk of file breakage is significantly decreased, at the same time, respect of the original root canal anatomy is greatly improved. Instrument performance and patient safety are essential to good endodontics
- **Shortens the shaping time*** - A shorter clinical sequence means that less time is spent changing instruments. The high cutting efficiency also reduces the shaping time. For the dentist, this is valuable time that can be used for other procedures, such as irrigation
- **Improves debris removal** - The unique off-centred rectangular cross section gives the file a snake-like swagging movement and provides enlarged space for the debris

* Source: Internal lab data

Try me with...

ProGlider®

Start your ProTaper Next® endo procedure off in the right way by creating your glide path with ProGlider®. The most advanced glide path solution in terms of efficiency, simplicity and safety.



ProTaper Next® X4 File

(Apex 040 and Apical taper of 06)
Sold in a sterile blister of 3 files

A080322100403	ProTaper Next® X4 File	21mm
A080322500403	ProTaper Next® X4 File	25mm
A080323100403	ProTaper Next® X4 File	31mm

Sold in a sterile blister of 6 files

A080022100403	ProTaper Next® X4 File	21mm
A080022500403	ProTaper Next® X4 File	25mm
A080023100403	ProTaper Next® X4 File	25mm



ProTaper Next® X5 File

(Apex 050 and Apical taper of 06)
Sold in a sterile blister of 3 files

A080322100503	ProTaper Next® X5 File	21mm
A080322500503	ProTaper Next® X5 File	25mm
A080323100503	ProTaper Next® X5 File	31mm

Sold in a sterile blister of 6 files

A080022100503	ProTaper Next® X5 File	21mm
A080022500503	ProTaper Next® X5 File	25mm
A080023100503	ProTaper Next® X5 File	31mm

ProTaper Next® Access Opener File

(Apex 019 and Apical taper of 035)
Sold in a sterile blister of 3 files

A080321900A03	ProTaper Next® XA	19mm
---------------	-------------------	------

Sold in a sterile blister of 6 files

A080021900A03	ProTaper Next® XA	19mm
---------------	-------------------	------



ProTaper Next® X1-X3 Assortment Pack

Sold in a sterile blister of 3 files

A08032219A003	ProTaper Next® X1-X3 Assortment Pack	21mm
A08032259A003	ProTaper Next® X1-X3 Assortment Pack	25mm
A08032319A003	ProTaper Next® X1-X3 Assortment Pack	31mm

Sold in a sterile blister of 6 files

A08002219A003	ProTaper Next® X1-X3 Assortment Pack	21mm
A08002259A003	ProTaper Next® X1-X3 Assortment Pack	25mm
A08002319A003	ProTaper Next® X1-X3 Assortment Pack	31mm

* Elnaghy, A. M., & Elsaka, S. E. (2014). Assessment of the mechanical properties of ProTaper Next nickel-titanium rotary files. Journal of endodontics, 40(11), 1830-1834.



CAVITY ACCESS AND SHAPING / SHAPING - ROTARY



ProTaper Gold®

The same winning technique
with greater flexibility

ProTaper Gold® features the same simplicity and smoothly tapered shapes you know and trust from ProTaper® Universal. Developed with proprietary advanced metallurgy, ProTaper Gold® rotary files offer greater flexibility for ProTaper® performance that's better than ever.

- +24% increased flexibility*
- x2.6 greater resistance to cyclic fatigue**
- Shorter 11mm handle

ProTaper Gold® Assortment Kits

Sold in sterile packs of 6

A0409221G0103	ProTaper Gold® SX, S1, S2, F1, F2 and F3 21mm
A0409225G0103	ProTaper Gold® SX, S1, S2, F1, F2 and F3 25mm
A0409231G0103	ProTaper Gold® SX, S1, S2, F1, F2 and F3 31mm

ProTaper Gold® Shaping File SX

Sold in sterile packs of 6

A0410219G0103	ProTaper Gold® Shaping File SX	19mm
---------------	--------------------------------	------

ProTaper Gold® Shaping File S1

Sold in sterile packs of 6

A0410221G0103	ProTaper Gold® Shaping File S1	21mm
A0410225G0103	ProTaper Gold® Shaping File S1	25mm
A0410231G0103	ProTaper Gold® Shaping File S1	31mm

ProTaper Gold® Shaping File S2

Sold in sterile packs of 6

A0410221G0203	ProTaper Gold® Shaping File S2	21mm
A0410225G0203	ProTaper Gold® Shaping File S2	25mm
A0410231G0203	ProTaper Gold® Shaping File S2	31mm

ProTaper Gold® Finishing File F1

Sold in sterile packs of 6

A0411221G010	ProTaper Gold® Finishing File F1	21mm
A0411225G0103	ProTaper Gold® Finishing File F1	25mm
A0411231G0103	ProTaper Gold® Finishing File F1	31mm

ProTaper Gold® Finishing File F2

Sold in sterile packs of 6

A0411221G0203	ProTaper Gold® Finishing File F2	21mm
A0411225G0203	ProTaper Gold® Finishing File F2	25mm
A0411231G0203	ProTaper Gold® Finishing File F2	31mm

ProTaper Gold® Finishing File F3

Sold in sterile packs of 6

A0411221G0303	ProTaper Gold® Finishing File F3	21mm
A0411225G0303	ProTaper Gold® Finishing File F3	25mm
A0411231G0303	ProTaper Gold® Finishing File F3	31mm

ProTaper Gold® Finishing File F4

Sold in sterile packs of 6

A0411221G0403	ProTaper Gold® Finishing File F4	21mm
A0411225G0403	ProTaper Gold® Finishing File F4	25mm
A0411231G0403	ProTaper Gold® Finishing File F4	31mm

ProTaper Gold® Finishing File F5

Sold in sterile packs of 6

A0411221G0503	ProTaper Gold® Finishing File F5	21mm
A0411225G0503	ProTaper Gold® Finishing File F5	25mm
A0411231G0503	ProTaper Gold® Finishing File F5	31mm

* Average value for ProTaper Gold® compared to ProTaper® Universal. Based on internal testing. Data on file.

** For ProTaper Gold® F3 finishing file. Average cyclic fatigue resistance of the ProTaper Gold® system is x 2.4 superior to the ProTaper® Universal system. Based on internal testing. Data on file.



CAVITY ACCESS AND SHAPING / SHAPING - ROTARY



ProFile®

Flexible and safe instrumentation



ProFile® are NiTi rotary instruments that feature multiple tapers from 2-8% and offer maximal security due to their non-cutting radical land flute design and u-shaped cross-section. The high flexibility of these finishing files allows for soft canal shaping, especially in the apical third.

ProFile® Orifice Shapers - 19mm, 3 Bands

Sold in packs of 6

Item Number	Tip Size ISO	Assortment Packs of 6
A035921900100	.05/20	A035921990000 1x of each size
A035921900200	.06/30	
A035921900300	.06/40	
A035921900400	.07/50	
A035921900500	.08/60	
A035921900600	.08/80	

ProFile® .06 Tapers - 21mm, 2 Bands

Sold in packs of 6

Item Number	Tip Size ISO	Assortment Packs of 6
A034522101512	015	A034522190012 1x of each size
A034522102012	020	
A034522102512	025	
A034522103012	030	
A034522103512	035	
A034522104012	040	

ProFile® .06 Tapers - 25mm, 2 Bands

Sold in packs of 6

Item Number	Tip Size ISO	Assortment Packs of 6
A034522501512	015	A034522590012 1x of each size
A034522502012	020	
A034522502512	025	
A034522503012	030	
A034522503512	035	
A034522504012	040	

ProFile® .04 Tapers - 21mm, 1 Band

Sold in packs of 6

Item Number	Tip Size ISO	Assortment Packs of 6
A011N22101512	015	A011N22190012 015 x1, 020 x1, 025 x1, 030 x1, 035 x1, 040 x1
A011N22102012	020	
A011N22102512	025	
A011N22103012	030	
A011N22103512	035	
A011N22104012	040	
A011N22104500	045	A011N22190700 045 x2, 060 x2, 090 x2
A011N22106000	060	
A011N22109000	090	

ProFile® .04 Tapers - 25mm, 1 Band

Sold in packs of 6

Item Number	Tip Size ISO	Assortment Packs of 6
A011N22501512	015	A011N22590012 015 x1, 020 x1, 025 x1, 030 x1, 035 x1, 040 x1
A011N22502012	020	
A011N22502512	025	
A011N22503012	030	
A011N22503512	035	
A011N22504012	040	
A011N22504500	045	A011N22590700 045 x2, 060 x2, 090 x2
A011N22506000	060	
A011N22509000	090	

ProFile® .04 Tapers - 31mm, 1 Band

Sold in packs of 6

Item Number	Tip Size ISO	Assortment Packs of 6
A011N23101500	015	A011N23190000 015 x1, 020 x1, 025 x1, 030 x1, 035 x1, 040 x1
A011N23102000	020	
A011N23102500	025	
A011N23103000	030	
A011N23103500	035	
A011N23104000	040	
A011N23104500	045	A011N23190700 045 x2, 060 x2, 090 x2
A011N23106000	060	
A011N23109000	090	

ProFile® .02 Tapers - 21mm

Sold in packs of 6

Item Number	Tip Size ISO	Assortment Packs of 6
A034422101500	015	A034422190000 015 x1, 020 x1, 025 x1, 030 x1, 035 x1, 040 x1
A034422102000	020	
A034422103000	025	
A034422103500	030	
A034422103500	035	
A034422104000	040	

ProFile® .02 Tapers - 25mm

Sold in packs of 6

Item Number	Tip Size ISO	Assortment Packs of 6
A034422501500	015	A034422590000 015 x1, 020 x1, 025 x1, 030 x1, 035 x1, 040 x1
A034422502000	020	
A034422502500	025	
A034422503000	030	
A034422503500	035	
A034422504000	040	



CAVITY ACCESS AND SHAPING / SHAPING - ROTARY



WaveOne® Gold

Surf the canal with confidence

WaveOne® Gold is engineered with the latest reciprocating technology, and the single file simplicity of WaveOne® is now enhanced in WaveOne® Gold. Made with advanced metallurgy, it is the next generation of performance from Dentsply Sirona. WaveOne® Gold brings to the endodontic procedure a metallurgically advanced single-file technique for shaping canals. The tip diameters, tapers, and the cross-section have been optimised to produce a file that really improves safety, efficiency and flexibility when preparing canals. WaveOne® Gold takes simplicity and treatment success to another level.



- Optimised tip
- Variable taper
- Gold thermal treatment
- Evolving cross-section
- Reciprocating motion

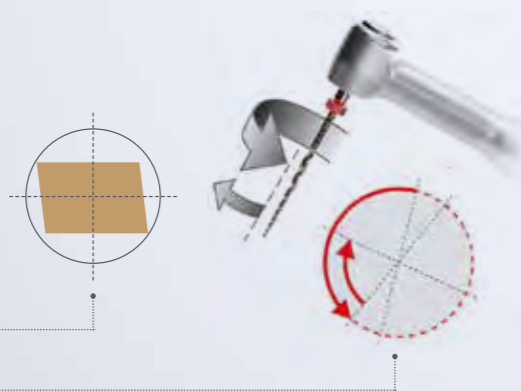

WaveOne® Gold:

Reinforces patient safety

- The primary WaveOne® Gold file is 50% more resistant to cyclic fatigue than the WaveOne® Primary file
- Reduced screwing effect* compared to standard rotary systems

Covers a wider** range of canal morphologies

- Enhanced file flexibility thanks to the Gold technology
- Extended size range (Small, Primary, Medium, Large)

Shortens the shaping time

- Takes the cutting efficiency to a higher level
- A single file per treatment also translates into time savings for canal shaping and irrigation

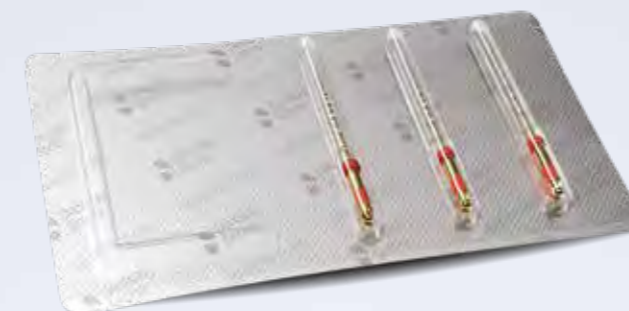

WaveOne® Gold Blister Sequence

Sold in a sterile blister of 3 files
BSTWIGS325AST
WaveOne® Gold Blister Sequence 25mm

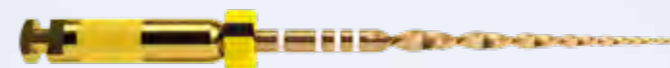

WaveOne® Gold Reciprocation Shaping Files - Small

(Apex 020 and Variable taper of 07)
Sold in a sterile blister of 3 files
A0753221GOS03 WaveOne® Gold Small File 21mm
A0753225GOS03 WaveOne® Gold Small File 25mm
A0753231GOS03 WaveOne® Gold Small File 31mm
Sold in a sterile blister of 6 files
A0756221GOS03 WaveOne® Gold Small File 21mm
A0756225GOS03 WaveOne® Gold Small File 25mm
A0756231GOS03 WaveOne® Gold Small File 31mm

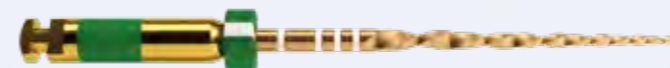

WaveOne® Gold Reciprocation Shaping Files - Medium

(Apex 035 and Variable taper of 06)
Sold in a sterile blister of 3 files
A0753221GOM03 WaveOne® Gold Medium File 21mm
A0753225GOM03 WaveOne® Gold Medium File 25mm
A0753231GOM03 WaveOne® Gold Medium File 31mm
Sold in a sterile blister of 6 files
A0756221GOM03 WaveOne® Gold Medium File 21mm
A0756225GOM03 WaveOne® Gold Medium File 25mm
A0756231GOM03 WaveOne® Gold Medium File 31mm

WaveOne Gold Reciprocating File Assortment Pack

Sold in a sterile blister of 4 files
(1x Small/Primary/Medium/Large)
A0754221G9A03 WaveOne® Gold Assortment Pack 21mm
A0754225G9A03 WaveOne® Gold Assortment Pack 25mm
A0754231G9A03 WaveOne® Gold Assortment Pack 31mm



'I want files I can count on, and that's why I use the WaveOne® Gold products. The files are dependable and consistently provide me with a great outcome that I expect'

Dr. Zayneb Bahrani, Illinois, USA

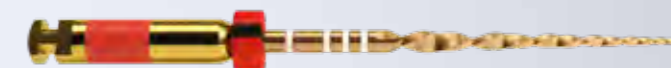

WaveOne® Gold Reciprocation Shaping Files - Primary

(Apex 025 and Variable taper of 07)
Sold in a sterile blister of 3 files
A0753221GOP03 WaveOne® Gold Primary File 21mm
A0753225GOP03 WaveOne® Gold Primary File 25mm
A0753231GOP03 WaveOne® Gold Primary File 31mm
Sold in a sterile blister of 6 files
A0756221GOP03 WaveOne® Gold Primary File 21mm
A0756225GOP03 WaveOne® Gold Primary File 25mm
A0756231GOP03 WaveOne® Gold Primary File 31mm



WaveOne® Gold Reciprocation Shaping Files - Large

(Apex 045 and Variable taper of 05)
Sold in a sterile blister of 3 files
A0753221GOL03 WaveOne® Gold Large File 21mm
A0753225GOL03 WaveOne® Gold Large File 25mm
A0753231GOL03 WaveOne® Gold Large File 31mm
Sold in a sterile blister of 6 files
A0756221GOL03 WaveOne® Gold Large File 21mm
A0756225GOL03 WaveOne® Gold Large File 25mm
A0756231GOL03 WaveOne® Gold Large File 31mm

Root Canal Treatment Solution with WaveOne® Gold

- BOORCTSWIGKIT
- 2x blisters of WaveOne® Gold Glider
 - 1x blister of WaveOne® Gold Small
 - 2x blisters of WaveOne® Gold Primary
 - 2x blisters of WaveOne® Gold Medium
 - 1x blister of WaveOne® Gold Large
 - 1x box of WaveOne® Conform Fit™ Gutta-Percha Assortment
 - 1x box of WaveOne® Paper Points Primary
 - 1x box of AH Plus Jet® Starter Kit

Try me with...

WaveOne® Gold Family

Complete your WaveOne® Gold solution with compatible WaveOne® Gold Glider files, paper points, gutta-percha, GuttaCore® and ThermoFil®.



*Internal laboratory testing results
**Compared to WaveOne®



CAVITY ACCESS AND SHAPING / RETREATMENT - ROTARY



ProTaper®

Retreatment files

Retreatment files have been specifically designed to remove obturation material from the root canal. There are three retreatment files: D1, D2 and D3, one for each third of the canal. D1 has a cutting tip for effective entrance into the obturation material in the coronal third. D2 and D3 are used in the mid and apical thirds of the canal respectively and have non-active tips that have been designed to closely respect the path of the canal. The tapers of these three files match the diameters of average root canals and the handles are only 11mm long, improving visibility.

ProTaper® Retreatment Files

Sold in packs of 6

A141021600112	ProTaper® Retreatment File D1	16mm
A141021800112	ProTaper® Retreatment File D2	18mm
A141022200112	ProTaper® Retreatment File D3	22mm
A141220090012	ProTaper® Assortment Kit (contains D1 x2, D2 x2, D3 x2)	



Ensure reliable adhesion and tight coronal seals in high C-factor cavities with SDR® Plus

Endodontic cavities are particularly challenging for bulk fill composites, as most are very deep Class I like cavities. This maximises shrinkage stress potential due to the large surface area for the filling material to bond to, indicated by a high C-factor. Studies indicate that when high C-factor cavities are filled in bulk, the choice of the composite is an important element to avoiding adhesive debonding.²



SDR® Plus with SDR® technology can deal with high C-factor cavities thanks to:

- 1 60% lower shrinkage stress³ than competing composites
- 2 Unique self-levelling properties
- 3 Sufficient mechanical strength for posterior restorations
- 4 High micro tensile bond strength
- 5 Excellent adhesion to the cavity floor

Pre-test failures [%] during micro tensile bond strength testing to cavity floor

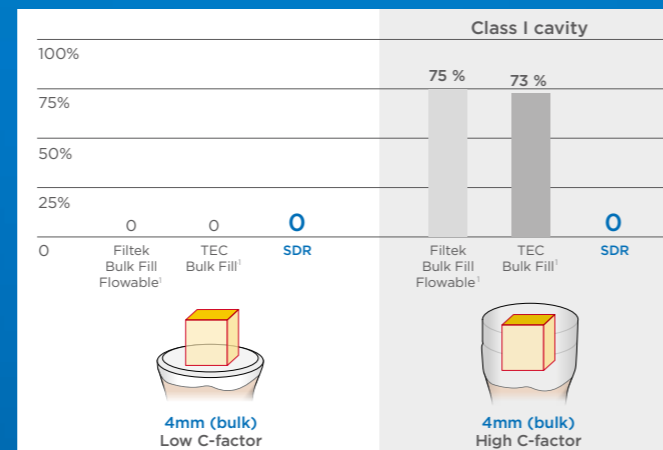

¹ Not a registered trademark of Dentsply Sirona

² Bulk-Filling of high C-Factor posterior cavities: Effect on adhesion to cavity-bottom dentin (Van Ende et al. Dental Materials 29 (2013): 269-277)

³ Internal Data. Available upon request, see contact details.



CAVITY ACCESS AND SHAPING / MOTORS

X-Smart IQ®

Touch the future today

A continuous and reciprocating motion cordless motor controlled by an Apple iOS® application

In one cordless handpiece, you get a full-treatment solution that supports you through every step of your endodontic process, from patient education to treatment data. Through a custom iOS® app, a digital ecosystem is created that allows synchronisation of future products and immediate updates. Move freely and easily between operatories utilising the easily portable, ergonomically-designed cordless handpiece.

The X-Smart IQ® provides a complete solution that is designed to:

- Give you more freedom when shaping with a slim, well-balanced and cordless handpiece
- Support you throughout the endodontic treatment with RTTM™ (Real-Time Torque Monitoring), display and calibration via the iOS® app
- Prepare your practice for the future via updates and simple and easy connectivity with future products

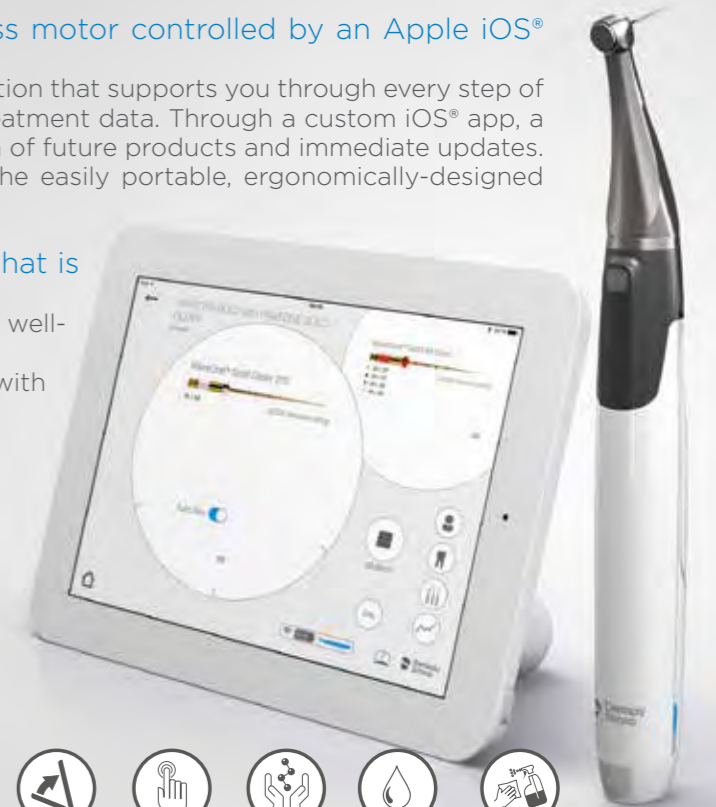

X-Smart IQ® Endodontic Handpiece Set

A105480000000

- X-Smart IQ® Motor Handpiece
- X-Smart IQ® Contra-Angle

X-Smart IQ® Basic Starter Kit

A105400000000

- X-Smart IQ® Motor Handpiece
- X-Smart IQ® Contra-Angle
- X-Smart IQ® iPad Mini® Protective Case

X-Smart® TruNatomy™ Starter Kit

X-Smart IQ® Motor Handpiece

- X-Smart IQ® Contra-Angle
- X-Smart IQ® iPad Mini
- X-Smart IQ® iPad Mini Protective Case
- 8x blisters TruNatomy™ Assortment: Orifice Modifier to Medium Shaping File, 25mm - 30 files

X-Smart IQ® WaveOne® Gold Starter Kit

A105410000000

- X-Smart IQ® Motor Handpiece
- X-Smart IQ® Contra-Angle
- X-Smart IQ® iPad Mini® Protective Case
- 5x Blisters WaveOne® Gold Primary, 25mm (15 files)
- 4x Blisters WaveOne® Gold Assortment, 25mm (16 files)
- 1x Blisters ProGlider®, 25mm (3 files)

X-Smart IQ® ProTaper Next® Starter Kit

A105420000000

- X-Smart IQ® Motor Handpiece
- X-Smart IQ® Contra-Angle
- X-Smart IQ® iPad Mini® Protective Case
- 10x Blisters ProTaper Next® Assortment X1-X3, 25mm (30 files)
- 1x Blisters ProGlider®, 25mm (3 files)

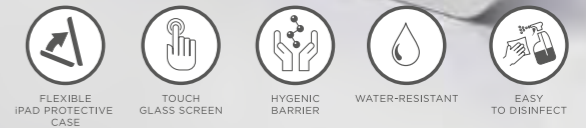

X-Smart IQ® ProTaper Gold® Starter Kit

A105430000000

- X-Smart IQ® Motor Handpiece
- X-Smart IQ® Contra-Angle
- X-Smart IQ® iPad Mini® Protective Case
- 1x Blisters ProTaper Gold® Assortment (6 files)
- 1x Blisters ProTaper Gold® S1 (6 files)
- 1x Blisters ProTaper Gold® S2 (6 files)
- 1x Blisters ProTaper Gold® F1 (6 files)
- 1x Blisters ProTaper Gold® F2 (6 files)
- 1x Blisters ProGlider® 25mm (3 files)

X-Smart IQ® Spare Parts and Accessories

- | | |
|---------------|---|
| A105100000000 | X-Smart IQ® Contra-Angle |
| A105800000000 | X-Smart IQ® Handpiece Sleeves |
| A105300000000 | X-Smart IQ® Universal Charger |
| A105820000000 | X-Smart IQ® Contra-Angle Cleaning Adapter |
| A105810000000 | X-Smart IQ® Spray Adapter |
| A105210000000 | X-Smart IQ® Handpiece Support and Case |
| B00IQ00STA000 | Endo IQ® iPad Stand |

Try me with...

Propex IQ®

When used with the X-Smart IQ® and the Endo IQ® App, the Propex IQ® allows you to efficiently and visually monitor file progression whilst shaping the canal at the same time.



CAVITY ACCESS AND SHAPING / **MOTORS**

X-Smart® Plus

Everything you like about X-Smart® with a plus

The X-Smart® Plus micro-motor is a simple and easy to use unit designed for general dental practitioners performing root canal treatments with the reciprocating, single file technique or traditional continuous rotation file system. It enables the practitioner to fully focus on the patient and treatment due to its simplicity of use, as well as the excellent visibility access with the miniature contra-angle attachment.



- **Pre-programmed**
For different reciprocating and continuous file systems – choose your preferred system at a single glance.
- **User-friendly interface**
With 'click and go' navigation and button controls dedicated to each function.
- **No foot pedal**
On/off button on the motor handpiece.
- **Excellent visibility**
And access due to the miniature contra-angle.

X-Smart® Plus and WaveOne® Gold Kit

A103581000000

- X-Smart® Plus Endo Motor
- 5 blisters WaveOne® Gold Primary, 25mm (15 files)
- 4 Blisters WaveOne® Gold Assortment, 25mm (16 files)
- 1 Bliester ProGlider®, 25mm (3 files)
- WaveOne® Gold Clinical Procedure Card

X-Smart® Plus and ProTaper Next® Kit

A103541000000

- X-Smart® Plus Endo Motor
- 10 Blisters ProTaper Next® Assortment X1-X3, 25mm (30 files)
- 1 blister ProGlider®, 25mm (3 files)
- ProTaper Next® Clinical Procedure Card

X-Smart® Plus 6:1 Contra-Angle

A103300000000



X-Smart® Plus Cleaning Adaptor

A103400000200

Cleaning and Maintenance Unit Adaptor



X-Smart® Plus

A1032000000000

Endo Motor with Contra-Angle and Universal AC Adaptor

CAVITY ACCESS AND SHAPING / **ACCESSORIES**

Accessories

For easy identification and handling of instruments during the surgical procedure

A041300000300
A041300000400ProTaper® Sequencer Treatment (black)
ProTaper® Sequencer Re-Treatment (yellow) 

(Files not included)



Clean Stand

Sterilisable Plastic Box

- | | |
|---------------|--|
| A268P00000000 | Clean Stand |
| A268P00000200 | Clean Stand - Large |
| A268S00000000 | Clean Stand Sponges (25 per box) |
| A268S00000200 | Clean Stand Sponges - Large (25 per box) |
| A265P00000000 | Endo-Stand, Aluminium, Blue Insert |
| A018400000000 | Endo M Block |
| A019700000100 | Silicone Stops Dispenser (200 per box) |
| E024800000500 | Sterilisable Plastic Box 5 Empty |
| E024800000800 | Sterilisable Plastic Box 8 Endo |



IRRIGATION AND OBTURATION / IRRIGATION

Endoactivator®

An easy to use and safe solution to activate your irrigation

The Endoactivator® is designed to safely and vigorously energise intracanal irrigants during endodontic treatment. Safe, effective and simple, the Endoactivator® helps to improve debridement and the disruption of the smear layer of biofilm.

Endoactivator® Tips

- Easy snap-on/snap-off design
- Strong, flexible, medical-grade polymer composition
- Colour-coded by size
- 22mm lengths with depth gauge rings at 18, 19 and 20mm

Handpiece/Driver:

- Contra-angled design for easy access to posterior teeth
- 3-speed sonic motor provides options of 2.000, 6.000 and 10.000cpm
- Ergonomic, cordless, and battery operated handpiece.



Designed by Dr. Clifford Ruddle, DDS, Dr. Robert Sharp, DDS and Dr. Pierre Machtou, DDS.

Activate your endodontic solutions today with this easy to use technology.

Endoactivator® System Kit

- A0911000000000
- 1x Endoactivator® Handpiece/Driver (battery included)
 - Activator Tips 25x Small (15/.02), 25x Medium (25/.04), 25x Large (35/.04)
 - 100x Protective Barriers
 - 1x Directions for Use
 - 1x Sequence Card
 - 1x Instructional DVD

Endoactivator® Tips

- Sold in packs of 25
- A091302201500 Endoactivator® Tips Small
 - A091302202500 Endoactivator® Tips Medium
 - A091302203500 Endoactivator® Tips Large

Endoactivator® Accessories

- A0912000000000 Endoactivator® Handpiece Driver
- A0914000000000 Endoactivator® Protect Barriers
- A0915000000000 Endoactivator® Battery Housing
- A0916000000000 Endoactivator® Rocker Arm Replacement Kit

IRRIGATION AND OBTURATION / ENDODONTIC IRRIGATION NEEDLES

ProRinse®

Effective therapeutic cleansing with safety on the side

ProRinse® endodontic irrigation needles effectively remove pulpal debris and microbes from the root canal. They feature a rounded tip and side window port dispersal, which prevent solution and debris from being expressed through the apical foramen.

A082100023100	ProRinse® Irrigation Needles 23GA (100 per box)	A082100028100	ProRinse® Irrigation Needles 28GA (100 per box)
A082100023400	ProRinse® Irrigation Needles 23GA (40 per box)	A082100028400	ProRinse® Irrigation Needles 28GA (40 per box)
A082100023500	ProRinse® Disposable 23GA 3cc Syringes (100 per box)	A082100028500	ProRinse® Disposable 28GA 3cc Syringes (100 per box)
A082100024100	ProRinse® Irrigation Needles 24GA (100 per box)	A082100030100	ProRinse® Irrigation Needles 30GA (100 per box)
A082100024400	ProRinse® Irrigation Needles 24GA (40 per box)	A082100030400	ProRinse® Irrigation Needles 30GA (40 per box)
A082100024500	ProRinse® Disposable 24GA 3cc Syringes (100 per box)	A082100030500	ProRinse® Disposable 30GA 3cc Syringes (100 per box)
A082100025100	ProRinse® Irrigation Needles 25GA (100 per box)		
A082100025400	ProRinse® Irrigation Needles 25GA (40 per box)		
A082100025500	ProRinse® Disposable 25GA 3cc Syringes (100 per box)		

IRRIGATION AND OBTURATION / ENDODONTIC IRRIGATION NEEDLES

Irrigation Needle

Designed to improve cleaning and disinfection

The Irrigation Needle complements any treatment sequence. The back to back 2-sided vent design maintains a balanced irrigation solution volume for greater control throughout the canal. Its soft polypropylene allows the needle to curve and flex easily to follow the root canal anatomy. The plastic body makes the needle atraumatic for hard tissues.

BNSTNIRD2230G
Irrigation Needle 30 Gauge x40



Try me with...
TruNatomy™, ProTaper Gold®, WaveOne® Gold file solutions.



IRRIGATION AND OBTURATION / SEALER

AH Plus®

The gold standard in root canal sealing

AH Plus® root canal sealing material is a two-component paste based on epoxy-amine resin. To be used with hot or cold techniques, AH Plus® achieves a tight seal due to its self-adhesive properties and dimensional stability. It is biocompatible and exhibits moderate anti-microbial properties and therefore has the potential to significantly reduce the germ load in the canal. It is extremely radio-opaque so it is clearly visible on radiographs.

60620112 AH Plus® Paste (2x 4ml Tubes)

AH Temp®

60620123 AH Temp® Kit (4x 75ml Syringes and 20x Cannulas)

60620124 AH Temp® Cannula Refill (20 per pack)

AH 26®

60621102 AH 26® Refill (1x 8g Powder, 1x 10g Resin)

60621103 AH 26® Silver-free (1x 8g Powder, 1x 10g Resin)

60620002 AH 26® Resin Refill (1x 10g Resin)



AH Plus Jet®

The AH Plus Jet® mixing syringe is for direct intra-oral application and offers a more precise, convenient and faster procedure. The pre-filled, ready to use syringe gives you increased efficiency with no manual mixing needed and controlled, homogeneous mixing of both pastes.

AH Plus Jet® Starter Kit

60620115 1x AH Plus Jet® Mixing Syringe 15g, 20x Mixing Tips, 20x Intra Oral Tips, 1x Mixing Pad, 1x Illustrated Technique Guide, 1x Organiser Tray

AH Plus Jet® Syringe Refill

60620118 2x AH Plus Jet® Mixing Syringes, 15g

AH Plus Jet® Mixing Tips Refill

60620116 40x Mixing and Intra Oral Tips



IRRIGATION AND OBTURATION / HOT AND COLD OBTURATION



Paper Points

For safe and rapid drying of the canals

Paper Points are very absorbent and perfectly matched to the file systems below.

- In sterile packs, ready to use.
- Colour-coding adapted sizes for convenient use.



Paper Points for ProTaper Next®

Sold in boxes of 180 - packaged in sterile cell packs

A022Q00000200 Paper Points for ProTaper Next® Files X2

A022Q00000300 Paper Points for ProTaper Next® Files X3

A022Q00090000 Paper Points for ProTaper Next® Files X2 and X3
90x X2, 90x X3

A022Q00090100 Paper Points for ProTaper Next® Files X4 and X5
90x X4, 90x X5



Paper Points for ProTaper Gold®

Sold in boxes of 180 - packaged in sterile cell packs

A241W0000010 Paper Points for ProTaper Gold® F1

A241W00000203 Paper Points for ProTaper Gold® F2

A241W00000303 Paper Points for ProTaper Gold® F3

A241W00000403 Paper Points for ProTaper Gold® F4

A241W00000503 Paper Points for ProTaper Gold® F5

A241W00090103 Paper Points for ProTaper Gold® Assortment Pack F1-F5



Paper Points for TruNatomy™

Sold in boxes of 180 - packaged in sterile cell packs

BSTTNPP000SML TruNatomy™ Absorbent Paper Points Small

BSTTNPP000PRM TruNatomy™ Absorbent Paper Points Prime

BSTTNPP000MED TruNatomy™ Absorbent Paper Points Medium

BSTTNPP000AST TruNatomy™ Absorbent Paper Points Assortment

Paper Points for WaveOne® Gold

Sold in boxes of 180 - packaged in sterile cell packs

A175W00000S03 Paper Points for WaveOne® Gold Small

A175W00000P03 Paper Points for WaveOne® Gold Primary

A175W00000M03 Paper Points for WaveOne® Gold Medium

A175W00000L03 Paper Points for WaveOne® Gold Large



IRRIGATION AND OBTURATION / COLD OBTURATION

Conform Fit™ Gutta-Percha

Gutta-Percha master cones with Conform Fit™ technology

Conform Fit™ technology includes:

- The right fit you can feel - Variable tapered cones provide a snug fit that reaches the apex for the right tug back
- Improved flow to the end - Micronised gutta-percha has a better flow and transfers heat up to 4mm
- A latex free formula - The unique formula is latex free for patient safety and can be used at a lower working temperature
- The simplicity of a total solution - Precision matched shapes and sizes remove the guesswork

Formulated for enhanced fit and flow.

Conform Fit™ Gutta-Percha for ProTaper Next®

- Sold in boxes of 60
- | | |
|---------------|--|
| B00PNGPF00X2 | Conform Fit™ Gutta-Percha for ProTaperNext® Files X2 |
| B00PNGPF00X3 | Conform Fit™ Gutta-Percha for ProTaper Next® Files X3 |
| B00PNGPF00X23 | Conform Fit™ Gutta-Percha for ProTaper Next® Files X2 and X3
30x X2, 30x X3 |
| B00PNGPF00X45 | Conform Fit™ Gutta-Percha for ProTaper Next® Files X4 and X5
30x X4, 30x X5 |



Conform Fit™ Gutta-Percha for TruNatomy™

- Sold in boxes of 60
- | | |
|---------------|---|
| B00TNGPF00SML | TruNatomy™ Conform Fit™ Gutta Percha Small |
| B00TNGPF00PRM | TruNatomy™ Conform Fit™ Gutta Percha Prime |
| B00TNGPF00MED | TruNatomy™ Conform Fit™ Gutta Percha Medium |
| B00TNGPF00AST | TruNatomy™ Conform Fit™ Gutta Percha Assortment |



Conform Fit™ Gutta-Percha for WaveOne® Gold

- Sold in boxes of 60 - variable taper
- | | |
|---------------|--|
| B00WGGPF00SML | Conform Fit™ Gutta-Percha for WaveOne® Gold - Small |
| B00WGGPF00PRI | Conform Fit™ Gutta-Percha for WaveOne® Gold - Primary |
| B00WGGPF00MED | Conform Fit™ Gutta-Percha for WaveOne® Gold - Medium |
| B00WGGPF00LRG | Conform Fit™ Gutta-Percha for WaveOne® Gold - Large |
| B00WGGPF00AST | Conform Fit™ Gutta-Percha for WaveOne® Gold - Assortment |



Conform Fit™ Gutta-Percha for ProTaper Gold®

- Sold in boxes of 60 - variable taper
- | | |
|---------------|--|
| B00PGGPF00F1 | Conform Fit™ Gutta-Percha for ProTaper Gold® - F1 |
| B00PGGPF00F2 | Conform Fit™ Gutta-Percha for ProTaper Gold® - F2 |
| B00PGGPF00F3 | Conform Fit™ Gutta-Percha for ProTaper Gold® - F3 |
| B00PGGPF00F23 | Conform Fit™ Gutta-Percha for ProTaper Gold® - F2/F3 |
| B00PGGPF00F45 | Conform Fit™ Gutta-Percha for ProTaper Gold® - F4/F5 |



Gutta-Smart® Conform Fit™ Gutta-Percha Cartridges

- Sold in blisters of 10
- | | |
|---------------|--|
| BNSGSIQA0020G | Gutta-Smart® Conform Fit™ Gutta-Percha Cartridges, 20G |
| BNSGSIQA0023G | Gutta-Smart® Conform Fit™ Gutta-Percha Cartridges, 23G |
| BNSGSIQA0025G | Gutta-Smart® Conform Fit™ Gutta-Percha Cartridges, 25G |



Gutta-Percha Auxiliary Points

Sold in boxes of 120 or 60

Item Number	Point Type	Individual Packs - x60 or x120 of one type	Assortment Packs 120 per Box
A022F00000100	A	Box 120	A022F00090000 A x30, B x30, C x30, D x30
A022F00000200	B	Box 120	
A022F00000300	C	Box 120	
A022F00000400	D	Box 120	
A022L00000100	XXF	Box 120	N/A
A022L00000200	XF	Box 120	A022L00090000 XF x40, F x40, M x30, L x10
A022L00000300	F	Box 120	
A022L00000400	M	Box 120	
A022L00000500	L	Box 60	

Gutta-Percha Points Pink

Sold in boxes of 120 or 60, Length 29mm

Item Number	Point Type	Tip Size ISO	Individual Packs - x60 or x120 of one type	Assortment Packs 120 or 60 per Box
A022C00001000	10	.20	Box 120	A022C00090000 15 x20, 20 x20, 25 x20, 30 x20, 35 x20, 40 x20
A022C00001500	15	.20	Box 120	
A022C00002000	20	.20	Box 120	
A022C00002500	25	.20	Box 120	
A022C00003000	30	.20	Box 120	
A022C00003500	35	.20	Box 120	
A022C00004000	40	.20	Box 120	A022C00090100 45 x20, 50 x20, 55 x20, 60 x20, 70 x20, 80 x20
A022C00004500	45	.20	Box 120	
A022C00005000	50	.20	Box 120	
A022C00005500	55	.20	Box 120	
A022C00006000	60	.20	Box 120	
A022C00007000	70	.20	Box 120	
A022C00008000	80	.20	Box 120	A022C00090200 90 x10, 100 x10, 110 x10, 120 x10, 130 x10, 140 x10
A022C00010000	100	.20	Box 120	
A022C00011000	110	.20	Box 120	
A022C00012000	120	.20	Box 120	
A022C00013000	130	.20	Box 120	
A022C00014000	140	.20	Box 60	

Colour Coded Gutta-Percha Points

Sold in boxes of 120 or 60, Length 30mm

Item Number	Point Type	Tip Size ISO	Individual Packs - x60 or x120 of one type	Assortment Packs 120 or 60 Box
A022G00001000	10	.20	Box 120	A022G000-90000 15 x20, 20 x20, 25 x20, 30 x20, 35 x20, 40 x20
A022G00001500	15	.20	Box 120	
A022G00002000	20	.20	Box 120	
A022G00002500	25	.20	Box 120	
A022G00003000	30	.20	Box 120	
A022G00003500	35	.20	Box 120	
A022G00004000	40	.20	Box 120	A022G000-90100 45 x20, 50 x20, 55 x20, 60 x20, 70 x20, 80 x20
A022G00004500	45	.20	Box 120	
A022G00005000	50	.20	Box 120	
A022G00005500	55	.20	Box 120	
A022G00006000	60	.20	Box 120	
A022G00007000	70	.20	Box 120	
A022G00008000	80	.20	Box 120	A022G000-90200 90 x20, 100 x20, 110 x20, 120 x10, 130 x20, 140 x20
A022G00009000	90	.20	Box 60	
A022G00010000	100	.20	Box 60	
A022G00011000	110	.20	Box 60	
A022G00012000	120	.20	Box 120	
A022G00013000	130	.20	Box 120	
A022G00014000	140	.20	Box 60	

Sold in boxes of 120, Length 30mm

Item Number	Point Type	Tip Size ISO	Individual Packs - x60 or x120 of one type	Assortment Packs 120 or 60 Box
A022M00001500	15	.40	Box 120	A022M00090000 15 x20, 20 x20, 25 x20, 30 x20, 35 x20, 40 x20
A022M00002000	20	.40	Box 120	
A022M00002500	25	.40	Box 120	
A022M00003000	30	.40	Box 120	
A022M00003500	35	.40	Box 120	
A022M00004000	40	.40	Box 120	
A022M00004500	45	.40	Box 120	A022M00090100 45 x4, 60 x40, 90 x40
A022M00006000	60	.40	Box 120	
A022M00009000	90	.40	Box 60	

Sold in boxes of 120, Length 30mm

Item Number	Point Type	Tip Size ISO	Assortment Pack 120 Box
A022N00001500	15	.60	A022N00090000 15 x20, 20 x20, 25 x20, 30 x20, 35 x20, 40 x20
A022N00002000	20	.60	
A022N00002500	25	.60	
A022N00003000	30	.60	
A022N00003500	35	.60	
A022N00004000	40	.60	



IRRIGATION AND OBTURATION / HOT OBTURATION

GuttaCore®

Travel challenging canals with confidence

GuttaCore® is the first endodontic obturator with a crosslinked gutta-percha core. Crosslinking is a well-established scientific process that connects the polymer chains and transforms the gutta-percha to make it stronger, while keeping its best features:

Treatment quality

- No plastic core
- Offers a superior 3D fill
- Offers excellent radiopacity
- Easy retreatment
- Post space simplified

Simplicity

- Easy in. Easy out. Easy choice
- Matches the shape created by today's files

Security and convenience

- Safe and biocompatible
- Predictable results
- Delivers all the efficiencies and the convenience you expect

Time saving

- Heated in seconds
- Placed in seconds
- Removed in seconds

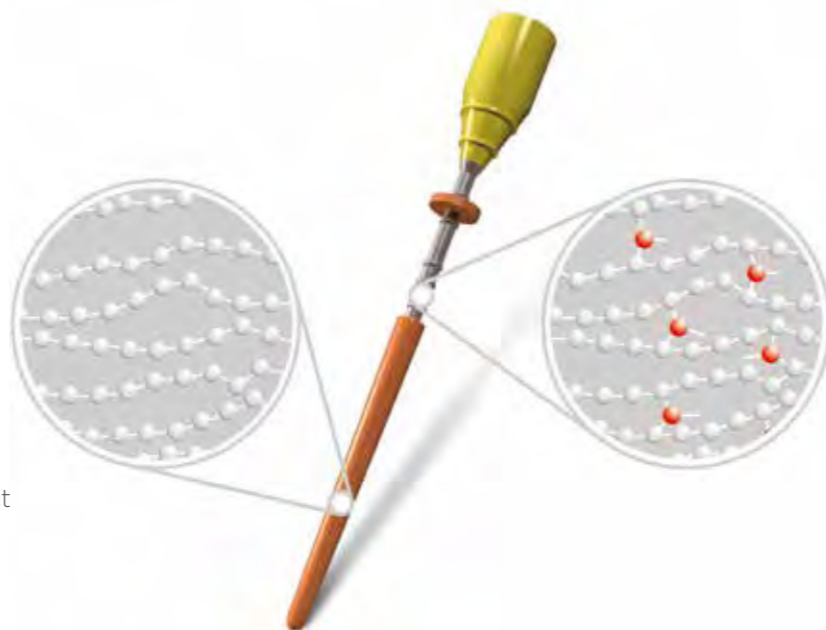

GuttaCore® Obturators

Sold in a blister of 6

A1703B0042000	GuttaCore® Obturators	Tip Size ISO: 20
A1703B0042500	GuttaCore® Obturators	Tip Size ISO: 25
A1703B0043000	GuttaCore® Obturators	Tip Size ISO: 30
A1703B0043500	GuttaCore® Obturators	Tip Size ISO: 35
A1703B0044000	GuttaCore® Obturators	Tip Size ISO: 40
A1703B0044500	GuttaCore® Obturators	Tip Size ISO: 45
A1703B0045000	GuttaCore® Obturators	Tip Size ISO: 50
A1703B0045500	GuttaCore® Obturators	Tip Size ISO: 55
A1703B0046000	GuttaCore® Obturators	Tip Size ISO: 60
A1703B0047000	GuttaCore® Obturators	Tip Size ISO: 70
A1703B0048000	GuttaCore® Obturators	Tip Size ISO: 80
A1703B0049000	GuttaCore® Obturators	Tip Size ISO: 90

Sold in a box of 30

A1703P0042000	GuttaCore® Obturators	Tip Size ISO: 20
A1703P0042500	GuttaCore® Obturators	Tip Size ISO: 25
A1703P0043000	GuttaCore® Obturators	Tip Size ISO: 30
A1703P0043500	GuttaCore® Obturators	Tip Size ISO: 35
A1703P0044000	GuttaCore® Obturators	Tip Size ISO: 40

GuttaCore® for ProTaper Next®

Sold in a blister of 6

A1803B0042500	GuttaCore® Obturators for ProTaper Next®	X2
A1803B0043000	GuttaCore® Obturators for ProTaper Next®	X3
A1803B0044000	GuttaCore® Obturators for ProTaper Next®	X4
A1803B0045000	GuttaCore® Obturators for ProTaper Next®	X5
Sold in a box of 30		
A1803P0042500	GuttaCore® Obturators for ProTaper Next®	X2
A1803P0043000	GuttaCore® Obturators for ProTaper Next®	X3
A1803P0044000	GuttaCore® Obturators for ProTaper Next®	X4

GuttaCore® for WaveOne® Gold

Blister of 6x Obturators

BNSGCWG500SML	GuttaCore® Obturators for WaveOne®	Gold Small
BNSGCWG500PRI	GuttaCore® Obturators for WaveOne®	Gold Prime
BNSGCWG500MED	GuttaCore® Obturators for WaveOne®	Gold Medium
BNSGCWG500LRG	GuttaCore® Obturators for WaveOne®	Gold Large

Box of 30x Obturators (5 Blisters)

BNSGCWGC00SML	GuttaCore® Obturators for WaveOne®	Gold Small
BNSGCWGC00PRI	GuttaCore® Obturators for WaveOne®	Gold Prime
BNSGCWGC00MED	GuttaCore® Obturators for WaveOne®	Gold Medium
BNSGCWGC00LRG	GuttaCore® Obturators for WaveOne®	Gold Large

+

WE
KNOW
ENDO.

Durable, cordless performance



All-day power*



Gutta-percha with low-temperature flow



MAILLEFER

Gutta-Smart™ + Conform Fit™ Gutta-Percha
Total Cordless Obturation Solution

The warm vertical solution that flows together

Designed to work together, Gutta-Smart™ and Conform Fit™ Gutta-Percha feature the same low-temperature flow characteristics and radiopacity for a total warm vertical obturation solution.

Visit dentsplysirona.com/gutta-smart to learn more.

**Dentsply
Sirona**

The Bluetooth® word mark and logos are registered trademarks owned by the Bluetooth SIG, Inc. and any use of such marks by Dentsply Sirona Endodontics is under license. Other trademarks and trade names are those of their respective owners.

*The battery capacities of the Flow and Pack handpieces allow for them to be used up to five procedures per day on a single charge.



IRRIGATION AND OBTURATION / HOT OBTURATION

Thermafil®

A reliable filling technique

With the support of more than 200 publications¹, Thermafil® is one of the most reliable filling techniques available on the market today. In a single insertion, Thermafil® achieves a three-dimensional filling of root canals in less than half the time of other techniques such as vertical compaction, single cone obturation and warm gutta-percha, allowing you to save time, whilst providing excellent treatment to your patients.



Thermafil®

Sold in boxes of 6

A016602502012	Thermafil® Obturators	Tip Size ISO: 20
A016602502512	Thermafil® Obturators	Tip Size ISO: 25
A016602503012	Thermafil® Obturators	Tip Size ISO: 30
A016602503512	Thermafil® Obturators	Tip Size ISO: 35
A016602504012	Thermafil® Obturators	Tip Size ISO: 40
A016602504512	Thermafil® Obturators	Tip Size ISO: 45
A016602505000	Thermafil® Obturators	Tip Size ISO: 50
A016602505500	Thermafil® Obturators	Tip Size ISO: 55
A016602506000	Thermafil® Obturators	Tip Size ISO: 60
A016602507000	Thermafil® Obturators	Tip Size ISO: 70
A016602508000	Thermafil® Obturators	Tip Size ISO: 80
A016602509000	Thermafil® Obturators	Tip Size ISO: 90
A016602510000	Thermafil® Obturators	Tip Size ISO: 100

Sold in boxes of 30

A034802502012	Thermafil® Obturators	Tip Size ISO: 20
A034802502512	Thermafil® Obturators	Tip Size ISO: 25
A034802503012	Thermafil® Obturators	Tip Size ISO: 30
A034802503500	Thermafil® Obturators	Tip Size ISO: 35
A034802504000	Thermafil® Obturators	Tip Size ISO: 40

Assortment Packs

Sold in boxes of 20

A016800090000	Thermafil® Obturators	Anterior Kit - 20x Assorted Tip Size (ISO 45-100)
A016700090000	Thermafil® Obturators	Posterior Kit - 20x Assorted Tip Size (ISO 20-40)



Thermafil® for ProTaper Gold®

Sold in boxes of 30

A1411P0000100	Thermafil® Obturators for ProTaper Gold®	F1
A1411P0000200	Thermafil® Obturators for ProTaper Gold®	F2
A1411P0000300	Thermafil® Obturators for ProTaper Gold®	F3
A1411P0000400	Thermafil® Obturators for ProTaper Gold®	F4
A1411P0000500	Thermafil® Obturators for ProTaper Gold®	F5

Sold in blisters of 6

A1411B0000100	Thermafil® Obturators for ProTaper Gold®	F1
A1411B0000200	Thermafil® Obturators for ProTaper Gold®	F2
A1411B0000300	Thermafil® Obturators for ProTaper Gold®	F3
A1411B0000400	Thermafil® Obturators for ProTaper Gold®	F4
A1411B0000500	Thermafil® Obturators for ProTaper Gold®	F5

Thermafil® for WaveOne® Gold

Sold in boxes of 30

A1750P0000S00	Thermafil® Obturators for WaveOne® Gold - Small
A1750P0000P00	Thermafil® Obturators for WaveOne® Gold - Primary
A1750P0000M00	Thermafil® Obturators for WaveOne® Gold - Medium
A1750P0000L00	Thermafil® Obturators for WaveOne® Gold - Large

Sold in blisters of 6

A1750B0000S00	Thermafil® Obturators for WaveOne® Gold - Small
A1750B0000P00	Thermafil® Obturators for WaveOne® Gold - Primary
A1750B0000M00	Thermafil® Obturators for WaveOne® Gold - Medium
A1750B0000L00	Thermafil® Obturators for WaveOne® Gold - Large



IRRIGATION AND OBTURATION / HOT OBTURATION

Thermaprep® 2

3-dimensional heat for a 3-dimensional obturation

The Thermaprep® 2 oven is specifically designed for heating WaveOne® Gold, ProTaper Gold® and Thermafil® obturators. The obturators are heated to the optimal temperature with a built-in timer indicating when the obturators are ready for placement.

The Thermaprep® 2 oven offers:

- 3-dimensional heat - Obturators are heated in seconds in single and dual heating modes. 3-dimensional heat is evenly maintained in the heating chamber until the obturator is ready to use, making it ideal for multi-canal procedures
- Indicator lights and audible alerts - The oven uses both LED indicator lights and audible alerts to indicate status changes
- Slow release obturator holders - Obturator holders are designed to allow stable vertical entry and exit of the heating chamber
- Cleaning mode - The cleaning mode raises the temperature of the oven and softens gutta-percha inside the heating chamber for removal
- The oven heats up obturators in 20 to 49 seconds, depending on the size of the obturator
- A built-in timer audibly signals when the filling material reaches the right temperature
- The obturator is kept at the right temperature for 90 seconds



The obturator holders are designed to allow for a slow and progressive entry of the obturator into the heating chamber.

A017623000200 Thermaprep® 2 Oven 230V

¹ Data on file



IRRIGATION AND OBTURATION / HOT OBTURATION

Gutta-Smart®

Part of a warm vertical solution that flows together

Optimise your obturation with the complete, low-temperature solution. Fill canals conveniently and reliably with Gutta-Smart™ cordless obturation device and Conform Fit™ gutta-percha master cones. Designed to work together, they feature the same low-temperature flow characteristics and radiopacity for a total warm vertical obturation solution.

Patient safety

You can feel confident knowing the unique formula is not made with natural rubber latex.

Gutta-percha with low-temperature flow

In both Conform Fit™ master cones and Gutta-Smart™ cartridges, the gutta-percha formula flows at a lower temperature, requiring less heat from the handpieces.

The right fit you can feel

Conform Fit™ master cones provide a snug apical fit for accurate tug-back, while the cordless Gutta-Smart™ handpieces provide precise control and excellent tactile feedback.

All-day power*

A single charge gives you the power to complete an entire day's work.

Durable, cordless performance

Well-balanced, lightweight and comfortable to use, both handpieces are cordless for freedom of movement.



Gutta-Smart™ Cordless Obturation Device Kit

B00GSIQ000KIT

1x Flow handpiece, 1x Pack handpiece, 1x base station, 1x power adapter, 4x universal plug adapters, 1x heating element, 2x cleaning caps (1 per handpiece), 1x bending tool, 3x electric heat pluggers (S, M, L), 2x Conform Fit™ Gutta-Percha cartridges (20G & 23G)

Consumables

BNSGSIQA0020G 20G
BNSGSIQA0023G 23G
BNSGSIQA0025G 25G

Gutta-Smart™ Electric Heat Pluggers

(Blister of 1)

B00GSIQ100SML Small
B00GSIQ100MED Medium
B00GSIQ100LRG Large

Accessories

B00GSIQ100000 Gutta-Smart™ Thermal Response Tip
BCPGSIQ000HES Gutta-Smart™ Heating Element
BCPGSIQ000FLO Gutta-Smart™ Flow Handpiece
BCPGSIQ000PAK Gutta-Smart™ Pack Handpiece
BCPGSIQ000BET Gutta-Smart™ Bending Tool Cap
BCPGSIQ000CAP Gutta-Smart™ Cleaning Cap
BCPGSIQ000RPC Gutta-Smart™ Remote Power Cord



IRRIGATION AND OBTURATION / INSTRUMENTS

Obturation Accessories

For hot and cold obturation

Pluggers

A289S00100200 Dr Machtou Plugger 1-2
A289S00300400 Dr Machtou Plugger 3-4
A289S000000000 Dr Machtou Plugger 0 Niti

Spreaders

Box of 4
A019802500000 Spreader A Ø ISO 025
A019803000000 Spreader A Ø ISO 030
A019804000000 Spreader A Ø ISO 040
A019805000000 Spreader A Ø ISO 050
A0198060000000 Spreader A Ø ISO 060
A0198000900000 Spreader A Ø ISO 030-060 (assorted)

Box of 3

A035000000100 Micro-Opener Size 10.04 Taper, Dark Purple
A035000000300 Micro-Opener Size 10.06 Taper, Light Purple
A035000000200 Micro-Opener Size 15.04 Taper, White

Box of 3

A035300000100 Micro Debrider 020.02, Yellow
A035300000200 Micro Debrider 030.02, Blue

Lentulo® Spiral Fillers

17mm. Spiral filler. Used to apply sealant into root canal. Recommended rotation speed: 300-600 min⁻¹.



Sold in packs of 4
A002221700100 17mm Size 1
A002221700200 17mm Size 2
A002221700300 17mm Size 3
A002221700400 17mm Size 4
A0022217900000 17mm Assorted Sizes 1-4
A002222100112 21mm Size 1
A002222100212 21mm Size 2
A002222100312 21mm Size 3
A002222100412 21mm Size 4
A002222190012 21mm Assorted Sizes 1-4
A002222500112 25mm Size 1
A002222500212 25mm Size 2
A002222500312 25mm Size 3
A002222500412 25mm Size 4
A002222590012 25mm Assorted Sizes 1-4

The item numbers shown above ending '12' are for non-CE marked packs only. To order a CE marked pack, replace the last two digits '12' with '00'.

Finger Spreaders - Cone Flat

Stainless steel finger spreaders. Sold in boxes of 4
A018202100100 21mm A
A018202100200 21mm B
A018202100300 21mm C
A018202100400 21mm D
A0182021900000 21mm Assorted A-D

A018202500100 25mm A
A018202500200 25mm B
A018202500300 25mm C
A018202500400 25mm D
A0182025900000 25mm Assorted A-D

Finger Spreaders - Pointed

Stainless steel finger spreaders. Sold in boxes of 4
A020602101000 21mm 10
A020602102000 21mm 20
A020602103000 21mm 30
A020602104000 21mm 40
A0206021900000 21mm Assorted 10-40

A020602501000 25mm 10
A020602502000 25mm 20
A020602503000 25mm 30
A020602504000 25mm 40
A0206025900000 25mm Assorted 10-40

Gauge for GP Points



A018600000000 Gauge for GP Points

Gutta Condenser



Sold in boxes of 4
A024202102500 21mm 25
A024202103000 21mm 30
A024202103500 21mm 35
A024202104000 21mm 40
A0242021900000 21mm Assorted 25-40
A024202502500 25mm 25
A024202503000 25mm 30
A024202503500 25mm 35
A024202504000 25mm 40
A0242025900000 25mm Assorted 25-40

*The battery capacities of the Flow and Pack handpieces allow for them to be used up to five procedures per day on a single charge.

¹ As compared to Dentsply Sirona Calamus® Dual; data available.



PINS AND POSTS

UNICLIP

Drills and posts with easy item identification

UNICLIP are plastic burn-out root canal posts providing several user benefits:

- Easy post selection by placing the transparent drawing over the radiograph
- Clip head for perfect positioning
- Colour-coded for easy item identification

UNICLIP Special Penetration Drills **SSi**

Box of 6

C02122000800	Special Penetration Drill 008
C021220010800	Special Penetration Drill 108
C021220011000	Special Penetration Drill 110
C021220020800	Special Penetration Drill 208
C021220021000	Special Penetration Drill 210
C021220030800	Special Penetration Drill 308
C021220031000	Special Penetration Drill 310

UNICLIP Special Calibrating Drills **SSi**

Box of 6

C02132000800	Special Calibrating Drill 008
C021320010800	Special Calibrating Drill 108
C021320011000	Special Calibrating Drill 110
C021320020800	Special Calibrating Drill 208
C021320021000	Special Calibrating Drill 210
C021320030800	Special Calibrating Drill 308
C021320031000	Special Calibrating Drill 310

UNICLIP Burn Out Plastic Posts **P**

Pack of 100

C215U00010800	Uniclip Burn Out Plastic Posts 108
C215U00011000	Uniclip Burn Out Plastic Posts 110
C215U00020800	Uniclip Burn Out Plastic Posts 208
C215U00021000	Uniclip Burn Out Plastic Posts 210
C215U00030800	Uniclip Burn Out Plastic Posts 308
C215U00031000	Uniclip Burn Out Plastic Posts 310

UNICLIP Sets **P**

C226T00000800	Unimetric Set Titanium 0.8mm
C226T00001000	Unimetric Set Titanium 1mm
C226U00000800	Uniclip Set 0.8mm
C226U00001000	Uniclip Set 1mm



PINS AND POSTS

MOOSER

Plastic burn out posts

MOOSER Calcinable Plastic Posts **P**

Box of 100

C024100000800	Tip Size ISO 08
C024100001000	Tip Size ISO 10
C0243000000000	Assortment



PINS AND POSTS

Radix Anker®

Radix Anker® Standard Posts **SSi**

Box of 12

C019300000100	Post Standard 1 - ISO Ø1.15
C019300000200	Post Standard 2 - ISO Ø1.35
C019300000300	Post Standard 3 - ISO Ø1.6

Gauge Radix Anker®

Box of 12

C019100000100	Gauge Radix Anker® 1
C019100000200	Gauge Radix Anker® 2
C019100000300	Gauge Radix Anker® 3
C019100003B00	Gauge Radix Anker® 3b

Gauge Radix Anker® Long

Box of 12

C026400000100	Gauge Radix Anker® Long 1
C026400000200	Gauge Radix Anker® Long 2
C026400000300	Gauge Radix Anker® Long 3

Radix Anker® Standard Titanium Posts **Ti**

Box of 12

C193T00000100	Post Standard Titanium 1 - ISO Ø1.15
C193T00000200	Post Standard Titanium 2 - ISO Ø1.35
C193T00000300	Post Standard Titanium 3 - ISO Ø1.6
C193T00003B00	Post Standard Titanium 3B - ISO Ø1.6

Radix Anker® Long Posts **Ti**

Box of 12

C026100000100	Post Long 1 - ISO Ø1.15
C026100000200	Post Long 2 - ISO Ø1.35
C026100000300	Post Long 3 - ISO Ø1.6

Radix Anker® Long Set **Ti**

Box of 12

C0310000000000

Radix Anker® Long Set

Radix Anker® Titanium Refill Set **Ti**

Box of 12

C195DT00000000

Refill Set Titanium 123

Radix Anker® Titanium Integral Sets **Ti**

Box of 12

C195CT0000100	Integral Set, Titanium 1
C195CT0000200	Integral Set, Titanium 2
C195CT0000300	Integral Set, Titanium 3

Radix Anker® Normal Refill Set **SSi**

Box of 12

C195D00000000

Refill Set Normal

Radix Anker® Normal Integral Sets **SSi**

Box of 12

C195C00000100	Integral Set, Normal 1
C195C00000200	Integral Set, Normal 2
C195C00000300	Integral Set, Normal 3

Radix Anker® Precision Drills **Ti**

Box of 6

C022020000100	Penetration Drill 1
C022020000200	Penetration Drill 2
C022020000300	Penetration Drill 3
C022020003B00	Penetration Drill 3b





PINS AND POSTS

EasyPost™

Used for endodontic retreatment and special cases

EasyPost™ is a composite combination of an epoxy resin matrix reinforced with zircon enriched silicon fibres. With a longitudinal modulus of elasticity and shear strength close to that of dentine, its mechanical properties are ideal for a homogeneous reconstruction which minimises the risks of root fracture.

EasyPost™ Posts 

Fiberglass. Blister of 10

C060000000100	EasyPost No 1
C060000000200	EasyPost No 2
C060000000300	EasyPost No 3
C060000000400	EasyPost No 4
C060000000500	EasyPost No 5
C060000000600	EasyPost No 6

EasyPost™ Kits 

(Includes 24x EasyPost™, 1x Largo Peeso Reamer, 2x EasyPost™ Precision Drill) Fiberglass.

C060200800100	EasyPost Set 0.8
C060201000100	EasyPost Set 1.0
C060201300100	EasyPost Set 1.3

EasyPost™ Precision Drills 

Box of 3

C0601000000100	Precision Drill 1
C0601000000200	Precision Drill 2
C0601000000300	Precision Drill 3
C0601000000400	Precision Drill 4



PINS AND POSTS

X-Post®

Reinforce your reconstruction with a stable build-up

X-Post® is an endodontic fiber post for direct, adhesive core build-up to support the coronal restoration in case of insufficient residual tooth substance. It has dentin like elasticity and its parallel oriented glass fibres prevent fissures or fractures.



X-Post® Endodontic Fiber Post Refill

(5x X-Post® Fiber Posts)

60667332	Size 1 (yellow)	60667334	Size 3 (blue)
60667333	Size 2 (red)	60667335	Size 4 (green)



SURGICAL

ProRoot® MTA

Root canal repair material

A superior root repair material with water-based chemistry allowing normal setting in the presence of moisture. ProRoot® MTA has resistance to marginal leakage and reduction of bacterial migration, giving a normal healing response without inflammation. It is easy to use and comes in a tooth coloured formula.

ProRoot® MTA Tubes

Pack of 50

A040300000100	ProRoot® MTA Tubes – Endo, 8mm	A040500000400	ProRoot® MTA 10x0.5g White
A040300000200	ProRoot® MTA Tubes – Surgical, 4mm	A040500000300	ProRoot® MTA 4x0.5g White

YOU ARE ENDO,
WE KNOW ENDO.

Our Endo **expertise** comes from our historical **knowledge** and continuous investment in **R&D**.

Our quest is to provide you with the **safest**, most **reliable**, **high quality**, **innovative** solutions supported by state-of-the-art **education**.

Learn more on weknowendo.com

 **Dentsply
Sirona**
Endodontics

Solutions for Restorative Success

Mastering every step in every restorative procedure is essential for dental professionals to be able to provide the best possible dental care, for the benefit of both their patients and practices. Backed by innovation and dental industry expertise, Dentsply Sirona has a restorative portfolio that offers cutting-edge materials and a long history of clinically-proven results.

Class II Solution™ for direct restorations:

The Class II restoration is more important to a practice than you may think. By optimising a Class II procedure it can be an instant way to improve profitability. The Class II Solution™ is a proven approach to achieving a reliable outcome, addressing key challenges with innovative product solutions at each step of the procedure. The Class II Solution™ provides you with tools to achieve procedure success and patient satisfaction.

1. Matrix Placement



Palodent® V3
Palodent® 360

2. Bonding



Prime&Bond universal™

3. Bulk-Fill



SDR® Plus

4. Capping, Finishing & Polishing



Neo Spectra™ ST
Enhance®

Single-Unit Crown Total Practice Solution for indirect restorations:

Dentists need a process that creates an accurate fitting provisional crown to protect the prep and surrounding tissue between visits and a final impression, whilst also maintaining perfect margins that allows the lab to build the most accurate permanent crown. The Single-Unit Crown Total Practice Solution delivers at every step providing dual benefits: Enhancing procedure reliability and creating ideal conditions for restoration longevity. Each high-performance product builds upon the success of the product in the previous step, to deliver a better overall procedure.

1. Impression /Scan

Aquasil® Ultra+



2. Temporisation

Integrity® Multi-Cure



3. Temporisation

Integrity® TempGrip®



4. Restoration Cementation

Calibra® Universal

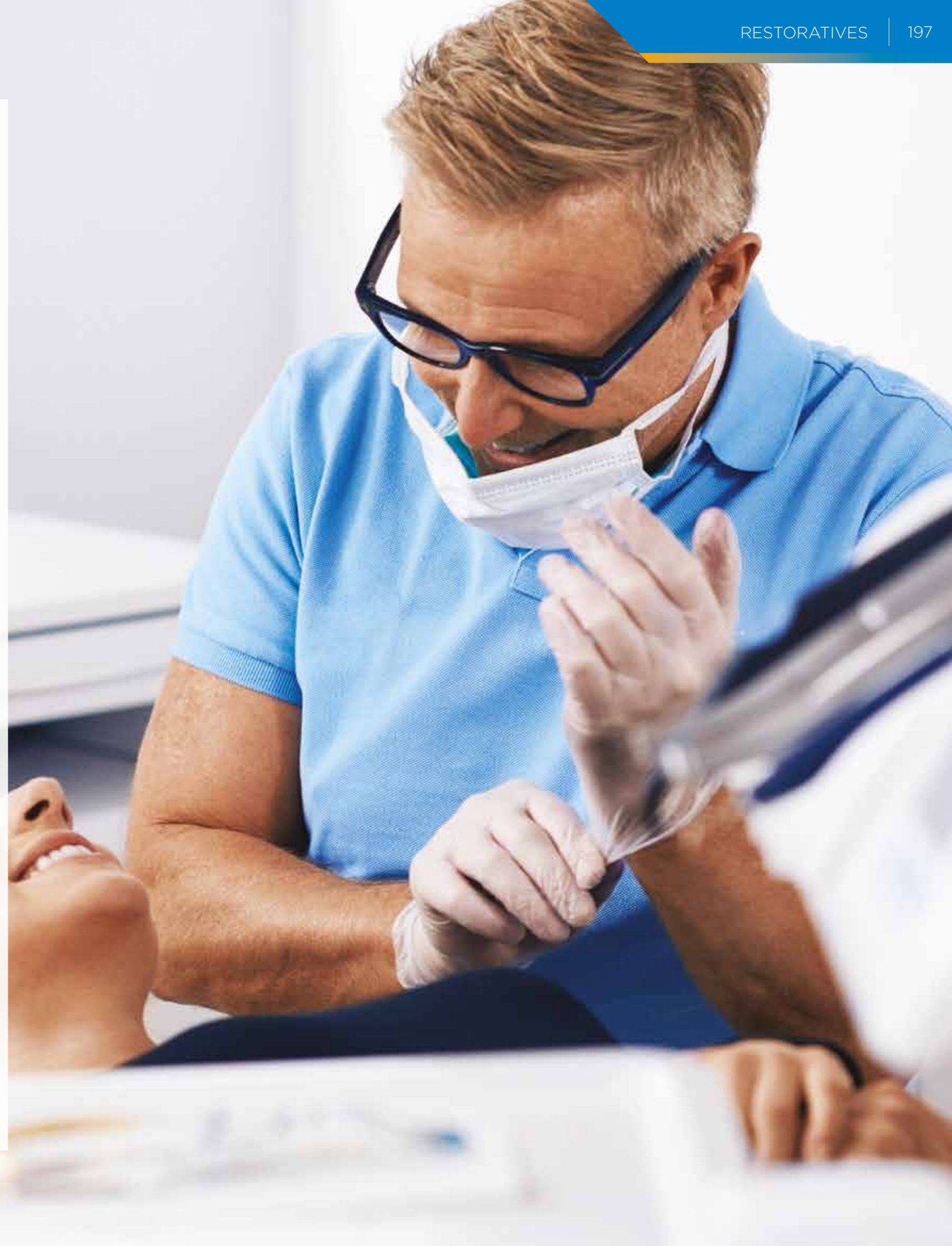

Contents

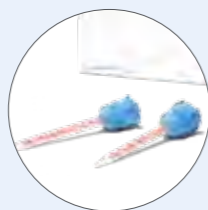

Indirect Restoration

Core Build Up	
Core-X® Flow	199
Core&Post Solution	200

Impression Materials

Aquasil® Ultra+	202
Accessories	203
Aquasil® Putty	204

Bite Registration

Aquasil® Bite	204
Regisil®	205

Tray Adhesives

Fix Adhesive & Solvent	206
------------------------	-----

Alginate

Blueprint® 20+	206
----------------	-----

Provisional Restoration (Material and Cements)

Integrity® Multi-Cure	208
Integrity® TempGrip®	209
Kalzinol	210
Visco-gel	210

Permanent Cements

Calibra® Ceram	211
Calibra® Veneer	212
Calibra® Universal	212
Calibra® Bio	213
AquaCem®	214
DeTrey® Zinc	214
Poly-F® Plus	215

Direct Restoration

Matrix System	
Palodent® V3	216
Palodent® 360	218
AutoMatrix®	218

Adhesives

Prime&Bond universal™	219
Prime&Bond® one Etch&Rinse	220
Self Cure Activator	221
DeTrey® Conditioner 36	221
Accessories	222

Curing Lights

SmartLite® Pro	223
----------------	-----

Filling Materials

SDR® Plus	224
Neo Spectra™ ST	225
Neo Spectra™ ST Effects	226
Neo Spectra™ ST Flow	226
Spectrum®	227
Esthet.X® HD	228
Surefil® one	230
QuixFil®	231
Dyract® XP	231
ChemFil® Rock, ChemFil® Superior	232

Finishing and Polishing

Enhance®	233
Enhance® PoGo®	234
Prisma® Gloss	234

Other

Dycal®	235
IRM®	235
Disperalloy®, Megalloy® EZ, ProMix™ 2	236



CORE BUILD-UP / DUAL-CURE MATERIAL AND CEMENT

Core-X® Flow

One product for two indications

Core-X Flow® is a dual-cure core build-up material and cement for endodontic posts. It consists of two components, base and catalyst, which when mixed form a dual-cured, highly filled, composite resin core build-up and post-cementation material.

Core-X® Flow uses a biocompatible urethane resin and is supplied in a tooth-coloured shade which is ideal in situations where aesthetics and show-through of the core are of primary concern.

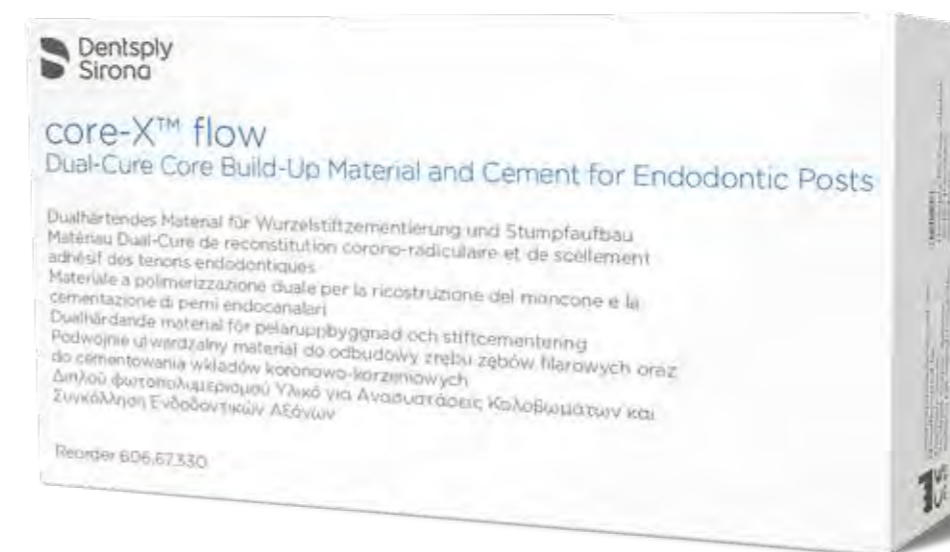

Core-X® Flow Syringe

60667330 Core-X® Flow Syringe Refill
(4x 4.75g Core-X® Flow Syringes
20x Mixing/Intraoral Tips)



Mixing Tip/Intraoral Tip Refill

60620116 40x Mixing/Intraoral Tips for Core-X®
Flow, AH Plus Jet®, SmartCem2®

Try me with...

X-Post® and Prime&Bond universal™

These system components show excellent performance and compatibility when used together, contributing to a fast and easy core build-up procedure.





CORE & POST SOLUTIONS

Core&Post Solution

Adhesive core build-up kit





The Core&Post Solution provides a complete dental treatment system for the placement of core build-ups and endodontic posts. The organiser tray has been especially designed by dentists for dentists to align the treatments steps into a simplified, guided pathway. All system components show excellent performance and compatibility and contribute to a fast and easy procedure in 5 steps or less:

1. Gutta-percha removal
2. Post preparation
3. Conditioning of root canal (optional)
4. Bonding of post and canal
5. Post cementation and core build-up

Indications

Adhesive post cementation and core build-up

Features and Benefits

-  Feature: Complete treatment system.
Benefit: All materials needed for the treatment procedure are provided in a single kit.
-  Feature: Core build-up and post cementation in one product.
Benefit: Time-saving and cost effective.
-  Feature: Clinical validation of all components.
Benefit: Long-term clinical data of components available.
-  Feature: Unique organiser tray.
Benefit: Arrangement of products according to clinical treatment sequence. High quality packaging. Fits into a single drawer.



Core&Post Solution Kit

60667500

Core&Post Solution Kit with Prime&Bond universal™

- 2x Maillefer Largo Peeso Reamer No. 1, No.2
- 4x Maillefer Precision Drill No. 1, No.2, No.3, No.4
- 5x X-Post® No. 1
- 5x X-Post® No. 2
- 3x X-Post® No. 3
- 2x X-Post® No. 4
- 30x Paper Points
- 1x Prime&Bond universal™
- 1x Self Cure Activator
- 1x CliXdish™
- 50x Root Canal Applicator Tips
- 2x Core-X® Flow Syringe
- 10x Mixing/Intraoral Tips for Core-X® Flow
- 1x Mixing Pad

Root Canal Applicator Tip Refill

60667197

- 50x Root Canal Applicator Tips

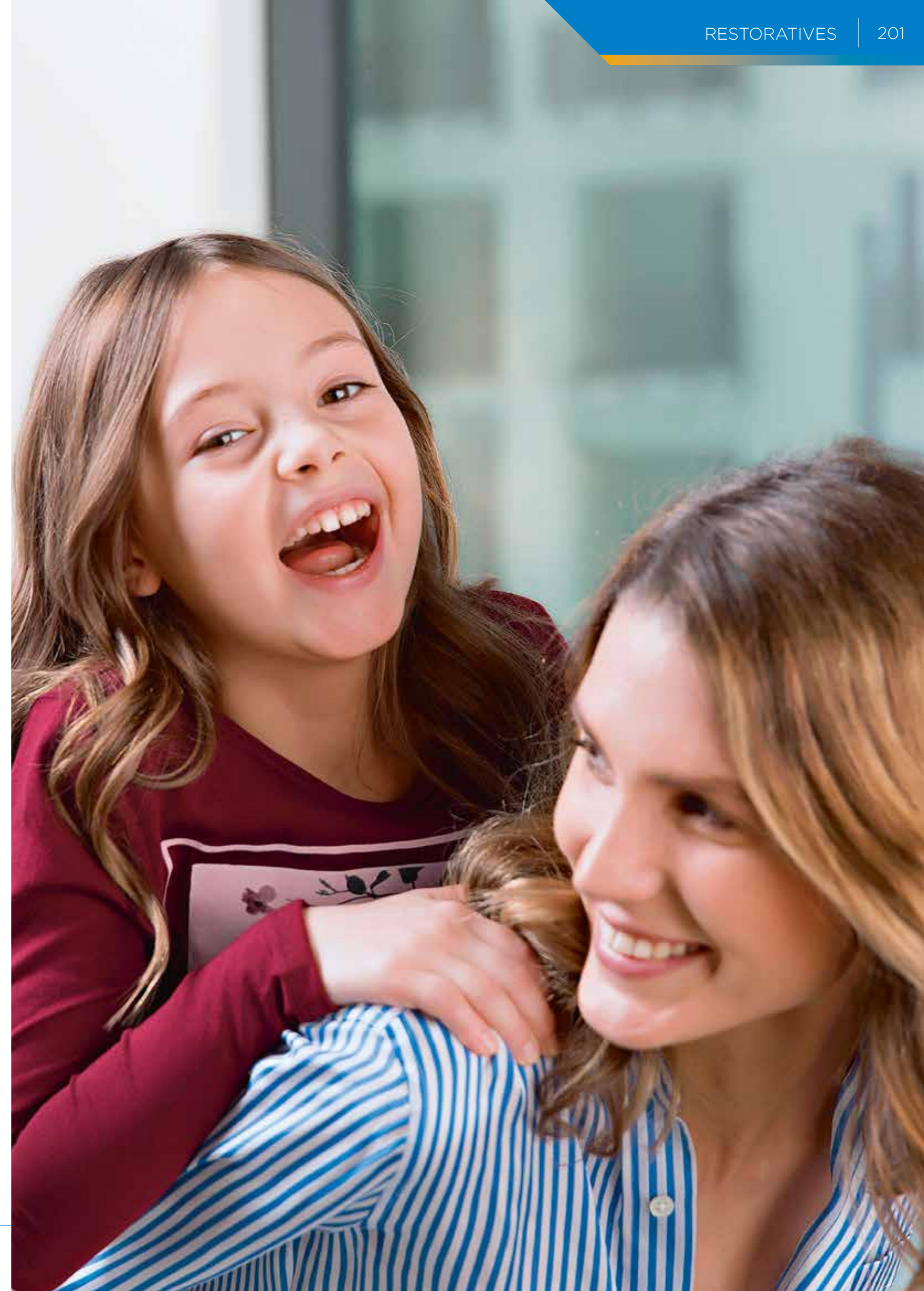



IMPRESSION MATERIALS / SILICONE

Aquasil® Ultra+

No compromise

Aquasil® Ultra+ Smart Wetting® Impression Material is a final VPS impression material indicated for use in all impression techniques. With market leading intraoral hydrophilicity and intraoral tear strength, Aquasil® Ultra+ material is optimised to perform when clinicians need it most in the challenging oral environment, enabling high detail reproduction and minimising risks of voids and tears. Aquasil® Ultra+ material is available in multiple viscosities, work/set times, and delivery options, and provides clinicians with a full range of performance and choices to satisfy a wide range of impression situations.



Tray Materials

(4x 50ml Aquasil® Ultra+ Tray Material in Cartridge, 12x Mixing Tips, and 1x Instructions for Use)

- 678673 Medium, Regular Set
- 678675 Heavy, Regular Set
- 678674 Medium, Fast Set
- 678676 Heavy, Fast Set

Wash Materials

(2x 50ml Aquasil® Ultra+ Wash Material in Cartridge, 12x Mixing Tips, and 12x Intraoral Tips)

- 678706 LV, Regular Set (teal)
- 678713 LV, Fast Set (teal)
- 678707 XLV, Regular Set (orange)
- 678714 XLV, Fast Set (orange)

NEW:
Smaller packaging sizes. Now 100ml per pack, instead of 200ml as per Aquasil® Ultra.



Features and Benefits

- Feature:** Highest intraoral and 24hrs tear strength.
Benefit: Higher accuracy due to reduced risk of tears. Multiple pours possible.
- Feature:** High intraoral and 24hrs hydrophilicity.
Benefit: Accurate impressions in the presence of moisture which helps ensure model accuracy/margin fit when poured at the lab.
- Feature:** Precision delivery and speed.
Benefit: Digit power delivery option offers precision placement (up to 63% closer), ergonomics via pen grip design and light weight, as well as convenience with single-use cartridges and easy-load design.

DECA 380

(2x 380ml Aquasil® Ultra+ Tray Material in DECA Delivery, 20x Dynamic Mixing Tips, and 1x Bayonet Ring)

- 678682 Medium, Regular Set
- 678686 Heavy, Regular Set
- 678684 Heavy, Fast Set
- 678697 Medium, Fast Set

Hand Mix Putty

(1x 250ml Aquasil® Putty Catalyst, 1x 250ml Aquasil® Putty Base, and 2x Spoon)

- 678708 Soft Putty, Fast Set (blue)
- 678709 Hard Putty, Regular Set (green)

Machine Mix Putty

(2x 380ml Aquasil® Ultra+ Putty in DECA Delivery, 10x Dynamic Mixing Tips, 1x Bayonet Ring)

- 678622 Soft Putty, Regular Set



NEW:
Smaller packaging sizes. Now 500ml per pack, instead of 900ml as per Aquasil® Ultra.

Introductory Kits

- 678711 Aquasil® Ultra+ Soft Putty, Fast Set and XLV, Regular Set Kit (1x 250ml Putty Catalyst, 1x 250ml Putty Base, and 1x 50ml XLV, Regular Set Wash Material in Cartridge)
- 678712 Aquasil® Ultra+ Soft Putty, Fast Set and LV, Regular Set Kit (1x 250ml Putty Catalyst, 1x 250ml Putty Base, and 1x 50ml LV, Regular Set Wash Material in Cartridge)

Digits

- 678645 XLV digit, Fast Set (Small 1.6ml)
- 678640 XLV digit, Regular Set (Small 1.6ml)
- 678641 XLV digit, Regular Set (Large 2.4ml)
- 678642 LV digit, Fast Set (Small 1.6ml)
- 678640 LV digit, Regular Set (Small 1.6ml)
- 678644 LV digit, Regular Set (Large 2.4ml)
- 678007 digit Standard Intraoral Mixing Tip Refill (25 per pack)
- 678020 digit Targeted Delivery System Dispenser (2 per pack)

Accessories

- 678212 Mixing Tips for Delivery in 50ml Cartridges (48 per pack)
- 626281 Aquasil® Ultra+ Intraoral Tips for Delivery in 50ml Cartridges (100 per pack)

DECA Accessories

- (40x Mixing Tips and 1x Bayonet Ring)
- 60578400 For Aquasil® Ultra+ Medium/Heavy (blue)
- 60578340 For Aquasil® Soft Putty DECA (yellow)

- (2x Bayonet Ring)
- 60578401 For Aquasil® Ultra+ Medium/Heavy (blue)
- 60578342 For Aquasil® Putty DECA (yellow)



NEW:
Give the new Aquasil® Ultra+ material a try with the Introductory Kits.



IMPRESSION MATERIALS / ACCESSORIES

Accessories



Duomix II

2761000000 Duomix II 230V
For mixing Aquasil® materials in DECA cartridges, the Duomix II offers:

- Fast extrusion speed on the market with an average of 46mm/sec
- Turbo button for double speed with Aquasil® Ultra Monophase and Heavy
- Steady extrusion rate, even for highly viscous materials
- Optimised cartridge bed for even more convenient handling
- Offered in partnership with Renfert GmbH

Caulk Tray Adhesive

Caulk Tray Adhesive is a polysiloxane-based tray adhesive which increases the adhesion between A-silicone impression materials and the impression tray surface.

- 626155 Caulk Tray Adhesive 1x 14ml Bottle



AutoMix Dispensing Gun

- 60578399 AutoMix Dispensing Gun



IMPRESSION MATERIALS / SILICONE

Aquasil® Putty

Very high viscosity precision impression materials

Aquasil® Soft Putty/Regular Set is a very high viscosity impression material with optimum flexibility for easy removal from undercuts. It is for use as a tray material for the double mix technique or as primary impression material for two-step putty/wash technique.

Aquasil® Hard Putty/Fast Set is a fast setting, very high viscosity type impression material with ideal mechanical properties as tray material for the two-step putty/wash technique.

Aquasil® Soft Putty/Regular Set - Standard Pack

60578320
(1x 450ml Base, 1x 450ml Catalyst and 2x Spoons)

Aquasil® Soft Putty/Regular Set - Eco Pack

60578321
(4x 450ml Base, 4x 450ml Catalyst and 2x Spoons)

Aquasil® Hard Putty/Fast Set - Standard Pack

60578332
(1x 450ml Base, 1x 450ml Catalyst and 2x Spoons)

Aquasil® Hard Putty/Fast Set - Eco Pack

60578333
(4x 450ml Base, 4x 450ml Catalyst and 2x Spoons)



IMPRESSION MATERIALS / BITE REGISTRATION

Aquasil® Bite

Consistently accurate records

Aquasil® Bite is designed for accurate interocclusal and jaw relation records. Aquasil® Bite accurately records dental morphology, enabling the dentist and lab technician to easily articulate models without interferences from convex tooth surfaces.

Aquasil® Bite offers minimum resistance to closure during 30 seconds working time and rapid rigidity at 1 minute mouth removal time, minimising deviation of the mandible producing consistently accurate jaw relation records.

The accurate detail reproduction, minimal distortion and quick set also allows use of Aquasil® Bite as a preparation quadrant matrix material in the direct fabrication technique of provisional restorations.

Aquasil® Bite Cartridge Refill

- 60578334
- 2x 50ml Aquasil® Bite Cartridge
 - 12x Teal Mixing Tips
 - 1x Instructions for Use

Aquasil® Bite Accessories

- 60578335 Aquasil® Bite Conturation Tips (48 per pack)
678212 Aquasil® Bite Mixing Tip (48 per pack)



IMPRESSION MATERIALS / VINYL POLYSILOXANE BITE REGISTRATION

Regisil®

Reliable interocclusal records

Regisil® is designed for accurate interocclusal records of bite registration. Regisil® offers minimum resistance to the patient's jaw closure. This minimises deviation of the mandible and aids in producing consistently accurate centric relation records.

This bite registration material accurately records occlusal details, enabling the dentist and lab technician to easily seat models with a slight amount of elasticity. This also aids in accurately seating models and dies by minimising interferences from convex tooth surfaces.

Regisil® PB™ cartridges are designed for use in conjunction with the AutoMix 50ml Gun (see page 249).

Regisil® Rigid offers virtually zero resistance to closure due to its light, fluffy, mousse-like consistency. Very-rigid final set ensures accurate model articulation and reduces elastic rebound distortion. No unpleasant odors or taste. Work time: 30 seconds, set time: 30 seconds. It comes in a 50ml split-cartridge delivery system for easier dispensing.

Regisil® 2x™ comes in a 50ml split-cartridge delivery system for easier dispensing.

Regisil® PB™ Cartridge Refill

- 619510
- 4x 50ml Regisil® PB™ Cartridges
 - 12x Mixing Tips

Regisil® Rigid 4-Pack Refill

- 619425
- 4x 50ml Cartridges
 - 12x Micro Mixing Tips



Regisil® 2x™ 4-Pack Refill

- 619500
- 4x 50ml Cartridges
 - 12x Mixing Tips





IMPRESSION MATERIALS / TRAY ADHESIVES

Fix Adhesive & Solvent

Three decades worth of success



Fix Adhesive
 Tray adhesive for alginates.
 Available in liquid or aerosol
 61601004 Fix Adhesive Liquid (1x 30ml bottle)
 61601001 Fix Adhesive Aerosol (1x 200ml can)

Fix Solvent
 For cleaning metal trays after use.
 61601101 Fix Solvent Aerosol (1x 200ml can)

Try me with...

Blueprint® 20+

Increase the adhesion between alginate impression materials and the impression tray surface with Fix Adhesive



IMPRESSION MATERIALS / ALGINATE

Blueprint® 20+

A state-of-the-art alginate

Blueprint® 20+ is a dust-free alginate impression material. The powder has been specially formulated to eliminate dust during mixing whilst being easy to mix and offering a very long dimensional stability.

Blueprint® 20+ mixes easily to a homogeneous mass, showing a smooth compact surface and with a total working time of 1 min 10 seconds (at 23°C) and a setting time of 2 mins 10 seconds (at 23°C). Blueprint 20+ offers a fast and time-saving way of achieving an excellent alginate impression.



60501110 Blueprint® 20+ Eco Pack
 (12x 500g, storage tub,
 measures)

60501999 Blueprint 20+ Measures
 (1 set of measures)

Throw away your Tofflemire.



NEW! Palodent® 360 Circumferential Matrix System

Place. Twist. Done. A twist of your fingers is all it takes to achieve tight contacts with anatomically natural contours. No more struggling with an awkward retainer or applicator. No more obstructions to your view or working space. For better restorations, faster and easier than you ever thought possible, Palodent® 360 Matrix System.

Success comes full circle.



Proper interproximal contours achieved with a Palodent® 360 matrix system

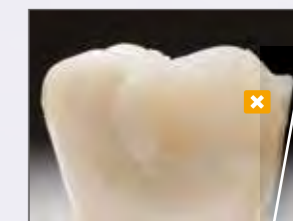

Poor interproximal contours achieved with a Tofflemire matrix system

Tofflemire is not a registered trademark of Dentsply Sirona.
 ©2019 Dentsply Sirona. All rights reserved. ML590016A (8-19-19)

PART OF DENTSPLY SIRONA'S
CLASS II TOTAL PRACTICE SOLUTION™





PROVISIONAL RESTORATION / TEMPORARY CROWN & BRIDGE MATERIAL

Integrity® Multi-Cure

Create a better provisional

Integrity® Multi-Cure Temporary Crown and Bridge Material is an automixed two-component material based on multi-functional methacrylic esthers, intended for both short and long-term provisionals.

It contains both autocure initiators and photoinitiators providing reliable self-curing of the material with the operator's option of utilizing a light curing unit to finalize the cure, reducing procedure time by up to 30%. Provisionals breaking and needing repairs do not need to be a part of the cost of doing business. Integrity® Multi-Cure Material helps remove the challenges of shrinkage and repairs as it:

- Provides strength sooner via light cure to minimize risk of trimming and adjusting prematurely
- Bonds to itself to easily add or modify material
- Has minimal shrinkage for predictable restoration success.



Cartridges

- 1x 76g, 15x Mixing Tips
- 60578361 Integrity® Multi-Cure Cartridge A1
 - 60578362 Integrity® Multi-Cure Cartridge A2
 - 60578363 Integrity® Multi-Cure Cartridge A3
 - 60578365 Integrity® Multi-Cure Cartridge A3.5

Accessories

- 60578349 Integrity® Multi-Cure Mixing Tips 50 per pack
- 666260 Integrity® Dispenser for 10:1 Cartridges 1 per pack



Try me with...

Integrity® TempGrip®

Two partners, one solution. Integrity® Multi-Cure and Integrity® TempGrip® cement are the complete solution for your temporary crowns and bridges.



PROVISIONAL RESTORATION / TEMPORARY CEMENT

Integrity® TempGrip®

Convenient, hygienic and easy handling

Integrity® TempGrip® temporary crown and bridge cement is a zinc oxide non-eugenol temporary cement used to lute indirect provisional restorations or limited term cementation of final restorations.

The physical properties have been optimised to allow secure retention of restorations, and to allow easy restoration removal and cleanup from the restoration and preparation.

Since retention of the restoration is desired for only a limited time frame, a dentin and enamel adhesive is not recommended for use with Integrity® TempGrip® cement.

Integrity® TempGrip® cement is an automatically mixed two component material in 1:1 9g dual barreled syringe based on zinc oxide and organic acids. Due to its non-eugenol formulation, it does not influence the setting of resin-based filling and luting materials.

Benefits at a glance:

- Smooth seating with a creamy feel and non-drip flow (flow of 27mm)
- Easy removal means cement stays in the crown, not on the tooth
- Short set time saves time for you and your patient
- Automix syringes with balanced base/catalyst viscosity assures the right mix
- Low film thickness with high compressive and flexural strength



Integrity® TempGrip® Syringe Refill

- 666450
- 2x 9g Integrity® TempGrip® Syringe
 - 20x Mixing Tips, Brown
 - 1x Instruction for Use
 - 1x Illustrated Technique Guide

Integrity® TempGrip® Mixing Tip Refill

- 666460
- 50x Mixing Tips, Brown



Try me with...

Integrity® Multi-Cure

Create fast and strong temporaries with high aesthetics by using both components of this ideal system: Integrity® Multi-Cure and Integrity® TempGrip® cement.





PROVISIONAL RESTORATION / TEMPORARY CEMENT

Kalzinol

Fast setting zinc-oxide eugenol cement

Kalzinol is a polymer reinforced, fast setting zinc-oxide eugenol cement in a dentin shade. Kalzinol is indicated as a base under filling materials, soothing temporary filling, temporary seal for medicament dressings as well as indirect pulp capping.



- 61116001 1x 15ml Kalzinol Liquid Refill
- 61116100 1x 40g Kalzinol Powder Refill



PROVISIONAL RESTORATION / TEMPORARY LINER

Visco-gel

Temporary denture reliner

Visco-gel is a tissue conditioner and temporary soft denture liner.



- Visco-gel Kit**
61605002
- 1x 120g Powder
 - 1x 90ml Liquid
 - 1x 15ml Lubricant
 - Accessories



PERMANENT CEMENTS / ADHESIVE RESIN CEMENT

Calibra® Ceram

Excellent strength and easy clean-up

Calibra® Ceram adhesive resin cement is a visible light cured, dual-cured or self-cured high strength resin cement which contains fluoride. Calibra® Ceram cement is designed to be used following the application of a compatible adhesive. Although compatible with numerous indirect restorative materials, there are special instructions for use with light transmissible restorations.

Calibra® Ceram offers simplified clean-up with a wide tack cure window of up to 10 seconds an extended 45-second gel phase, giving you the time you need for a thorough and effective cement clean-up.¹



21% of crown failures are caused by secondary caries due, in part, to excess resin cement.²



- Calibra® Ceram Syringe Combo Kit**
60667382
- 1x 4.5g Calibra® Ceram AutoMix Syringe Shade Translucent
 - 1x 2.5ml Prime&Bond universal™
 - 10x Mixing Tips
 - 50x Flocked Applicator Tips
 - 1x CliXdish® Mixing Well

- Calibra® Ceram AutoMix Syringe Refill**
- 1x 4.5g Calibra® Ceram AutoMix Syringe
 - 10x Mixing Tips
- 607191B Shade Light
 - 607192B Shade Medium
 - 607194B Shade Translucent
 - 607195B Shade Opaque
 - 607196B Shade Bleach

- Mixing Tip Refill**
607086
- 50x Clear Mixing Tips

Try me with...

Prime&Bond universal™ and Celtra® Duo

Calibra® Ceram cement is designed to work better alongside the high bond strength and low film thickness of Prime&Bond universal™ adhesive, without the need for a separate activator. This makes it them the ideal cementation system to use with Celtra® Duo (ZLS) during single-visit dentistry procedures with the CEREC CAD/CAM system.



¹For excess cement cleanup, monowave output LED lights with a single peak output around 470nm are recommended. High power dual or broad spectrum lights may cause premature hardening of excess cement. Check curing light effect on mixed cement in the laboratory prior to clinical use.
²Amani, L. C., Pereira, C. A., Guerra, E., Souza, R., Jorge, A., & Bottino, M. (2012). Morphology and bacterial colonisation of tooth/ceramic restoration interface after different cement excess removal techniques. Journal of Dentistry,40, 742-749.



PERMANENT CEMENTS / AESTHETIC RESIN CEMENT

Calibra® Veneer

The enduring aesthetic veneer cement

Calibra® Veneer aesthetic resin cement is a visible light cured, high strength resin cement compatible with numerous adhesive systems. It is to be used following the application of a suitable adhesive to bond and lute indirect restorations to tooth structure.

Try me with...

Prime&Bond universal™

Ensure uncompromised longevity of your restoration by choosing a high strength adhesive like Prime&Bond universal™.



Calibra® Veneer AutoMix Syringe Kit 607500

- 5x 2g Calibra® Veneer AutoMix Syringe (1 of each shade)
- 5x 1.8g Calibra® Veneer Try-In Paste (1 of each shade)
- 1x 3ml Calibra® Silan Syringe
- 1x 3ml Caulk 34% Conditioner
- 1x 2.5ml Prime&Bond® XP
- 1x 50 Applicator Tips
- 1x 25 Applicator Needles
- 1x CliXdish™
- 1x Light Protection Shield



Calibra® Veneer Try-In Paste Accessory Kit 607300

- 5x 1.8g pastes (1 each shade: Light, Medium, Translucent, Opaque, Bleach)



Calibra® Veneer AutoMix Syringe Refill (1x 2g syringe)

- | | |
|--------|-------------------|
| 607201 | Light Shade |
| 607202 | Medium Shade |
| 607204 | Translucent Shade |
| 607205 | Opaque Shade |
| 607206 | Bleach Shade |



Calibra® Veneer Try-In Paste Refill (2x 1.8g pastes)

- | | |
|--------|-------------------|
| 607301 | Light Shade |
| 607302 | Medium Shade |
| 607304 | Translucent Shade |
| 607305 | Opaque Shade |
| 607306 | Bleach Shade |



PERMANENT CEMENTS / SELF-ADHESIVE RESIN CEMENT

Calibra® Universal

The easy, universal choice

Calibra® Universal self-adhesive resin cement is a two-component, dual cure, high strength self-adhesive cement which contains fluoride. It combines aesthetic shading with a self-etching adhesive, making it suitable for the permanent cementation of metal, PFM, resin/composite, ceramic and porcelain inlays, onlays, crowns and bridges and endodontic posts without application of a separate adhesive bonding agent. Cured Calibra® Universal cement is essentially hydrophobic, minimising post-cure water sorption, solubility and hygro-scopic expansion.

Try me with...

CEREC Zirconia

Calibra® Universal is simple and easy to use with CEREC Zirconia restorations. There's no need to prepare dentin or enamel with an etchant or bonding agent, simply apply Calibra® Universal to the restoration and its ready to seat.



Calibra® Universal AutoMix Syringe Refill

- 2x 4.5g Calibra® Universal AutoMix Syringe
 - 20x Mixing Tips
- | | |
|--------|-------------------|
| 607402 | Shade Light |
| 607403 | Shade Medium |
| 607405 | Shade Translucent |
| 607406 | Shade Opaque |
| 607407 | Shade Bleach |

Mixing Tip Refill

- 607086
- 50x Clear Mixing Tips



PERMANENT CEMENTS / BIOCERAMIC LUTING CEMENT

Calibra® Bio

Bioactive cement. Self-repairing hydroxyapatite (HA) layer. For long lasting marginal integrity, naturally.

Nature knows how to create a better seal. The bioactive chemistry of new Calibra® Bio Bioceramic Cement minimizes microleakage. It adapts seamlessly to the tooth structure and promotes the formation of hydroxyapatite (HA). The result: A good marginal seal, with a self-repairing HA layer that continuously protects marginal integrity, naturally. In a three-year study, Calibra® Bio Bioceramic Cement has been shown to enhance long term marginal integrity with no discoloration, sensitivity, secondary caries or loss of retention. And its unique calcium aluminate ionomer (CAIO) chemistry, combining calcium aluminate and glass ionomers, delivers seamless adaptation towards the tooth structure.

Calibra® Bio Bioceramic Luting Cement makes it easier to achieve successful results:

- Performs in the mouth's naturally moist environment so no priming or bonding agent is needed, saving time and steps
- Good flowability and consistency with low expansion and no shrinkage
- Works well with Zirconia - simple protocol with good retentive strength
- Good retentive strength comparable to self-adhesive resin cements
- Same easy cleanup as other Calibra® cements

Kit

- 607601 Calibra® Bio Bioceramic Luting Cement Intro Kit (with Extruder)
 - 7x Capsules (334mg powder, 196mg liquid each)
 - 1x Capsule Extruder
 - Illustrated Technique Guide
 - Directions For Use
 - Safety Data Sheet



Refill

- 607604 Calibra® Bio Bioceramic Luting Cement Capsule Refill
 - 14x Capsules (334mg powder, 196mg liquid each)
 - Illustrated Technique Guide
 - Directions For Use
 - Safety Data Sheet



Equipment

- 60606596 Capsule Extruder 2
- 5546069 Dentsply Sirona Capsule Mixer (EU version) for the trituration of encapsulated dental restorative materials.



PERMANENT CEMENTS / TRANSLUCENT GLASS-IONOMER LUTING CEMENT

AquaCem®

High compressive strength for effective cementation

AquaCem® is a light-yellow, translucent glass ionomer luting material consisting of a blend of alumino-silicate glass and polyacrylic acid. The powder is mixed with distilled water to produce a luting material which adheres to dentin and enamel producing tightly sealed cementations.



AquaCem® Jar Standard Pack
61119000

- 1x 30g AquaCem® Powder
- 1x Powder Measure
- 1x Water Dispenser

AquaCem® Mixing Pad Refill
60606989

- 1x Glass-Ionomer Mixing Pad



PERMANENT CEMENTS / ZINC PHOSPHATE CEMENT

DeTrey® Zinc

A fine grain zinc phosphate cement

DeTrey® Zinc is a powder-liquid system for manual mixing.

DeTrey® Zinc Jar Refill

- 61113206 1x 90g DeTrey® Zinc Powder, Shade Dentin
- 61113003 1x 39ml DeTrey® Zinc Liquid



PERMANENT CEMENTS / POLYCARBOXYLATE CEMENT

Poly-F® Plus

A water mix polycarboxylate cement powder

Poly-F® Plus is a zinc polycarboxylate cement with freeze dried polyacrylic acid incorporated into zinc oxide powder. The cement is reconstituted by simply adding water in the correct ratio.

Can be used for:

- The cementations of crowns, bridges, inlays and orthodontic brackets
- Cavity lining under all restorative materials
- Temporary fillings and fillings in deciduous teeth

Chemically bonds to the tooth structure whilst being gentle to the pulp.



Poly-F® Plus Jar Standard Pack
61118000

- 1x 50g Poly-F Plus Powder
- 1x Powder Measure
- 1x Water Dispensing Bottle
- 1x Mixing Pad

PROPER EXECUTION OF EACH STEP OF THE CLASS II PROCEDURE IS ESSENTIAL FOR SUCCESS.

By addressing the most vulnerable interface and delivering esthetic results efficiently, you can be more confident that the result will positively impact patient experience and the bottom line of your business.

DENTAL PROFESSIONALS' PRIMARY CONCERNS WHEN PERFORMING POSTERIOR RESTORATIONS¹:

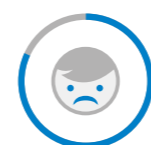

82%
CLINICAL LONGEVITY



81%
MARGINAL INTEGRITY



53%
ADAPTION



40%
ESTHETICS



30%
TIME CONSUMPTION







17%
PROFITABILITY

¹ Dental Products Report April 2015 posterior composite survey



Palodent® V3 Features and Benefits

- 
Feature: 2 NiTi rings with anatomically shaped plastic tines.
Benefit: Outstanding spring strength and memory: Better contact point, less lateral flash, higher longevity. Stable on the tooth.
- 
Feature: Protective WedgeGuards.
Benefit: Protects neighbour tooth during the prep. Turns into a wedge.
- 
Feature: Anatomical wedges for a better seal.
Benefit: Soft wings compress and flare for easy placement, excellent adaptation of matrix band. Gentle to papilla.
- 
Feature: Tabbed contoured matrices for great contacts.
Benefit: Easy to place and remove. Apron for gingival seal. Built-in marginal ridge for occlusal contour. 5 sizes.



MATRIX SYSTEMS / SECTIONAL MATRIX SYSTEM

Palodent® V3

Better outcomes start here

Palodent® V3 is the latest sectional matrix system from Dentsply Sirona. It is dedicated for use in Class II cavities where it delivers predictable, accurate contacts and a natural restoration contour.

The system includes a molar and premolar NiTi ring, 5 different sized tabbed matrix bands, 5 different sized silicone coated matrix bands, 3 wedges, 3 WedgeGuards and specially designed pin-tweezers and forceps. All components work together easily and deliver predictable tight contacts, a tight gingival seal, and a minimised flash and finishing.

Palodent® V3 Matrices EZ Coat have a micro-thin silicone non-stick finish that minimises the chance that bonding agent or composite sticks to the band, making matrix removal easier.

Use the Palodent® V3 system for:

Mesial-occlusal Distal-occlusal Mesial-occlusal-distal

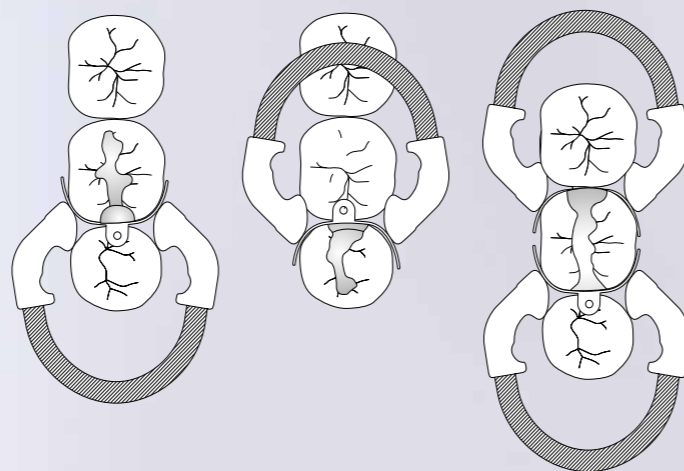

Try me with...

Class II Solution™

Dentsply Sirona provides the only complete solution with unmatched adaptation at each critical step of a Class II restoration. Palodent® V3 can be complemented by using the universal adhesive Prime&Bond universal™, the bulk fill flowable SDR® Plus, and the universal composite Neo Spectra™ ST.



Palodent® V3 Introductory Kit

659700V

- 100x Palodent® V3 Matrices (25x each size: 3.5mm, 4.5mm, 5.5mm, 6.5mm)
- 75x Wedges (25x each size: small, medium, large)
- 30x WedgeGuards (10x each size: small, medium, large)
- 1x Universal Ring
- 1x Narrow Ring
- 1x Forceps
- 1x Pin Tweezers
- 1x Instructions for Use
- 1x Illustrated Technique Guide

Palodent® V3 Starter Kit

62500005

- 20x Palodent® V3 Matrices (5x 4.5mm, 15x 5.5mm)
- 15x Wedges (5x each size: small, medium, large)
- 5x WedgeGuards (medium)
- 2x Universal Ring
- 1x Forceps
- 1x Pin Tweezers
- 1x Instructions for Use
- 1x Illustrated Technique Guide



Palodent® V3 WedgeGuards

- | | |
|---------|--------------------------|
| 659830V | Size Small (50 per box) |
| 659840V | Size Medium (50 per box) |
| 659850V | Size Large (50 per box) |



Palodent® V3 Wedges

- | | |
|---------|---------------------------|
| 659780V | Size Small (100 per box) |
| 659790V | Size Medium (100 per box) |
| 659800V | Size Large (100 per box) |



Palodent® V3 Matrices

- | | |
|---------|--------------------------|
| 659710V | Size 3.5mm (50 per box) |
| 659720V | Size 4.5mm (50 per box) |
| 659730V | Size 5.5mm (50 per box) |
| 659740V | Size 5.5mm (100 per box) |
| 659750V | Size 6.5mm (50 per box) |
| 659860V | Size 7.5mm (50 per box) |



Palodent® V3 Matrices EZ Coat

- | | |
|---------|-------------------------|
| 659610V | Size 3.5mm (50 per box) |
| 659620V | Size 4.5mm (50 per box) |
| 659630V | Size 5.5mm (50 per box) |
| 659640V | Size 5.5mm (90 per box) |
| 659650V | Size 6.5mm (50 per box) |
| 659660V | Size 7.5mm (50 per box) |



Palodent® V3 Ring

- | | |
|---------|-----------------------------------|
| 659900V | Universal Ring Refill (1 per box) |
| 659760V | Universal Ring Refill (2 per box) |
| 659770V | Narrow Ring Refill (2 per box) |

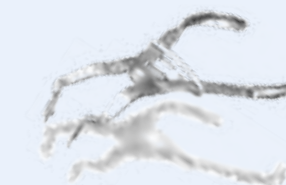

Palodent® V3 Forceps

- | | |
|---------|----------------------------|
| 659810V | Forceps Refill (1 per box) |
|---------|----------------------------|

Palodent® V3 Pin Tweezers

- | | |
|---------|--------------------------|
| 659820V | Pin Tweezers (1 per box) |
|---------|--------------------------|





MATRIX SYSTEMS / CIRCUMFERENTIAL MATRIX SYSTEM

Palodent® 360

Accurate contacts and contours at your fingertips

Provide natural contours and optimal contacts with a simple twist of the fingers—no awkward retainers or applicators required. Choose the Palodent® 360 system for Class II cases where a sectional matrix can't be used and for single-unit crown core build-up procedures.

The integrated tightener/retainer allows matrix placement and retention without the need for bulky retainers or accessory placement and tightener instruments, allowing for efficiency (no set up required), ease of placement, better access, clear view of the operating field and greater patient comfort.

Use the Palodent® 360 system for

Missing cusp

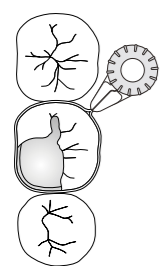

Missing adjacent tooth

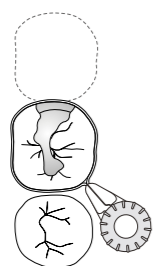

Misaligned tooth

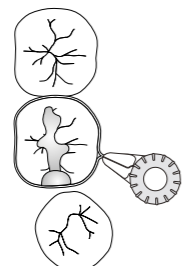

Tooth isolation for core build-up

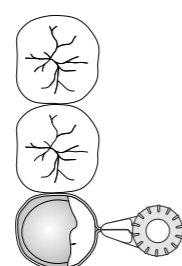

TIP

To seat in tight interproximal spaces, pre-wedge using a Palodent® V3 retaining ring or a wooden wedge to temporarily create the required space.



MATRIX SYSTEMS / CIRCUMFERENTIAL MATRIX SYSTEM

AutoMatrix®

A retainerless matrix system

The circumferential matrix system, AutoMatrix®, allows matrix placement and retention without the need for bulky retainers, allowing for ease of placement, better access, clear view of the operating field and greater patient comfort. The AutoMatrix® matrices are available in four height/width and thickness configurations. All AutoMatrix® matrix sizes fit teeth of any circumference.



AutoMatrix® Starter Kit
62422501

- 24x Medium-Thin Bands
- 24x Medium-Regular Bands
- 24x Narrow-Regular Bands
- 24x Wide-Regular Bands
- 1x Automate® III Tightening Device
- 1x Pair of Snippers



AutoMatrix® Matrices
(72 per pack)

- 62422510 Medium-Thin Bands
- 62422511 Narrow-Regular Bands
- 62422512 Medium-Regular Bands
- 62422513 Wide-Regular Bands



AutoMatrix® Accessories

- 62422601 Pair of Snippers (1 per pack)
- 62422602 AutoMate® III Tightening Device (1 per pack)
- 62422603 Extra Shaft Assembly (1 per pack)
- 62422605 Catch-Tray (10 per pack)

Kit

- 659600V Palodent® Universal Introductory Kit (V3)
 - 24x Palodent® 360 5.5mm
 - 100x Palodent® V3 matrices
 - 75x Palodent® V3 Wedges
 - 30x Palodent® V3 Wedgeguards
 - 2x Palodent® V3 Rings (Universal & Narrow)
 - 1x Palodent® V3 Forceps
 - 1x Palodent® V3 Pin Tweezer

Refills

- 659601 Palodent® 360 Refill 4.5mm
48 per pack
- 659602 Palodent® 360 Refill 5.5mm
48 per pack
- 659603 Palodent® 360 Refill 6.5mm
48 per pack



ADHESIVES / UNIVERSAL ADHESIVE

Prime&Bond universal™

Moisture levels vary. Our bond won't

Prime&Bond universal™ provides well balanced hydrophobic and hydrophilic properties to ensure complete coverage and penetration at varying moisture levels. So even if dentin is overly wet or dry, you get a reliable bond that actively guards against the leading causes of adhesive failure. Prime&Bond universal™ provides:

- Versatility for use with all etching methods and all indications
- Reliable performance on over-wet and over-dried dentin
- Virtually no post-operative sensitivity
- Low film thickness for a reduced risk of pooling and misfit of the restoration
- A relaxed working time and reduced waste, remaining usable for 30 minutes in a closed ClixDish™
- High initial bond strength with Calibra® Ceram cement for indirect restorations
- A patented formulation free of HEMA, TEGDMA, or bisphenol

Indications

- Direct, light-cured composite and compomer restorations
- Composite, ceramic and amalgam repairs
- Cavity varnish for use with fresh amalgam
- Direct restorations cemented with Calibra® Universal and Calibra® Ceram

In combination with Dentsply Sirona's Self Cure Activator:

- Indirect restorations cemented with dual-cure/self-cure resin cements
- Direct dual-cure/self-cure composite restorations and core build up



Features and Benefits

- Feature:** Active moisture control.
Benefit: Reliable bonding performance, no matter if the dentin is still too wet or already too dry - for virtually no post-operative sensitivity.
- Feature:** Active cavity spreading.
Benefit: Actively spreads in the cavity and helps to cover all cavity surfaces.
- Feature:** Self levelling.
Benefit: The adhesive self-levels to form a smooth and uniform adhesive layer, helping to avoid dry spots or adhesive pooling.
- Feature:** Low film thickness.
Benefit: Adhesive pools can show up as translucent areas on a radiograph, which can easily be misdiagnosed as a void. Thick adhesives may also change crown prep geometry impacting crown fit.



Prime&Bond universal™ Bottle Standard Refill
60667350

- 1x 4ml Bottle Prime&Bond universal™
- 1x Instructions for Use
- 1x Illustrated Technique Guide

Prime&Bond universal™ Bottle Mini Refill
60667351

- 1x 2.5ml Bottle Prime&Bond universal™
- 1x Instructions for Use
- 1x Illustrated Technique Guide

ClixDish™ Refill

- 60667346
- 3x ClixDish™



Try me with...

Class II Solution™

When used in conjunction with Palodent® V3, SDR® Plus and Neo Spectra™ ST, dentists can deliver a tight contact point and marginal seal and highly aesthetic results. This portfolio of products work together in harmony allowing you to get your Class II's right the first time.





ADHESIVES / ETCH&RINSE ADHESIVE

Prime&Bond® one Etch&Rinse

The technique tolerant etch&rinse adhesive for all restorations

It is difficult to routinely achieve an optimum level of dentin moisture prior to the application of an adhesive. Over-wet or over-dry dentin can lead to insufficient sealing, resulting in micro leakage and post-operative sensitivity. Prime&Bond® one Etch&Rinse is a technique tolerant solution, providing high bond strength and reliable performance even on over-wet and over-dry dentin.

Dark cure option available for indirect restorations.



- 60667427
- 1x 3.5ml Prime&Bond® one Etch&Rinse
 - 1x 50 Applicator Tips
 - 1x CliXdish™
 - 1x Instructions for Use



ADHESIVES / SELF CURE ACTIVATOR

Self Cure Activator

Suitable for bonding indirect restorations

Self Cure Activator (SCA) is for use with Prime&Bond universal™, Prime&Bond® one Etch&Rinse or Spectrum® bond in conjunction with a dual-cure or self-cure resin cement or restorative such as Calibra® Ceram, Calibra® Universal, SmartCem®2 or Core-X® Flow.

Self Cure Activator combined with the adhesives mentioned above is suitable for bonding of all indirect restorations including metal, porcelain and composite based crowns, inlays, onlays, veneers, bridge retainers and endodontic posts.



- 634354K
- 1x 4.5ml Self Cure Activator
 - 1x Instructions for Use



ADHESIVES / CONDITIONER

DeTrey® Conditioner 36

Phosphoric acid gel for the etching of enamel and conditioning of dentin

DeTrey® Conditioner 36 is a blue-tinted gel containing 36% phosphoric acid for the etching of enamel and conditioning of dentin prior to bonding with resin-based materials.



- DeTrey® Conditioner 36 Syringes**
- 60615208 DeTrey® Conditioner 36 Syringe Refill
- 2x 3ml DeTrey Conditioner 36
 - 25x Applicator Needles

- DeTrey® Conditioner 36 Applicator Needle**
- 60615204 DeTrey® Conditioner 36 Applicator Needle Refill (25 per pack)

- 60615209 DeTrey® Conditioner 36 Syringe Eco Refill
- 10x 3ml DeTrey® Conditioner 36
 - 50x Applicator Needles



ADHESIVES / ACCESSORIES

Applicator Tips

For the application of adhesives

Flocked applicator tips for the application of adhesives.

- 658012 Applicator Tips Refill (50 per pack)
- 60667198 Applicator Tips Refill (100 per pack)



ADHESIVES / ACCESSORIES

CliXdish™

Reusable and reliable

CliXdish™ mixing well is a reusable mixing well that features a unique, ambient-light blocking lid. It protects adhesives and other liquids from ambient light and reduces the evaporation of solvents. The closed lid serves as a rest for in-use storage of an applicator tip or a similar application device.

- 60667346 CliXdish™ Mixing Wells (3 per pack)



FILLING MATERIALS / APPLICATION ACCESSORIES

Compules® Tips Gun

Applicator gun

Applicator gun for all Dentsply Sirona filling materials delivered in Compula® and Compules Tips, notably ceram.x® SphereTEC™ one and SDR® Plus (pages 269 and 271).

- 60665900 Compules® Tips Gun



CURING LIGHTS / MODULAR LED CURING LIGHT

SmartLite® Pro

Clinical performance never looked so good

The new SmartLite® Pro is a unique modular curing device in a remarkable, all-metal housing. It combines an impressive pen-style design with the advantages of a lightweight and well-balanced handpiece. The 360° rotatable tips and the low-profile head guarantees easy clinical access, even in hard to reach areas.

But SmartLite® Pro delivers far more than good looks and ergonomics. State of the art optics with 4 high-performance LEDs and the wide 10mm curing area provide leading quality of cure for reliable clinical outcomes. The ingenious modular concept with exchangeable tips for different clinical indications makes this one of the most versatile dental instruments ever. The additional Transillumination Tip is a diagnostic aid for the visualisation of interproximal caries, evaluation of cracked teeth and the illumination of endodontic access.

SmartLite® Pro comes with a modern-design charging base with a built-in Radiometer and room for extra tips. The intuitive battery management includes two quick connect batteries for constant availability. The intuitive one-button operation with audible and tactile feedback allows the dentist to focus on what really matters.

Kits

- 644400 SmartLite® Pro Introductory Kit
 - 1x Handpiece, 1x Cure Tip, 1x Transillumination Tip, 2x Batteries, 1x Charging Base and Accessories
- 644409 SmartLite® Pro Basic Kit
 - 1x Handpiece, 1x Cure Tip, 2x Batteries, 1x Charging Base and Accessories

Accessories

- 644401 SmartLite® Pro Battery Refill
 - 1x Battery
- 644402 SmartLite® Pro Sleeves Refill
 - 100x Sleeves
- 644403 SmartLite® Pro Eye Protection Shields Refill
 - 5x Shields
- 644404 SmartLite® Pro Power Connector Refill
 - 1x Power Connector
 - 1x Power Cord (USB)
- 644405 SmartLite® Pro Transillumination Tip Refill
 - 1x Transillumination Tip
- 644406 SmartLite® Pro PolyCure Tip Refill
 - 1x PolyCure Tip
- 644407 SmartLite® Pro Cure Tip Refill
 - 1x Cure Tip
- 644408 SmartLite® Pro O-Ring Refill
 - 3x O-Ring





FILLING MATERIALS / BULK-FILL FLOWABLE

SDR® Plus

More shades, more indications, more success

SDR® Plus Bulk-Fill Flowable is a one-component, fluoride-containing, visible light cured, radiopaque resin composite restorative material. It is designed to be used as a base in Class I and II restorations but it is also suitable as a stand-alone restorative material in non-occlusal contact applications. SDR® Plus material has handling characteristics typical of a flowable composite, but can be placed in 4mm increments with minimal polymerisation stress. It provides a simple, fast and efficient filling technique that gives you up to 40% placement time saving versus a layering technique.

Indications

- Base in cavity Class I and II direct restorations
- Liner under direct restorative materials
 - Class II box liner
- Pit and fissure sealant
- Conservative Class I restorations
- Core build-up
- Class III and V restorations

SDR® Plus Collector's Edition 60603048

- 110x SDR® Plus Compulas (70x Universal, 10x A1, 15x A2, 15x A3)
- 4x Storage Boxes



SDR® Plus Compula® Tips Intro Kit 60603047

- 45x 0.25g SDR® Plus Compula® Tips, Shade Universal
- 1x 2.5ml Prime&Bond universal™
- 1x CliXdish™
- 1x Illustrated Technique Guide
- 1x Compules Tips Gun

SDR® Plus Compula® Tips Eco Refill

(50x 0.25g Compula® Tips)
61C103P Shade Universal

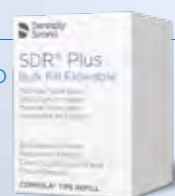

Features and Benefits

- Feature: SDR® Technology.
Benefit: Bulk placement up to 4mm, simple and convenient application and no learning curve.
- Feature: Self-leveling.
Benefit: Excellent cavity adaptation and replaces lining composite.
- Feature: Four shades.
Benefit: Versatility and additional Class III and V indications.
- Feature: Compula® Tip delivery.
Benefit: Precise placement.

SDR® Plus Compula® Tips Refill

(15x 0.25g Compula® Tips)

61C101P	Shade Universal
61C106P	Shade A1
61C107P	Shade A2
61C108P	Shade A3

SDR® Plus Syringe Refill and Eco Refill

(1g Syringes)

61C130P	1x Syringe
60603045	10x Syringe and 60x SDR® Plus Syringe Tips

SDR® Plus Syringe Tips

61C111P 60x Syringe Tips

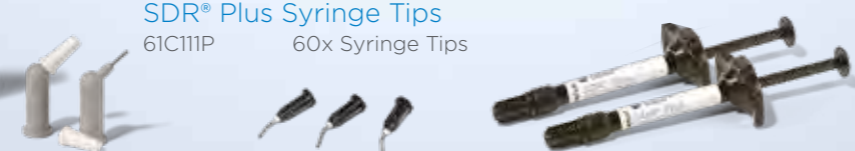

Try me with...

Class II Solution™

When used in conjunction with Palodent® V3, Prime&Bond universal™ and Neo Spectra™ ST, dentists can maintain marginal integrity while also achieving excellent cavity adaption and aesthetic results.



FILLING MATERIALS / UNIVERSAL COMPOSITE RESTORATIVE

Neo Spectra™ ST

Your most common cases, covered

Our decades of innovation in composite materials taught us what matters most to dentists. Neo Spectra™ ST is the successor of ceram.x® SphereTEC™ one, now a complete portfolio covering the full range of handling preferences and aesthetic needs with a single product line. SphereTEC® filler technology offers optimised performance in the areas that matter most, helping clinicians to achieve reliable, aesthetic results efficiently.

What's new

Two universal composite handling options

Neo Spectra™ ST composite offers optimised handling in a creamy and spreadable Low-Viscosity (LV) or a firm and packable High-Viscosity (HV) to accommodate your preference and technique for placement efficiency.

Features and Benefits

- Feature: Novel SphereTEC™ filler technology.
Benefit: Exceptional handling comfort!
Easy to adapt to cavity walls, margins and surfaces, no stock to the hand instrument, precise to sculpt, slump resistant and easy to extrude.
- Feature: Extremely simple Cloud shade concept.
Benefit: Exciting clinical results made easy.
- Feature: Fast and easy polishing.
Benefit: Extra glossy.
- Feature: Great mechanical properties.
Benefit: Excellent choice for long-lasting restorations.



HV Syringe Refills

1x 3g per pack
60701981 Shade A1
60701982 Shade A2
60701983 Shade A3
60701985 Shade A3.5
60701984 Shade A4

HV Kits

60701970 Compules® Tips Intro Kit (HV)
24x HV Compules® Tips (Gray) Assorted - (0.25g each) (4x A1, 4x A2, 8x A3, 4x A3.5, 4x A4), 1x Compules® Tips Gun, 1x i-shade label, 1x Prime&Bond Universal™ Adhesive (2.5ml bottle), Accessories

Syringe Intro Kit (HV)

60701980
5x HV Syringes (Gray) Assorted - (3g each), (A1, A2, A3, A3.5, A4), 1x i-shade label, 1x Prime&Bond Universal™ Adhesive (2.5ml bottle), Accessories

Syringe Eco Kit (HV)

60701990
6x HV Syringes (Gray) Assorted - (3g each), (3x A2, 3x A3), 1x i-shade label, 1x Prime&Bond Universal™ Adhesive (2.5ml bottle), Accessories

HV Compules® Tips Refills

16x 0.25g per pack
60701971 Shade A1
60701972 Shade A2
60701973 Shade A3
60701976 Shade BW



LV Syringe Refills

1x 3g per pack
60701881 Shade A1
60701882 Shade A2
60701883 Shade A3
60701885 Shade A3.5
60701884 Shade A4

LV Kits

60701870 Compules® Tips Intro Kit (LV)
24x LV Compules® Tips (Blue) Assorted - (0.25g each) (4x A1, 4x A2, 8x A3, 4x A3.5, 4x A4), 1x Compules® Tips Gun, 1x i-shade label, 1x Prime&Bond Universal™ Adhesive (2.5ml bottle), Accessories

Syringe Intro Kit (LV)

60701880
5x LV Syringes (Blue) Assorted - (3g each), (A1, A2, A3, A3.5, A4), 1x i-shade label, 1x Prime&Bond Universal™ Adhesive (2.5ml bottle), Accessories
60701890 Syringe Eco Kit (LV)
6x LV Syringes (Blue) Assorted - (3g each), (3x A2, 3x A3), 1x i-shade label, 1x Prime&Bond Universal™ Adhesive (2.5ml bottle), Accessories

LV Compules® Tips Refills

16x 0.25g per pack
60701871 Shade A1
60701872 Shade A2
60701873 Shade A3
60701876 Shade BW

Try me with...

Class II Solution™

The Class II Solution™ is our filling concept designed to help you deliver smooth, contoured surfaces and simplified shade matching for your Class II restorations. Explore all the benefits of these system components today: Palodent® V3, Prime&Bond universal™, and SDR® Plus.





FILLING MATERIALS / UNIVERSAL COMPOSITE RESTORATIVE

Neo Spectra™ ST Effects

Complex anterior cases, simplified

Neo Spectra™ ST material also offers a simplified shading system comprised of 5 Universal CLOUD shades that cover the entire VITA® based shade system, to satisfy the aesthetic demands for most cases with a single shade. For aesthetically demanding anterior cases, Neo Spectra™ ST Effects offers two opaque dentin shades and one translucent enamel shade that work together in a simplified layering technique with universal CLOUD shades.

Effects Syringe Refills (HV only)

1x 3g per pack

60701952	Shade D1
60701953	Shade D3
60701951	Shade E1



FILLING MATERIALS / FLOWABLE COMPOSITE RESTORATIVE

Neo Spectra™ ST flow

Efficient aesthetic flowable versatility

Neo Spectra™ ST flow material enables the aesthetic performance and durability you expect from a SphereTEC® based composite in flowable form. For applications where higher flowability is preferred, the nanofillers in Neo Spectra™ ST flow help to create a versatile, thixotropic 'flow on-demand' handling that stays put until the user initiates the flow. The flow viscosity offers proven durability, excellent chameleon blending ability, high polish and stain resistance.

Flow Syringe Refills

2x 1.8g syringes, 25x syringe tips per pack

60701921	Shade A1
60701922	Shade A2
60701923	Shade A3
60701925	Shade A3.5
60701924	Shade A4
60701926	Shade BW

60701928	Shade D1
60701929	Shade D3
60701927	Shade E1

Accessories

60701932	Syringe Tips Refill (50 tips per pack)
----------	---



FILLING MATERIALS / UNIVERSAL COMPOSITE

Spectrum®

Universal Microhybrid Composite Restorative

Spectrum® offers a complete system approach to composite restoratives. A high quality composite material with excellent resistance to wear and precise VITA® shading. It now has improved polishability and is indicated for all cavity classes in anterior and posterior teeth.

With more than 18 years of clinical experience, Spectrum® has proven itself as a reliable partner for everyday aesthetics. The enamel like luster mimics that of the natural tooth, resulting in predictable and long lasting aesthetic restorations. Spectrum® allows for easy handling thanks to its creamy non-sticky consistency, excellent adaptability and innovative syringe, which has been ergonomically designed so less extrusion power needed and enables durable laser marking.



Spectrum® Syringe Starter Kit

60605280

- 7x 4g Spectrum® Syringes (shades A1, A2, A3, A3.5, O-A2, O-A3.5, B2)
- 1x 3.5ml Spectrum® bond
- 1x DeTrey® Conditioner 36
- 1x 50 Applicator Tips
- 1x 25 Applicator Needles
- 1x Instruction for Use

Spectrum® Syringe Refill

(1x 4g Syringe)

60605281	Shade A1
60605282	Shade A2
60605283	Shade A3
60605284	Shade A3.5
60605286	Shade B1
60605287	Shade B2
60605292	Shade O-A2
60605293	Shade O-A3.5



FILLING MATERIALS / UNIVERSAL COMPOSITE

Esthet-X® HD

Composite with a newly optimised filler particle distribution

Esthet-X® HD high definition micro matrix restorative is a visible light-cured, radiopaque, composite restorative material that is re-defined to present the ideal combination of beauty and strength for anterior and posterior restorations.

With a newly optimised filler particle distribution, Esthet-X® HD provides:

- Faster, brilliant, and long lasting polish
- Outstanding physical properties
- Ideal handling characteristics
- Comprehensive shade and opacity selection

Esthet-X® HD Compule Refill

(20x 0.25g Compules Tips per pack)

630617	Shade A1
630618	Shade A2
630619	Shade A3
630620	Shade A3.5
630622	Shade B1
630623	Shade B2
630627	Shade C2
630633	Shade Universal
630615	Shade White



Esthet-X® HD Compule Refill

(10x 0.25g Compules Tips per pack)

630621	Shade A4
630624	Shade B3
630626	Shade C1
630628	Shade C3
630629	Shade C4
630631	Shade D2
630632	Shade D3
630616	Shade Extra Light
630625	Shade Dark Yellow
630630	Shade Extra Grey Brown
630610	Shade Clear Enamel
630611	Shade White Enamel
630613	Shade Amber Enamel
630612	Shade Yellow Enamel
630614	Shade Grey Enamel
630634	Shade WO



Esthet-X® HD Syringe Refill

(1x 3g syringe)

630650	Shade Clear Enamel
630651	Shade White Enamel
630652	Shade Yellow Enamel
630653	Shade Amber Enamel
630654	Shade Grey Enamel
630655	Shade White
630656	Shade Extra Light
630657	Shade A1
630658	Shade A2
630659	Shade A3
630660	Shade A3.5
630661	Shade A4
630662	Shade B1
630663	Shade B2
630664	Shade B3
630665	Shade Dark Yellow
630666	Shade C1
630667	Shade C2
630668	Shade C3
630669	Shade C4
630670	Shade Extra Grey Brown
630671	Shade D2
630672	Shade D3
630673	Shade Universal
630674	Shade WO
630675	Shade A2-O
630676	Shade A4-O
630677	Shade B2-O
630678	Shade C1-O
630679	Shade C4-O
630680	Shade D3-O

THE DENTAL
SOLUTIONS
COMPANY™

**Dentsply
Sirona**

what progress looks like.

Once, maybe twice in a generation, a restorative material comes along that changes the rules of dentistry. This is that material. This is that time.

- No etching, no bonding, no layering
- Faster than composite
- As durable as composite

Surefil one™.

Helping you shape
the future of dentistry.

For more information
visit [DentsplySirona.com](https://www.DentsplySirona.com)

Surefil one™

Self-Adhesive Composite Hybrid

ML450001A

©2020 Dentsply Sirona. All rights reserved.



FILLING MATERIALS / SELF-ADHESIVE COMPOSITE HYBRID

Surefil one™

One material does it all

Surefil one™ Self-Adhesive Composite Hybrid is a dual-curing, permanent restorative for stress-bearing, tooth coloured restorations (class I, II and V) and core-build up. Surefil one™ connects efficiency and performance, delivering every advantage in one material:

- Self-adhesive: no etching, bonding or cavity conditioning
- As durable as composite
- Faster than composite
- Dual cure initiators allow bulk-fill to unlimited depth
- Ideal for compromised situations
- Releases fluoride



Kits

- 60300200 Surefil one™ Intro (incl. 1 Extruder each)
- 10x Capsules A1
 - 20x Capsules A2
 - 20x Capsules A3
 - 10x Capsules BW
 - 1x Capsule Extruder
 - ITG/IFU

Refills

- 60300211 Surefil one™ Refill A1
- 16x Capsules A1
- 60300212 Surefil one™ Refill A2
- 16x Capsules A2
- 60300213 Surefil one™ Refill A3
- 16x Capsules A3
- 60300215 Surefil one™ Refill A3.5
- 16x Capsules A3.5
- 60300216 Surefil one™ Refill BW
- 16x Capsules BW
- 60300302 Surefil one™ Eco Refill A2
- 50x Capsules A2
- 60300303 Surefil one™ Eco Refill A3
- 50x Capsules A3

Equipment

- 60606596 Capsule Extruder 2
- 2770000000 Promix one EU (220-240V 50HZ)
- 2770002000 Promix one EXP 2 (220-240V 60HZ)



Fast and efficient

Less steps mean...

- Less complexity
- Less room for contamination with saliva and blood
- Less room for mistakes
- Less reasons for post-operative sensitivity
- Shorter treatment time
- Higher patient comfort



4 simple steps

Traditional composite procedure

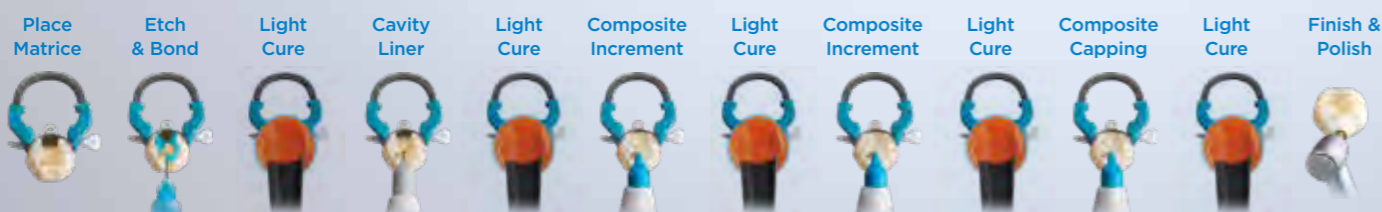

FILLING MATERIALS / POSTERIOR COMPOSITE

QuiXfil®

Speed. Durability. Pleasure

QuiXfil® is a resin-based restorative material specially designed for posterior use. QuiXfil® allows a simplified and fast application technique without compromising safety and efficacy.

QuiXfil® utilises a special filler technology resulting in a unique high filler load. It exhibits wear resistance and physical properties suitable for occlusal stress-bearing restorations.

QuiXfil® is available in pre-dosed Compules Tips for direct intra-oral use and is available in one one universal shade.



QuiXfil® Compules Tips Non-EU Refill

- (20x 0.28g Compules)
- 60605608 Shade Universal

QuiXfil® Compules Tips Eco Refill

- (100x 0.28g Compules)
- 60605670 Shade Universal



FILLING MATERIALS / COMPOMER

Dyract® XP

The caries preventing restorative

Dyract® XP is a light-curing restorative material for all cavity classes in anterior and posterior teeth. It combines the fluoride release of glass ionomer materials with the strength, longevity and aesthetics of a light-curing composite.

Restorations made with Dyract® XP continuously release fluoride ions, which act on the tooth restoration interface as an acid buffer and effectively supports the prevention of approximal caries. The choice of Dyract® XP restorative for patients prone to risk of caries is therefore advisable as an additional care against the onset of new caries.

Dyract®XP has more than 20 years of experience and clinical success are documented in 45 clinical investigations and over 500 scientific publications.

Dyract® XP Intro Kit

- 60604210
- 40x 0.25g Compules Tips (10x A2, 15x A3, 10x A3.5, 5x B1)
 - 1x Compules® Tips Gun
 - 1x 3.5ml Prime&Bond® NT
 - 50x Applicator Tips
 - 3x Applicator Dishes



Dyract® XP Compules Tips Refill

- (20x 0.25g Compules)
- 60604275 Shade A2
- 60604276 Shade A3
- 60604277 Shade A3.5
- 60604278 Shade B1





FILLING MATERIALS / CLASSIC GLASS IONOMER

ChemFil® Rock

Unique zinc-reinforced glass ionomer

Sculpt Immediately

ChemFil® Rock delivers a non-sticky, packable formula and sculptable consistency, plus fluoride release and good radiopacity.

Simple

ChemFil® Rock offers bulk placement and self-cure setting. No cavity conditioning or surface coat needed which saves time, effort and material cost.

Strong

Up to 25%¹ higher strength compared with other glass ionomers – ChemFil® Rock has proven to demonstrate earlier build-up to fracture toughness within the first few crucial hours and superior wear resistance under simulated clinical conditions leading to longer lasting, higher quality restorations.

ChemFil® Rock Intro Kit

60606590

- 40x Capsules (10x each – A1, A2, A3 and Contrast White)
- 1x Capsule Extruder
- 1x Directions for Use



ChemFil® Rock Refills

(50x Capsules)

- 60606591 A1
- 60606592 A2
- 60606593 A3
- 60606594 A4-O
- 60606595 Contrast White



FILLING MATERIALS / CLASSIC GLASS IONOMER

ChemFil® Superior

Fast setting glass ionomer restorative material

ChemFil® Superior is a fast-setting glass ionomer restorative material consisting of a blend of alumino silicate glass and polyacrylic acid. The powder is mixed with distilled water to produce a filling material which adheres to dentin and enamel producing tightly sealed, strong and aesthetic restorations.

ChemFil® Superior Intro Pack

60606515

- 7x 10g ChemFil® Superior Powder Shades: L, LYG, LY, DY, DG, LG, GB
- 1x 12.5ml ChemVarnish®
- 1x 6ml ChemFil® Tooth Cleanser
- 1x Shade Guide
- 1x Water Dispensing Bottle
- Accessories



ChemFil® Superior Refill

(includes powder measure and water dispensing bottle)

- 60606520 Shade L = Light
- 60606530 Shade LYG = Light Yellow Grey
- 60606540 Shade LY = Light Yellow
- 60606550 Shade DY = Dark Yellow
- 60606560 Shade DG = Dark Grey
- 60606570 Shade LG = Light Grey
- 60606580 Shade GB = Grey Brown



FINISHING AND POLISHING / FINISHING SYSTEM

Enhance®

Coarse when you need it, fine when you want it

The Enhance® finishing system accomplishes the entire process of excess removal, contouring, and finishing simply by varying the pressure. Push harder to remove excess composite, ease it off for final results. In just one step the Enhance® finishing system delivers a smooth, contoured surface with a natural looking finish.



Enhance® System Kit

624075

- 20X Enhance® Finishing Discs
- 10X Enhance® Finishing Points
- 10X Enhance® Finishing Cups
- 25X Prisma® Gloss Polishing Cups
- 1X Metal Mandrel
- 1 X4g Prisma® Gloss Composite Polishing Paste
- 1X 4G Prisma® Gloss Composite Polishing Paste extra fine

Enhance® Refill

(30x per pack)

- 624045X Enhance® Finishing Discs
- 624055X Enhance® Finishing Cups
- 624065X Enhance® Finishing Points



Try me with...

Class II Solution™

When used in conjunction with Palodent® V3, SDR® Plus and Neo Spectra™ ST, dentists can deliver a tight marginal seal and highly aesthetic results. This portfolio of products work together in harmony allowing you to get your Class II's right the first time.





FINISHING AND POLISHING / POLISHING SYSTEM

Enhance® PoGo®

Polish and go!

Enhance® PoGo® polishers are pre-mounted, single-use diamond polishing devices designed for use in the final polishing of all accessible composite resin and compomer restorations. For optimal surface polish, follow the use of Enhance® with Enhance® PoGo® polishers.

Enhance® PoGo® Refills

662010Y	Disc Refill (30 per pack)
662022Y	Point Refill (30 per pack)
662023Y	Cup Refill (30 per pack)
662025Y	Combo Refill (30 per pack) (10 of each type)



FINISHING AND POLISHING / COMPOSITE POLISHING PASTE

Prisma® Gloss™

Produce a natural, 'microfine' finish

Prisma® Gloss™ Composite Polishing Pastes are water-soluble, aluminum oxide pastes designed for final polishing of anterior and posterior composite restorations, diastema closures, aesthetic incisal lengthenings or veneers.

When applied with the Foam Polishing Cup, Prisma® Gloss™ Polishing Paste improves the smoothness of the finished surface of microfil composites to a final, high luster surface, or pre-polishes by smoothing finished surfaces of hybrid and micro-hybrid composites to low luster.

Prisma® Gloss™ Syringe Paste Refill (1x 4g Syringe)

631400	Prisma® Gloss™ Syringe Paste Regular
631450	Prisma® Gloss™ Syringe Paste Extra Fine

Prisma® Gloss™ Polishing Cup Refill

624020	<ul style="list-style-type: none"> 100x Polishing Cups 1x Mandrel for use with Prisma® Gloss™ Polishing Paste
--------	---

Prisma® Gloss™ Metal Mandrel Refill

624025	Metal Mandrel for Prisma® Gloss™ (3 per pack)
--------	---



LINERS / CALCIUM HYDROXIDE LINER

Dycal®

Radiopaque calcium hydroxide composition

Dycal® calcium hydroxide liner is a two-component, rigid-setting, self-curing material designed for use in direct and indirect pulp capping and as a protective liner under dental adhesives, varnishes, filling materials, cements, and other base materials. It will not inhibit the polymerisation of acrylic and composite restorations.



Dycal® Tube Refill

(1x 13g Dycal® Base Paste, 1x 11g Dycal® Catalyst Paste)

623401Y	Shade Ivory
623451Y	Shade Dentin

Dycal® Mixing Pad

61105990	Dycal® Mixing Pad (3.5cm x 4.5cm) (12 per pack)
----------	---



INTERMEDIATE RESTORATIVES / ZINC-OXIDE EUGENOL

IRM®

Designed to be temporary

IRM® restorative is a polymer-reinforced zinc oxide-eugenol composition restorative material designed for intermediate restorations intended to remain in place for no longer than one year.

IRM® restorative may also be used as a base under restorative materials and cements that do not contain resin components.

IRM® is available as caps for use with machine mixing.



610003	IRM® Powder Refill (1x 38g bottle)
610004	IRM® Liquid Refill (1x 14ml bottle)
610007	IRM® Standard Package (1x 38g ivory powder bottle, 1x 14ml liquid bottle)
610200	IRM® Caps Standard Pack (50x 0.35g caps)
60661500	IRM® Refill (1x40g bottle)

AMALGAMS / **DISPERSED PHASE AMALGAMS**

Dispersalloy®

Dispersed phase alloy

A dispersed phase admix amalgam, containing lathe-cut particles and silver/copper eutectic spheres.



Dispersalloy® Capsule Refill
(50x Dispersalloy® Capsules, Regular Set)

66002891	1 Spill
66002892	2 Spill
66002893	3 Spill

Dispersalloy® Capsule Refill
(50x Dispersalloy® Capsules, Fast Set)

66002861	1 Spill
66002862	2 Spill
66002863	3 Spill

AMALGAMS / **SPHERICAL AMALGAMS**

Megalloy® EZ

Spherical alloy self-activating capsule

Megalloy® EZ Spherical Alloy is a high strength, high copper, spherical amalgam.

Megalloy® EZ Capsule Refill
(50x Megalloy® EZ Self-Activating Capsules)

66003004	1 Spill
66003005	2 Spill
66003006	3 Spill

Megalloy® EZ Capsule Eco Refill
(250x Megalloy® EZ Self-Activating Capsules)

66003014S1	1 Spill
66003015S1	2 Spill
66003016S1	3 Spill

AMALGAMS / **ACCESSORY**

ProMix™ 2

High speed capsule mixer

Universal high speed capsule mixer with a high precision microprocessor controlled timer providing consistent and accurate mixing, ensuring the optimal handling and clinical characteristics of mixed materials. The capsule mixer is designed for the mixing of any encapsulated dental restorative materials.

- Simple to use
- Consistent and accurate trituration
- Robust and reliable: 5 year warranty

Technical data:

Mixing times:	0 - 16 sec
Mixing frequency:	4,600 oscillations/min
Width, Depth, Height:	217mm, 173mm, 180mm

ProMix™ 2 Mixing Machine Unit (1x Unit)
60606662 EU Version



CLINICAL PERFORMANCE NEVER LOOKED SO GOOD.

NEW! SmartLite® Pro
Modular LED Curing Light

We weren't satisfied with creating one of the most advanced curing lights ever. It had to be one of the best-designed as well. The SmartLite® Pro light is a unique modular curing device in a remarkable, all-metal housing. But it delivers far more than good looks. State of the art optics provide leading quality of cure for reliable outcomes. And the modular concept with exchangeable tips makes this possibly one of the most versatile dental instruments you'll ever own. SmartLite® Pro. **Designed to perform.**

Innovative CAD/CAM and Digital Dentistry Solutions

The future of dentistry is digital. The demand for advanced technology in the dental sphere by patients is increasing, with patients wanting more forward-thinking treatment options. Technologies such as CAD/CAM have created a new standard of care that caters to consumers seeking better and faster treatment. CAD/CAM works - It is faster, more economical, predictable, consistent, and accurate. When properly implemented, the return on investment with digital dentistry can be excellent.



Contents



CEREC

Primescan	244
Acquisition Center	245
Omniscam	246
Omniscam AC and Omniscam AF	247
Connect Case Center	248
CEREC Software	249
CEREC Primemill	250
CEREC SpeedFire	253
The integrated CEREC practice	254
CEREC Chairside Implantology	256
From the practice to the lab	258
From the practice to specialized partners	260
Digital Intraoral Monitoring	262

Data Backup Solution

Hub	263
-----	-----

CAD/CAM for the Dental Practice

CEREC Chairside Solutions

The latest generation of our CEREC system sets new standards so you can offer patients an unmatched combination of single-visit dentistry and excellent quality. After 35 years of continuous optimization, CEREC gives you the options you need to treat multiple indications with the confidence that comes from outstanding results.

The CEREC system comprises world-class components that interact perfectly ensuring seamless workflows. CEREC Primescan quickly delivers highly accurate scan data to the new CEREC Software 5, supporting you with patient-specific proposals based on the patented biojaw algorithm. The powerhouse of the system is the new CEREC Primemill. With this state-of-the-art milling unit, digital chairside dentistry is faster, easier and more reliable than ever before. Zirconia restorations can also be sintered and glazed in the CEREC Speedfire furnace right in you practice. It now comes with a new pre-heating function and updated design features in black and white.

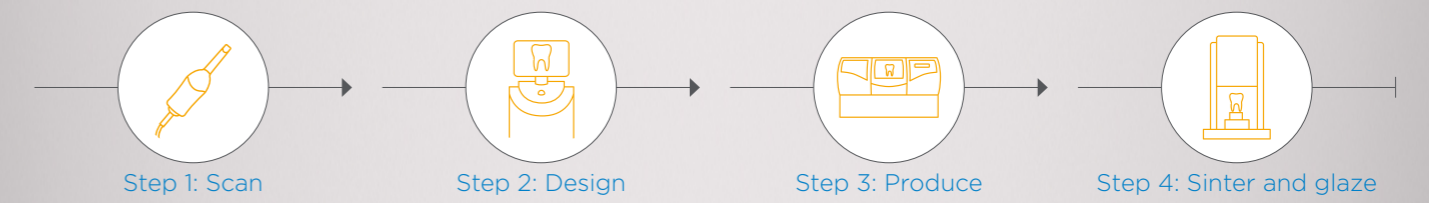

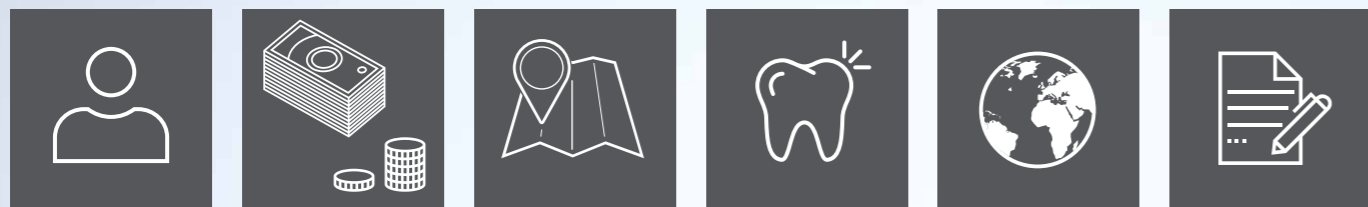

Two thirds of patients would change their dentists in order to receive single visit dentistry.*

50% of patients would be willing to pay more for single visit dentistry.*

Two thirds of patients would travel further for single visit dentistry.*

95% proven long-term stability with CEREC.**

Every 5 seconds a CEREC restoration is placed somewhere in the world.

> 250 scientific studies have proven the clinical safety of CEREC.

CEREC solutions for different workflows

And today, there's even more to CEREC than just single visit dentistry. The CEREC solution spectrum now covers three key areas: restorative, implantology and orthodontics, not only for chairside but also for clinic-to-laboratory workflows. Taking a digital impression with the intraoral scanner CEREC Omnicam is always your first step, no matter which CEREC workflow solution you are following. From there it is up to you to take the next step. With CEREC you are outfitted for the treatments of today and the future.

Be free to choose just what you need and discover your way of using CEREC:



* Source: Exevia GmbH dental patient survey, November 2015.
 ** Source: Posselt, Kerschbaum, Longevity of 2328 chairside CEREC Inlays and Onlays, Int J Comput Dent. (2003).



Are you ready for CEREC?

For CEREC users, it's simple: CEREC makes even the best dentists better. So going digital was a great decision, but until they did it they too had their doubts. Would everything go smoothly straight away? **No.** Could they learn to handle the technology? **Absolutely.** What about the quality of restorations? **Outstanding in every way.**

There's never been a better time to future-proof your practice with CEREC. Join us at your local CEREC event and test it yourself.

The all-new CEREC. **Now is the time.**

Learn more at: dentsplysirona.com/cerecprimemill

THE DENTAL SOLUTIONS COMPANY™





CEREC / INTRAORAL SCANNER

Primescan

Enjoy the scan

An excellent choice for outstanding results: CEREC Primescan is your perfect starting point into digital dentistry. No matter how you would like to design your workflows, CEREC Primescan is the enabler for efficient digital workflows – both chairside in your practice and with your preferred partners.

Accuracy. Usability. Speed.

What you see is what you get

The innovative Smart Pixel Sensor processes more than 1,000,000 3D points per second, producing photorealistic and highly accurate data. In certain aspects, Primescan was viewed as the most accurate among the tested intraoral scanners that were compared in an in-vitro study*. Its dynamic depth scan technology enables perfect sharpness and outstanding precision, even at a measuring depth up to 20 mm – a crucial advantage for subgingival indications. Due to CEREC Primescan's ability to scan at an incredible data density, it delivers complete 3D structures of everything in its field of view – from the very first scan.

* Ender et al, Accuracy of complete- and partial-arch impressions of actual intraoral scanning systems in-vitro, Int J Comput Dent 2019; 22(1): 11-19; in the peer group of intraoral scanners, which did not cover several systems commercially available today, Primescan showed the best median and mean values across complete arch, anterior and posterior segments, few statistical limitations apply

Start scanning right away

CEREC Primescan offers continuous self-heating for fog-free scanning – which means you're always ready to go. Steep angles? Hard-to-access areas? Shiny materials? An easy job for CEREC Primescan. Thanks to the increased field of view, you'll be able to visualize larger areas with less scanner movement. The excellent scan results are instantly displayed on the touchscreen of the new Acquisition Center.

Take control of infection

Three different sleeves guarantee that you'll fulfill your practice needs as well as all general hygiene requirements. Choose from stainless steel sleeves with either sapphire glass or as an autoclavable option. Single-use disposable sleeves are also available.

Accelerate the process

CEREC Primescan's unique technology allows for easy capturing and quicker processing of more data in higher resolution. Intelligent processing in CEREC Primescan ensures optimum interaction with the software by transmitting exactly the data the software needs to proceed. The result: complete 3D-scan models are displayed immediately, no matter how fast you scan.

Enhance your connectivity

Thanks to validated and open data transfer options, laboratories and other partners receive high-resolution models in an instant. With CEREC Primescan, you benefit from the freedom to make the best choice of workflows for you and your patients.



Primescan

6692672 with

- Primescan scanner
- Integrated special PC
- Touchpad
- WLAN card
- Windows 10, 64 bit
- 21.5" TFT LED touch monitor
- License stick (with Connect license)
- Connect software installed (license included)
- Connect Case Center Inbox license included
- STL Export included

CEREC Primescan AC

6622000 with

- CEREC Primescan scanner
- Integrated special PC
- Touchpad
- Radio module to connect with the CEREC milling units
- WLAN card
- Windows 10, 64 bit
- 21.5" TFT LED touch monitor
- License stick (with Connect license)
- Connect software installed (license included)
- CEREC software installed (license included)
- Connect Case Center Inbox license included
- Open Scan Export license included

CEREC Pro Module

6695626

Accessories for CEREC Primescan AC, Primescan AC

- | | |
|---------|--|
| 6622075 | Rechargeable battery |
| 6686880 | CEREC Primescan / Primescan disposable sleeve (50 pcs) |
| 6683184 | CEREC Care HLD Set Primescan |

Acquisition Center



The touchscreen interface enables intuitive operation.

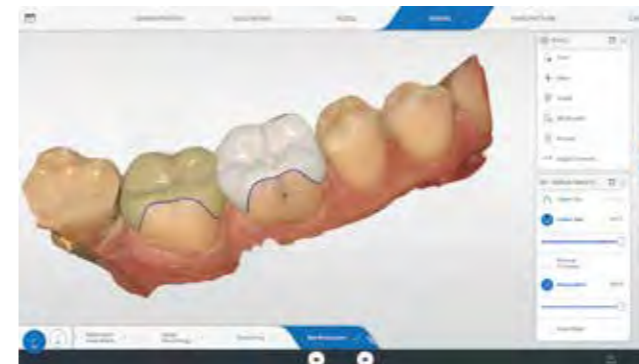

The new CEREC software offers photorealistic presentations.



The battery capacity also makes it suitable for mobile use.

Touchscreen

Use customary touchscreen gestures naturally and intuitively operate the software. The smooth surfaces of the acquisition unit are particularly easy to clean and disinfect.

In contrast to a regular laptop, CEREC Primescan AC may be placed right next to the patient as an approved medical device.

Ergonomics and design

The modern, elegant design of the CEREC Primescan AC and CEREC Omnicam AC meets the highest aesthetic and functional standards. The large touchscreen with glass surface can be moved in all directions to enable ergonomic work in every position as well as comfortable patient communication.

Battery buffer allows for full mobility between treatment rooms and enables over 60 minutes of scanning without external power source.



CEREC / INTRAORAL SCANNER

Omniscam

Reliable performance

The proven Omniscam is a viable alternative to the new Primescan high-performance scanner. Omniscam is still among the smallest available scanners on the market. That makes it particularly comfortable to handle; it scans without powder and in color. Omniscam has won 40.000 users worldwide since 2012 and is always up to date with continuous software updates. Omniscam is one of the most sold intraoral scanners of all time and is used for more than 7 million digital impressions per year.



Since its launch CEREC Omniscam has set standards. Thanks to continuous software updates, it remains competitive to this day.



CEREC / INTRAORAL SCANNER

Omniscam AC and Omniscam AF

All the benefits of Omniscam - your way



Now you have the option of taking the Omniscam with the new Acquisition Center (AC) or the flexible tabletop unit (AF).

The **Omniscam AC** includes a workstation designed for modern dentistry and with the dentist in mind. It comes with a touchpad and a 16:9 wide-format movable touchscreen, offering you a highly intuitive and ergonomic work platform.

The **Omniscam AF** comprises the individual components of Omniscam including camera tray and PC.

The camera can be easily taken from one treatment room to another - a big advantage for joint practices and practices with several locations. Scanning and designing can be done separately. For example, you can make the design in the first treatment room and your assistant or colleague can start a new scan in the next one.

Omniscam AC

6692680 with:

- Omniscam scanner
- Integrated special PC
- Touchpad
- WLAN card
- Windows 10, 64 bit
- 21.5" TFT LED touch monitor
- License stick (with Connect license)
- Connect software installed (license included)
- Inbox license included
- Open Scan Export license included.



Omniscam AF

6564715 with:

- Omniscam
- Scanner holder with table base
- Special PC (mid-tower size - 180 mm x 43 mm x 489 mm)
- WLAN card
- Windows 10, 64 bit
- Input device (wireless keyboard and mouse)
- License stick (with Connect license)
- Connect software not pre-installed.
- Connect Case Center Inbox Licence included
- Remote software
- Connecting cable for Scanner holder (3 m, 5 m, or 10 m)



CEREC Omniscam AC

6622299 with:

- CEREC Omniscam scanner
- Integrated special PC
- Touchpad
- Radio module to connect with the CEREC milling units
- WLAN card
- Windows 10, 64 bit
- 21.5" TFT LED touch monitor
- License stick (with Connect license)
- Connect software installed (license included)
- CEREC software installed (license included)
- Inbox license included
- already allows the export of STL files

CEREC Omniscam AF

6532076 with:

- CEREC Omniscam
- Camera holder with table base
- Special PC (mid-tower size - 180 mm x 435 mm x 489 mm)
- WLAN card
- Windows 10, 64 bit
- Input device (wireless keyboard and mouse)
- Sirona Remote software
- CEREC SW (License)
- License stick (with Connect license)
- Connect Case Center Inbox License included
- Connecting cable for camera holder (3 m, 5 m, or 10 m)



CEREC / INTERNET SOFTWARE AND PORTAL

Connect Case Center

The central platform for digital impressions

Practices and laboratories have to register just once in order to transmit digital orders via the portal to dental laboratories simply and safely within seconds. Every dental laboratory that registers once for the Connect Case Center can be found by practices, saved permanently as the preferred lab and contacted for Connect orders.

CEREC digital impressions were used by labs to produce over one million restorations last year.

Benefits for the dental practice

- Patient-oriented modern treatment concept
- Exceptional treatment comfort: Patients do not experience the urge to gag
- Very user-friendly
- Precise and rapid procedure: Simply take the impression and send
- Ideal integration in the practice workflow and subsequent laboratory commissioning
- Proven laboratory quality for the well-being of the patient

The Connect Case Center is available with all models of the CEREC Omnicam. Please refer back to page 171 for item references.

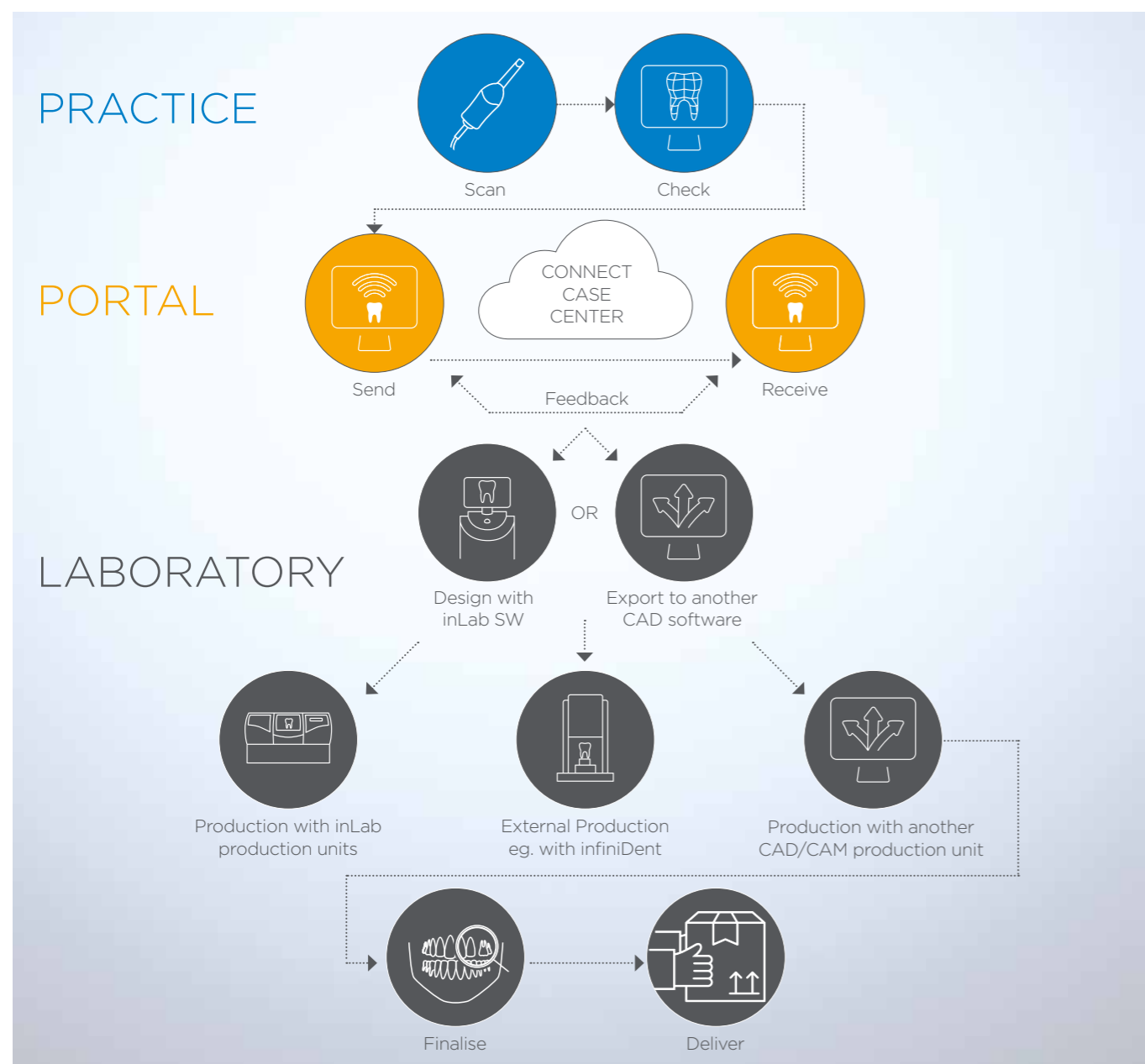

CEREC / SOFTWARE

CEREC Software

A new software generation: CEREC Software 5 supports you with artificial intelligence that enables improved initial proposals, and the ultimate custom chairside restorations for each individual patient. This saves time and lets you move to production faster. You will benefit from the simple, clearly structured and visually appealing user interface that is operated via touchscreen or touch pad.

Quick and easy

It only takes 5 clicks to create a finished restoration. The optimized user interface features a well-structured menu and is easy to operate. The clearly arranged dialog windows allow for quick navigation and the software automatically skips any unnecessary steps in the workflow.

Intelligent and individual

The new software generation, CEREC 5, makes use of artificial intelligence to calculate better-than-ever initial proposals. It also automatically recognizes the indication of the restoration, based on the scan. The artificial intelligence component optimally calculates the model axis, preparation margins and initial restorative proposals. With all this, you can fully focus on your patient.

Flexible and networked

The export and import function of restoration data as a DXD file creates a seamless connection with the inLab software of your lab. The direct upload of scan and model data from the CEREC software to the Connect Case Center makes collaborating with the lab much less time-consuming. The export of scan data as open STL files allows for versatile workflows and indications.



"In most cases, the initial proposal of the CEREC software is so good that I can move straight to production without any further modifications."

Dr. Peter Schneider
Heidelberg, Germany



reddot design award
winner 2019

CEREC SW 5 6695592

- CEREC SW 5 USB stick
- CEREC SW 5 license without license stick
- Open Scan Export license included
- CEREC SW 5 can only be installed on a new AC with Primescan or Omnicam

CEREC Pro Module 6695626

- SICAT IMPLANT license included.
- The Pro module requires a CEREC SW 5 license and activates additional indications in the CEREC SW. No additional software needs to be installed.

Connect Case Center Inbox 6708171

- To upload data from the Connect Case Center portal. The laboratory must be registered with the Connect Case Center portal.

CEREC Ortho SW 2.0 6727049

- CEREC Ortho SW supports intraoral scanning for orthodontic analysis and treatment. The process allows the jaw to be scanned quickly and many export options are available.

dentsplysirona.com/cerecssoftware



CEREC / CEREC MILLING AND GRINDING UNITS

CEREC Primemill

Excellence made easy

The new grinding and milling unit utilizes state-of-the-art technology and CAM strategies to produce outstanding chairside restorations easier, faster and more precisely than before. A modern setup for achieving predictable results with an outstanding chairside experience – for both the user and patient.

CEREC takes another big step forward with the introduction of CEREC Primemill empowering dentists to provide and experience superior chairside dentistry.

Prime chairside experience

CEREC takes another big step forward with the introduction of CEREC Primemill empowering dentists to provide and experience superior chairside dentistry.



Powerful Touch Interface

The new 7" touch interface is highly intuitive and user-friendly, making operation easy.



Super Fast Mode for Zirconia Crowns

The unique parallel milling maximizes speed, delivering an excellent Zirconia crown in around 5 minutes.



New Electronics and Mechanical Components

Improved high edge-stability of the margins and very accurate material removal for smoothest surfaces.



Block Scanner

The block scanner quickly scans compatible data matrix codes on blocks, speeding up the workflow.



RFID Reader

Type and status of tools is recorded, ensuring failsafe workflows and increased productivity.



New 0,5mm Tool

New extra fine bur for producing highly detailed fissures as well as inter-dental areas on bridges.



CEREC Primemill

6617570

The following accessories are included with every CEREC Primemill delivery:

- CEREC Primemill basic unit
- Water tank (in unit) with filter insert
- Adapter sleeve
- Removal tool for adapter sleeve
- Calibration set
- Torque wrench
- Torque wrench HT
- Pressure screws, 3x
- Diamond CS starter set
- Bur CS starter set
- Technical documentation
- Power cable
- Crossover cable (LAN) 10 m
- Block clamp tool
- Dentatec 1000 ml
- Water tank filter, separately packed
- Tank lid opener
- Cleaning set
- Sieve insert
- O-rings, 3x
- Celtra Duo starter set (Germany only)

The following devices and components can be ordered separately:

- Suction device, 230 V or 120 V, with power cable
- Cleaning hose set
- inLab PC with power cable
- LAN switch
- LAN cable, 2 m
- USB license drive
- Monitor with power cable



CEREC Primemill

- 7" Touch Interface
- Super fast mode for Zirconia crowns
- Block scanner and RFID reader for an easier and faster workflow
- Complete range for a huge variety of indications up to 70 mm block size
- Smoother Zirconia restoration surfaces



CEREC MC XL Premium Package

- Complete range for lab indications up to 85 mm block size
- Precise and fast
- Production of CEREC Guide 2 and CEREC Guide 3 surgical guides
- Optional "extra fine" grinding



CEREC MC X

- Complete range of chairside applications up to 40 mm block size, including bridges and abutments
- Precise and fast
- Production of CEREC Guide 2 and CEREC Guide 3 surgical guides

Performance specifications	CEREC Primemill	CEREC MC XL Premium Package	CEREC MC X
High Speed Double Spindle 4-Axis Technology	4 Motors	4 Motors	2 Motors
Wet & Dry	■	■	■
Milling & Grinding	■	■	■
Wide Range of Materials	■*	■	■
Block Sizes	15,5 x 19 x 70 mm	15,5 x 19 x 85 mm	15,5 x 19 x 40 mm
Single-tooth restorations	■	■	■
Bridges	■**	■	■
Abutments	■	■	■
Surgical guides	■**	■	■
Extra fine grinding	■***	■	-
Extra fine milling with 0,5 mm tool	■	-	-
Smart Touch Interface	■	-	-
RFID reader	■	-	-
Block scanner	■	-	-
Block pre touch	■	-	-
Super fast Zirconia Milling	■	-	-
LED Light strip	■	-	-



CEREC / SINTERING AND GLAZING

CEREC SpeedFire

Full contour zirconia restorations in one session

CEREC SpeedFire is the smallest and fastest sintering furnace on the market and can typically sinter a crown in 10 to 15 minutes. This user-friendly device means that the advantages of full-contour zirconia can thus also be used for chairside treatment. If required, a glaze can be applied with the CEREC SpeedGlaze that can be fired in just a few minutes in the CEREC SpeedFire. Besides CEREC Zirconia, CEREC SpeedFire can process partner materials, such as IPS e.max® CAD (Ivoclar Vivadent) or Suprinity® PC (VITA® Zahnfabrik).

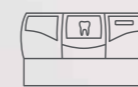

Orders sent automatically

The CEREC software sends the order with all the necessary information to the furnace.



Induction technology

allows unparalleled short sintering and firing times.



Just 10-15 minutes

is typically required for sintering a full-contour zirconia crown.



"CEREC SpeedFire is the only dental furnace you need. It can sinter, glaze and crystallise all your materials."

CEREC SpeedFire

6482520

Consisting of:

- High-temperature sintering furnace
- Positioning pin for door insulation
- Bottom door insulation
- Top door insulation
- CEREC SpeedPaste
- CEREC Zirconia Shade Guide
- Glazing Support Single Unit +A
- Glazing Support Multi Unit
- Tweezers
- LAN cable
- Ferrite core



CEREC / MATERIAL

The integrated CEREC practice

Single-visit restorations

Imagine being able to offer your patients restorations in a single visit - with all commonly used materials. CEREC makes it happen. Regardless of the material, CEREC offers your patients fast and comfortable treatment without uncomfortable impression trays or annoying temporary restorations, with just a single injection of anesthesia. It's a win-win situation: You will meet the highest expectations, and your patients receive the best possible treatment.

- Highly aesthetic restorations in a single visit
- Maximum automation and excellent initial proposals, thanks to artificial intelligence
- Easy and intuitive software with touchscreen and gesture control
- Large variety of materials for both anterior and posterior solutions

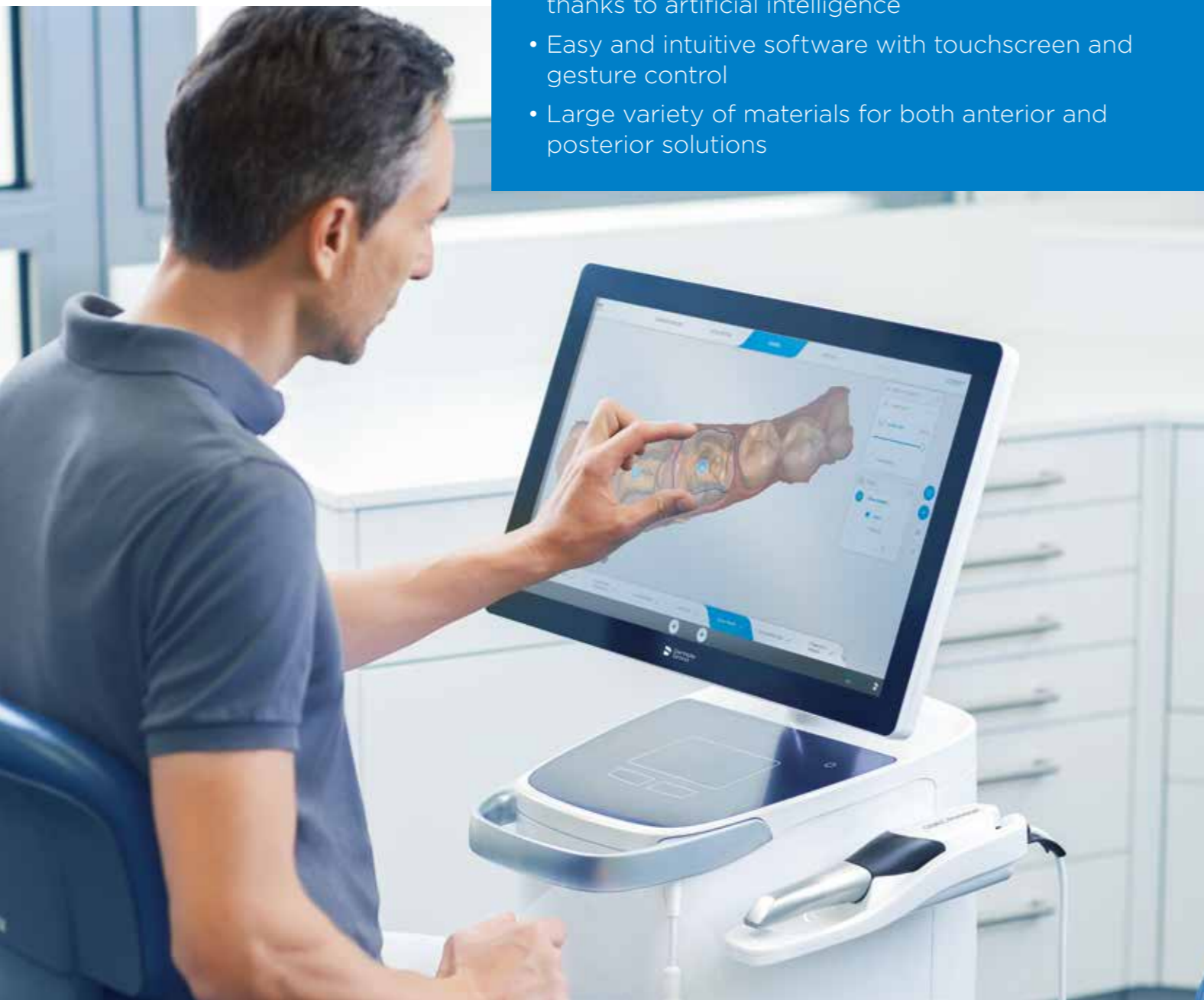

1 Digital impression

Spare your patients the discomfort of conventional impression. Take digital impressions with CEREC Primescan or CEREC Omnicam, our two powder-free intraoral scanners. They make scanning easier, more intuitive and ergonomic than ever before. The precise 3D models in natural colors will impress both you and your patients.



2 Design

The CEREC software creates outstanding design proposals, based on the unique Biojaw algorithm. Automatically reconstruct genuine tooth restorations that are customized for each individual patient. This saves time since the initial proposal is so accurate that you can generate the final design of your restoration in no time at all. You benefit from the simple, clearly structured and intuitive user interface.



3 Grinding or milling

The CEREC grinding and milling units and the CEREC software by Dentsply Sirona are completely synchronized. The grinding or milling process for your designed restorations is extremely precise and creates smooth surfaces and margins, as well as ultrafine structures. The large variety of materials is optimally coordinated with the Dentsply Sirona software and production units. Even zirconia can be processed and placed in a single visit.



4 Sintering and finishing

All-ceramic zirconium oxide restorations can be sintered and glazed in the CEREC SpeedFire furnace right in your practice. The induction technology of the furnace offers the shortest firing times, together with highly intuitive and simple operation. In addition to zirconium oxide, all other glass ceramics can be processed.



CEREC / SOLUTIONS

CEREC Chairside Implantology

Place implants safely and precisely -
in just a single visit

CEREC is also an integral part of the safe and individualized chairside implantology solution from Dentsply Sirona. That means CEREC not only enables you to create customized implant prosthetics, but also helps you plan the surgery and insert the implant.

CEREC is compatible with many different implant systems and enables the manufacture of individually designed abutments and crowns for cemented and screw-retained restorations, made from a variety of materials of the highest quality. Thanks to CEREC Zirconia meso, you can now also quickly complete the implant with a screw-retained crown on Dentsply Sirona TiBases. This solution is particularly gentle on the gingival tissue due to its extremely high biocompatibility and extraoral bonding.



1 Data capture

During the first step, all scans that are necessary for planning are performed: intraoral impression for information about the soft tissue and to create a prosthetic proposal, as well as 3D x-rays. Both sets of data are needed for precise, prosthetic-oriented implant planning.

With the help of CEREC Primescan or CEREC Omnicam, digital impressions of freshly placed implants can be taken immediately. The implant prosthetic is then designed in the CEREC software in a few steps, finalized with a suitable grinding and milling unit and sintered with the CEREC SpeedFire, the smallest and fastest furnace. For more about prosthetics steps, please refer to pages 18 and 19. For planning the surgical guides you will need the CEREC Pro module. This module includes all necessary interface licenses.

dentsplysirona.com//cerec-implantology - Chairside implantology with CEREC

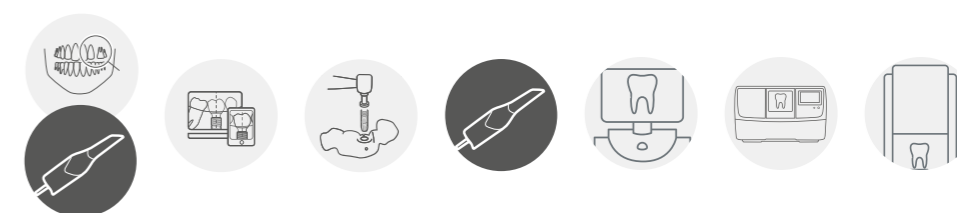

- Optimized clinical success and safety thanks to prosthetics-oriented implant planning and fully guided surgery
- Individual prosthetics with patient-specific abutment and crown or screw-retained crown
- Fewer treatment sessions thanks to the option of completing the implant directly after the surgical procedure



2 Implant planning

The data sets are aligned in the Galileos Implant software. They allow implant planning and cost-efficient manufacturing of the surgical guide, in less than one hour with the help of a suitable CEREC grinding and milling unit.



3 Guided surgery

Due to the precise transfer of the implant planning, the implant can be safely placed with CEREC Guide 3. Use CEREC Guide 3 for all Dentsply Sirona implant systems, or CEREC Guide 2 for implants by other manufacturers.



4 Scanning



5 Designing



6 Grinding/milling



7 Sintering/finishing



CEREC / SOLUTIONS

From the practice to the lab

Freedom of collaboration - secure data transmission

When you work with the lab of your choice, there are different workflows available to you. You can transfer data with the open STL format; however, the responsibility for the data transmission and the associated due diligence remains with you. If you prefer not to worry about any of this, make use of our validated processes. Transmit your data securely - in anonymized format, if desired - to your dental lab via the Connect Case Center: It only takes a single click. Regardless of the software your lab uses. The connection is established seamlessly to inLab or via the Connect Case Center Inbox to any other laboratory software (e.g. that of our new partner exocad).



New: Connect Case Center Inbox

Good news for your lab. In the past, only inLab users were able to receive cases via the secure Connect Case Center. With the Connect Case Center Inbox, your lab can now use its usual software and still have full access to the patient case. And best of all: Whether CEREC Primescan or CEREC Omnicam - each device comes with a free license that you can make available to your lab.

- Fast and accurate scans
- Digital ordering for work of all kinds
- Easy and convenient data transfer via the Connect Case Center
- Open STL export available

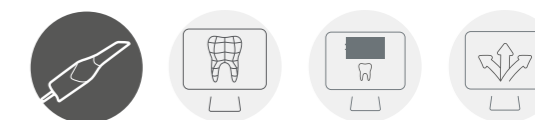

1 Scanning

Both CEREC Primescan and CEREC Omnicam can quickly and accurately generate an impression of the preparation, the antagonist and the bite in the patient's mouth - powder-free and in color. You can interrupt and resume the scan procedure at any time. Digital impression models have the advantage that you can assess quality right there on the screen.

2 Data transmission via the Connect Case Center

With a single click in the software, the case is transmitted to the lab of your choice without fail. In addition to secure and anonymized transmission, if desired, you and your lab also have a high level of documentation. You can even use the Connect Case Center for a case-specific chat. All agreements with your dental lab will be documented. All of these processes are much faster than with traditional impressions. You can even respond to questions from your lab while your patient is still in the chair.

3 Data reception by the lab of your choice

Upload the 3D model to the Connect Case Center and complete the digital order form - in a matter of seconds. Third parties will not be able to access the transmitted case data. By installing Connect Case Center Inbox, labs without inLab software can also be easily connected to the Connect Case Center. Thanks to the digital technology, your lab can now exchange images with you and discuss details in real time. Your collaboration will become closer than ever before.

dentsplysirona.com/clinictolab - Benefits of Connect Case Center at a glance.



CEREC / SOLUTIONS

From the practice to specialized partners

Guided implantology and patient-specific prosthetics from industry leaders

Connect Case Center offers a comprehensive solution for collaborating with established partners. If you need help with any workflow steps, simply access our centralized functions and take advantage of our knowledge and experience. This solution saves time, and you don't have to invest into additional software or equipment.

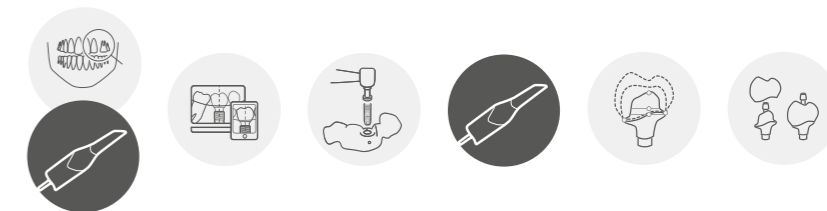

- Rely on the safe, seamless workflows of guided implantology for greater patient comfort and best results
- Simplant®* offers dentists the right surgical guide for each individual case to achieve precise and predictable implant treatments.
- Atlantis®* is our solution for the manufacturing of patient-specific prosthetics for all common implants.



1 Data Capturing

See more with a CBCT image that visualizes and gives information about the patient's anatomical situation. With the intraoral scanners CEREC Omnicam and CEREC Primescan, you can capture the patient's dentition and surrounding soft tissues. The combination of bone situation and soft tissue information are the optimal basis for ideal restorative and implant planning.



2 Restorative and Implant planning

mySimplant planning service is the outsourced way to receive a plan of the implant surgery without the need to purchase a planning software. CBCT data, intraoral scan data and clinician-made case specifications are sent to Dentsply Sirona to prepare a Simplant treatment plan. When the planning proposal has been designed, it is sent back to the dentist for validation and approval.



3 Guided surgery

When the Simplant treatment plan has been approved, the Simplant Guide is produced by Dentsply Sirona using a state-of-the-art manufacturing process to ensure the highest precision and quality each and every time. Using a surgical guide ensures precise implant placement and sets the path for safe and accurate treatment. Together with the surgery kit, guided surgery drills and the Simplant Guide, the implant can be placed according to the treatment plan.

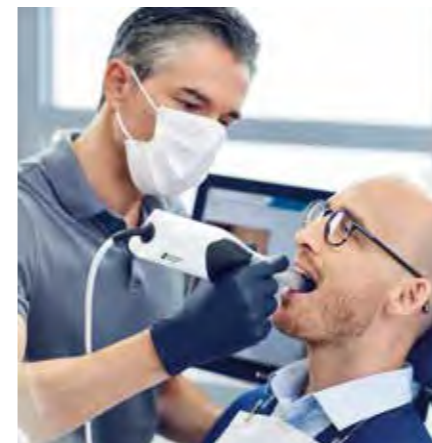

4 Digital Impression

Right after the implant is placed within the surgery, take an accurate digital impression in natural colours. It couldn't be easier. With the small, easy-to-handle Primescan or Omnicam, impression taking is more pleasant and time-saving than ever before.



5 Restorative design and manufacturing

The order is initiated by the dentist directly in Connect Case Center and sent to Dentsply Sirona central production for Atlantis solutions. A design proposal is sent to the dentist and dental technician to review, discuss and approve. Atlantis abutments, crowns or digital files are available for both cement and screw-retained restorations. The crown can also be finalized using Atlantis Core File and inLab software.



6 Final restoration

Atlantis abutments and crowns are produced by Dentsply Sirona using a state-of-the-art milling process. The design of Atlantis patient-specific solutions is based on the anatomy and clinical situation of each patient, truly mimicking natural tooth function and appearance. The crown can also be milled using an inLab machine and sintered using inFire HTC speed.

dentsplysirona.com/clinictopartner



CEREC / INTRAORAL SOFTWARE

Digital Intraoral Monitoring

Visualize intraoral changes over time with Oracheck

Make the best of your intraoral scanner and visualize volumetric changes in the soft tissue, hard tissue and the position of the teeth over time. OraCheck provides a 3D comparison between two or more digital scans. The software superimposes the scans and visualizes differences in color. With OraCheck, an intraoral scan becomes a standard procedure in the dental office, because it supports the clinician to see and monitor the individual patient situation.

Main features of the OraCheck Software



Volume measurement

Calculation of the volumetric change (increase/loss) in mm^3 .



2D cross section

Presentation and measurement of distances in any cross-sections that can be interactively defined.

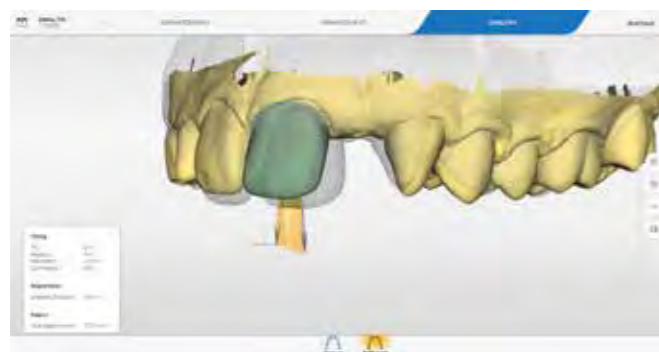

Tooth movements

Calculation and visualization of tooth movements.



Distance analysis

Visualize the distance between two scans.



HUB / DATA BACKUP SOLUTION

Playing it safe with Hub

Streamlined workflows and complete data security for your practice technology

If you plan to run more than one acquisition unit Hub is ideal for you: Hub keeps data available across all devices so there is no need to recreate patient data or transfer cases from one device to another.

When it comes to case storage, duplicate copies provide protection against data loss. Hub data storage and transmission are encrypted so securely that even our technicians cannot access your data from outside your office. Hub has no vulnerabilities to make it susceptible to theft or misuse, ensuring that your patients' personal privacy remains protected.

- Plug & Play installation
- Secure local backup
- Consistent data throughout your practice



dentsplysirona.com/hub

CEREC Hub
6637362

THE DENTAL
SOLUTIONS
COMPANY™

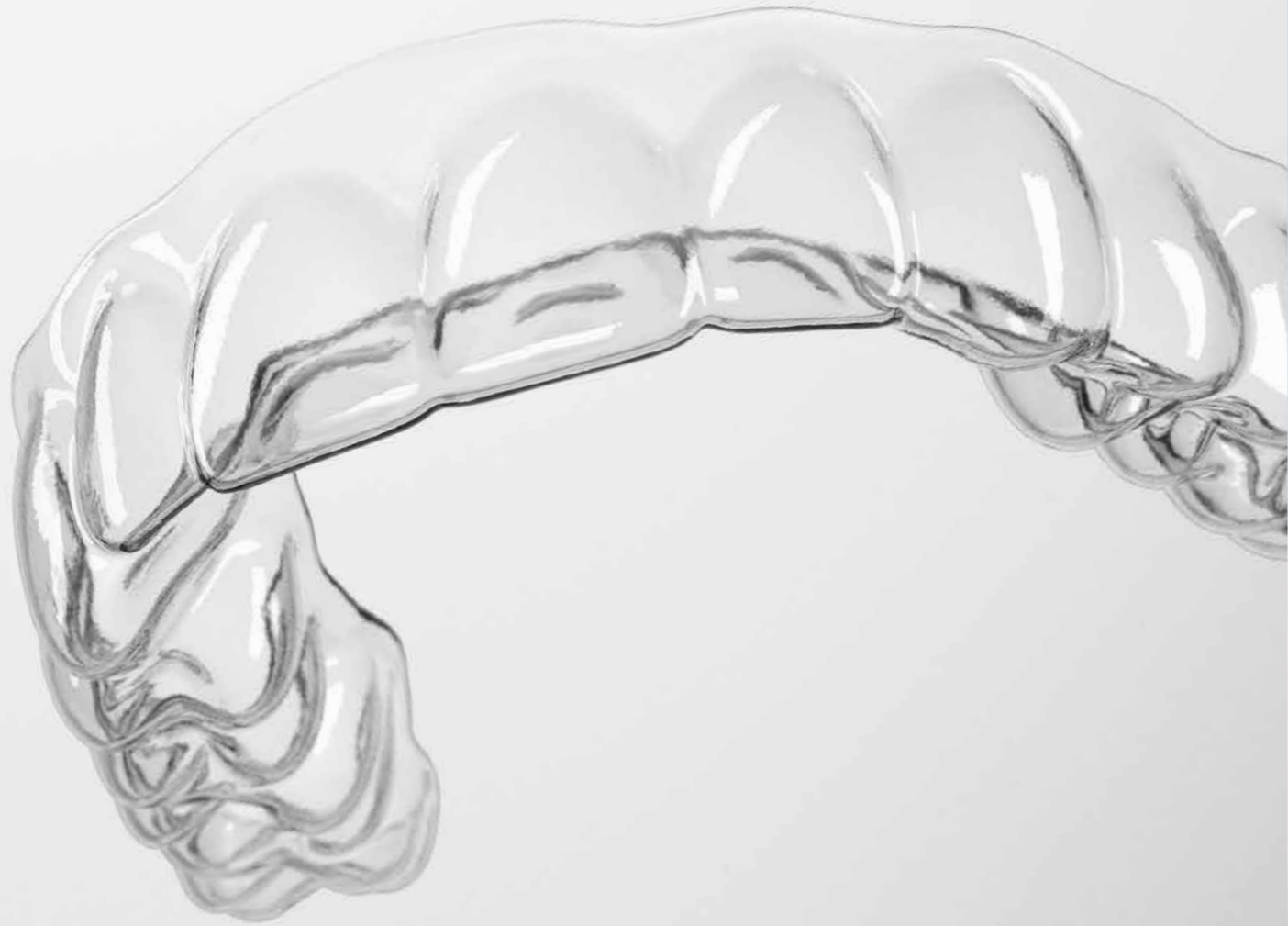

SureSmile®

Made with our expertise
for your perfect results

Coming soon
to the MENA
region

Inspired by an orthodontic pioneer spirit and driven by the 20-year experience of the SureSmile digital lab, we developed the easy-to-use SureSmile Aligner solution for outstanding initial setups, minimal refinements, and long-lasting results. Here to make your daily routines even more excellent.

dentsplysirona.com/suresmile



Proven CAD/CAM Consumables from Dentsply Sirona

All-ceramic restorations fabricated on Dentsply Sirona's CAD/CAM systems have proved themselves millions of times in clinical practice. To fulfill the highest standards in terms of quality and machinability we are continuously developing high-performance materials and accessories which are tailored to our design software and our milling and grinding units.

The Dentsply Sirona CAD/CAM consumables portfolio eliminates the trade-off between efficiency and aesthetics, with simpler to use CAD/CAM materials that produce high-quality outcomes at a pace and workflow that keeps your business successful.





Burs

Burs	269
------	-----

Blocs and Discs

Feldspar Ceramics	
CEREC Blocs C and CEREC Blocs PC	272
Zirconia-Reinforced Lithium Silicate (ZLS)	
Celtra® Duo	275
Zirconia Oxide	
CEREC Zirconia	279
CEREC Zirconia meso, inCoris ZI meso	280
inCoris ZI	281
inCoris TZI	282

Implant-Supported Restorations

TiBase	284
Abutment Screws	285
ScanPost	286
Scanbody	287
inPost	287

Accessories

Equipment Consumables	288
-----------------------	-----



BURS

Burs

Optimally developed cutting geometries and coatings for various indications and materials

CAD/CAM milling instruments are the machine parts, known as burs, which do the actual milling of the composite blocks in their respective units. Replacing milling burs, lubricant and filters on a regular maintenance schedule increases the efficiency and longevity of the CAD/CAM machine.

Special burs

Shaper and finisher burs

Special burs have been developed for the milling of models on the inLab MC XL unit: A shaper with a diameter of 2.5mm (Shaper 25) and a finisher with a diameter of 1.0mm (Finisher 10).

- Designed for milling of CEREC connect models, Zirconia, resins and temporary materials
- Do not use carbides for milling of ceramic materials
- Use of these burs can require a motor upgrade and starter kit

Extra Fine (EF) Burs

Extra Fine (EF) burs allow users an additional grinding option for their 4-motor milling unit.

Good to Know

Milling vs. grinding

What is the difference between milling and grinding?

Grinding is using diamond burs, usually on a fully or semi-crystallised material. So if you are using the Step Burs 12, 12S or 20, please choose grinding in your admin phase. Grinding is always done with water and is known as wet 'milling'.

Milling uses Tungsten Carbide burs on softer materials like acrylic (temporary materials and CEREC guide blocks) or Zirconia. When using a Shaper 25 RZ, Shaper 25 and Finisher 10, please choose milling in your admin phase.

Ensure the Milling option is active in the software

Use the following steps to verify:

- Click the golden arrow in the upper left corner of the software screen to access the system menu
- Click Configuration
- Click Settings
- Click MC XL Milling
- Click Activate

Important notice

Milling is not possible on all CEREC and inLab units. Only newer models are dry milling enabled as a vacuum unit is required. However certain milling units are upgradable. Please contact Dentsply Sirona and have the serial number of your milling unit ready to discuss upgrade options.



Wet milling



Dry milling

Burs for CEREC MC, MC X and MC XL and inLab MC XL

Item Number	Description	Contents	Side	Compatible Milling Units
6240159	Cylinder Pointed Bur 12S	12mm long - 6 per box	Right	CEREC MC, CEREC MC X, CEREC MC XL (Premium Package), inLab MC XL
6260025	Step Bur 12	12mm long, 1mm diameter - 6 per box	Left	
6240167	Step Bur 12S	12mm long, 1.3mm diameter - 6 per box	Left	
6259597	Step Bur 20	20mm long - 6 per box	Left	
6259589	Cylinder Pointed Bur 20	20mm long - 6 per box	Right	
6299387	Finisher 10	Tungsten Carbide, 1mm diameter - 3 per box	Left and Right	
6433440	Shaper 25 RZ	Tungsten Carbide, 2.5mm diameter - 3 per box	Left and Right	
6299395	Shaper 25	Tungsten Carbide, 2.5mm diameter - 3 per box	Left and Right	
6479856	HT Torque Wrench	For Finisher and Shaper Burs - 1 per box	N/A	
6434570	HT Torque Wrench	For Finisher and Shaper Burs - 1 per box	N/A	
6535186	Cylinder Bur 12 (EF)	12mm long - 6 per box	Left	
6535178	Cylinder Pointed Bur 12 (EF)	12mm long - 6 per box	Right	

Burs for CEREC 3 and inLab Compact Milling Units

Item Number	Description	Contents	Application
6089010	Step Bur 10	10mm long - 6 per box	N/A
6052265	Step Bur 12	12mm long - 6 per box	N/A
6089028	Step Bur 14	14mm long - 6 per box	Machining of VITA® CAD-Wax
5885103	Cone Bur 10	10mm long - 6 per box	N/A
5935668	Cone Bur 12	12mm long - 6 per box	Machining of VITA® CAD-Wax
5999771	Cone Bur 14	14mm long - 6 per box	Machining of VITA® CAD-Wax
5855734	Cylinder Pointed Bur	10mm long, 1.6 diameter - 6 per box	N/A

Burs for inLab MC X5 (5 Axis Laboratory Milling Unit)

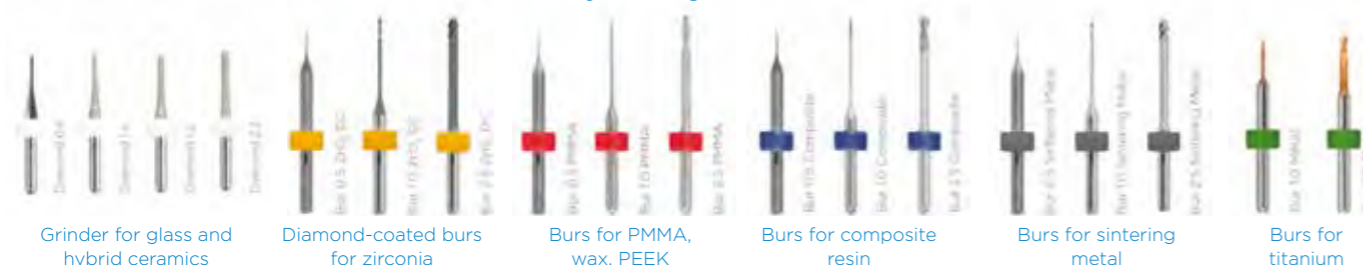

Item Number	Description	Description
6478007	Diamond 2.2 for Glass Ceramics	1 per box
6478015	Diamond 1.4 for Glass Ceramics	1 per box
6478023	Diamond 1.2 for Glass Ceramics	1 per box
6542232	Diamond 0.6	1 per box
6478031	Bur 2.5 ZrO2	1 per box
6478049	Bur 1.0 ZrO2	1 per box
6478056	Bur 0.5 ZrO2	1 per box
6478098	Bur 2.5 PMMA	1 per box
6478106	Bur 1.0 PMMA	1 per box
6478114	Bur 0.5 PMMA	1 per box
6572932	Bur 2.5 ZrO2 DC (Diamond Coated)	1 per box
6572940	Bur 1.0 ZrO2 DC (Diamond Coated)	1 per box
6572957	Bur 0.5 ZrO2 DC (Diamond Coated)	1 per box
6478155	Bur 2.5 Composite	1 per box
6478163	Bur 1.0 Composite	1 per box
6478171	Bur 0.5 Composite	1 per box
6478064	Bur 2.5 Pre-Sintered Metal (inCoris CC)	1 per box
6478072	Bur 1.0 Pre-Sintered Metal (inCoris CC)	1 per box
6478080	Bur 0.5 Pre-Sintered Metal (inCoris CC)	1 per box
6606243	Bur 2.0 Metal Cutter for Titanium Abutments	1 per box
6606292	Bur 1.0 Metal Cutter for Titanium Abutments	1 per box

Depending on whether it is for wet or dry processing, different tools are used. The cutting geometries and coatings of the diamond grinders and carbide cutters have been optimised for different indications and materials and provide for outstanding surface results and margins. The coated zirconia milling cutters have a significantly longer service life compared to uncoated cutters and achieve smoother surfaces.

¹ Not a registered trademark of Dentsply Sirona.



CEREC Primemill Excellence made easy.

The new CEREC Primemill is uniquely equipped for superior chairside dentistry. Our fastest milling unit ever, it's also the easiest to use and compatible with the widest range of materials. Above all, it empowers dentists to deliver consistently excellent treatment for multiple indications.

The CEREC Primemill seamlessly combines with the highly accurate CEREC Primescan and new CEREC Software 5 to redefine performance in daily practice. Join us at your local CEREC event and test it yourself.

The all-new CEREC. **Now is the time.**

Learn more at: dentsplysirona.com/cerecprimemill

THE DENTAL
SOLUTIONS
COMPANY™





BLOCKS / FELDSPAR CERAMICS

CEREC Blocs C and CEREC Blocs C PC

Single and multi-colour feldspar ceramics

The CEREC Blocs C and CEREC Blocs C PC are made of industrially produced fine-structured feldspar ceramic. This means that the restorations are easy to polish and display outstanding enamel-like abrasion properties. Feldspar ceramics offer convincing benefits in terms of longevity and machinability. This has been demonstrated in numerous scientific studies, and to date, more than a million restorations have been created out of the feldspar ceramic blocks.

The CEREC Blocs C and CEREC Blocs C PC can be used to produce inlays, onlays, crowns and veneers with CEREC chairside or inLab. CEREC and inLab users will benefit from the sophisticated CEREC shade selection system covering the classic VITA® shades, providing the basis for creating highly aesthetic restorations that require only a minimum milling effort.

Good to know

Physical data:

CTE: approx. $9.4 \times 10^{-6} \text{K}^{-1}$ (20-500 °C)

Flexural strength:

Intrinsic on delivery: 154 MPa
After processing/polishing: 113 MPa
Vickers hardness: approx. 640 HV

'C' stands for classic colours (A1-D4) + BL2



CEREC Blocs C

Enamel-like-properties for inlays, onlays, veneers and fully anatomical crowns

CEREC Blocs C are monochromatic blocks (single colour) and are optimised for use for inlays, partial crowns, and veneers. CEREC Blocs C guarantee a very good colour integration into the residual tooth tissue of restorations and also have a clinical survival rate of 90% after 10 years.



Item Number	Description	Block Size	Contents
6484542	CEREC Blocs C Bleach 2C	10mm	8 per box
6484427	CEREC Blocs C A1	10mm	8 per box
6484435	CEREC Blocs C A2	10mm	8 per box
6484443	CEREC Blocs C A3	10mm	8 per box
6484450	CEREC Blocs C A3.5	10mm	8 per box
6484591	CEREC Blocs C A4	10mm	8 per box
6484617	CEREC Blocs C B2	10mm	8 per box
6484625	CEREC Blocs C B3	10mm	8 per box
6484633	CEREC Blocs C C2	10mm	8 per box
6484641	CEREC Blocs C C3	10mm	8 per box
6484658	CEREC Blocs C D3	10mm	8 per box
6484666	CEREC Blocs C Bleach 2C	12mm	8 per box
6484468	CEREC Blocs C A1	12mm	8 per box
6484476	CEREC Blocs C A2	12mm	8 per box
6484484	CEREC Blocs C A3	12mm	8 per box
6484492	CEREC Blocs C A3.5	12mm	8 per box
6484716	CEREC Blocs C A4	12mm	8 per box
6484724	CEREC Blocs C B2	12mm	8 per box
6484732	CEREC Blocs C B3	12mm	8 per box
6484740	CEREC Blocs C C2	12mm	8 per box
6484757	CEREC Blocs C C3	12mm	8 per box
6484765	CEREC Blocs C D3	12mm	8 per box
6484773	CEREC Blocs C Bleach 2C	14mm	8 per box
6484500	CEREC Blocs C A1	14mm	8 per box
6484518	CEREC Blocs C A2	14mm	8 per box
6484526	CEREC Blocs C A3	14mm	8 per box
6484534	CEREC Blocs C A3.5	14mm	8 per box
6484781	CEREC Blocs C A4	14mm	8 per box
6484831	CEREC Blocs C B2	14mm	8 per box
6484849	CEREC Blocs C B3	14mm	8 per box
6484856	CEREC Blocs C C2	14mm	8 per box
6484864	CEREC Blocs C C3	14mm	8 per box
6484872	CEREC Blocs C D3	14mm	8 per box

CEREC Blocs C PC

Polychromatic for natural-looking anterior and posterior crowns

CEREC Blocs C PC are polychromatic blocks (multi-colour) and are optimised for the use in crowns. With their three different layers based on varying degrees of colour saturation (chroma), they can be optimally adapted to characteristic colour gradients in restorations with respect to translucency and intensity in the classical VITA® colours A1-A3.5.



Item Number	Description	Block Size	Contents
6484559	CEREC Blocs C PC A1	12mm	8 per box
6484567	CEREC Blocs C PC A2	12mm	8 per box
6484575	CEREC Blocs C PC A3	12mm	8 per box
6484583	CEREC Blocs C PC A3.5	12mm	8 per box
6484674	CEREC Blocs C PC A1	14mm	8 per box
6484682	CEREC Blocs C PC A2	14mm	8 per box
6484690	CEREC Blocs C PC A3	14mm	8 per box
6484708	CEREC Blocs C PC A3.5	14mm	8 per box
6484799	CEREC Blocs C PC A1	14mm x 14mm	8 per box
6484807	CEREC Blocs C PC A2	14mm x 14mm	8 per box
6484815	CEREC Blocs C PC A3	14mm x 14mm	8 per box
6484823	CEREC Blocs C PC A3.5	14mm x 14mm	8 per box

Other:

6484906 CEREC Blocs Sample Package C 45

6484948 CEREC Blocs Shade Guide C
The Shade Guide for CEREC Blocs C and CEREC Blocs C PC contains 11 different colour sample plates made of original feldspar ceramics in VITA® classical colours A1-D3 and Bleach 2. The 1.5mm colour sample plates corresponds approximately to the thickness of a restoration for a quick and reliable shade taking.



¹ Not a registered trademark of Dentsply Sirona.



BLOCKS / ZIRCONIA-REINFORCED LITHIUM SILICATE (ZLS)

Celtra® Duo: Zirconia-Reinforced Lithium-Silicate (ZLS)

Developed to make a difference

Celtra® Duo is a CAD/CAM block for chairside use with the CEREC unit. It contains a new high strength glass ceramic made from Zirconia-Reinforced Lithium-Silicate (ZLS) which provides high flexural strength, state-of-the-art aesthetics through its opalescence and translucency, and easy handling.

Celtra® Duo transfers these features into clinical benefits by offering the choice of two handling options: Mill and Polish (210MPa flexural strength) or Mill and Fire (370MPa flexural strength). Being one block with two options, Celtra® Duo combines the advantages of other CEREC blocks in one product.

Option 1: Mill and Polish (210 MPa flexural strength)

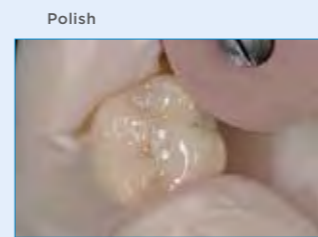

Option 2: Mill and Fire (370 MPa flexural strength)



Note that Option 2 allows even more processing flexibility:

Wet-firing technique
• Mill → Stain and glaze → Fire → Seat

Dry-firing technique
• Mill → Polish → Fire → Seat

The unique microstructure

The outstanding properties of ZLS are a function of its unique microstructure. The presence of 10% zirconia in the glass phase in atomically dissolved form, provides high strength and ensures safe and long-lasting restorations. The zirconia is essentially responsible for the nucleation of crystal phase. The result is a large number of very fine-grained lithium crystallites, whose high glass content give the material its excellent light-optical and mechanical properties. Translucency, opalescence, fluorescence and the chameleon effect all benefit, with high edge stability and excellent polishability being an added plus. This ultra-fine microstructure allows Celtra® Duo to be processed quickly and efficiently in its crystalline state and in the appropriate tooth shade.

Microstructure comparison

ZLS
Glass with completely dissolved zirconia

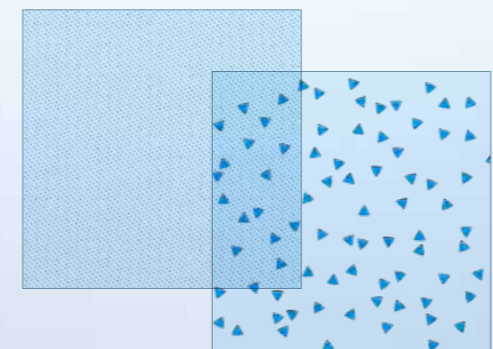

Lithium silicate crystallites
500-700nm

LS₂
Glass

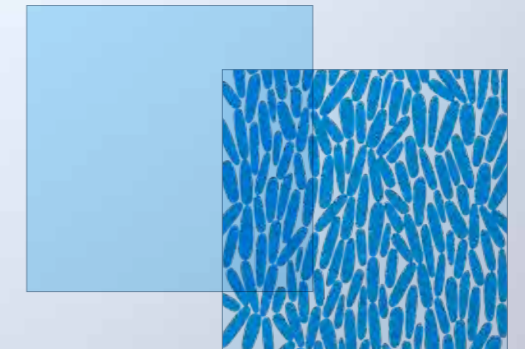

Lithium disilicate crystallites
2000-4000nm



Celtra® Duo Starter Kit

- 5365490113 1 Kit Contains:
- 19x Blocks,
 - 1x 5g Glaze,
 - 1x Brush,
 - 1x Fixing Pad,
 - 1x Set of Fixing Pins



Good to know

Physical data:

- CTE: approx. 11.8 x 10K (25-500°C)
- Modulus of elasticity: approx. 70,000 N/mm
- Vickers hardness: approx. 700 HV
- Fracture toughness: 2.0 MPa √m
- Density: 2.6 g/cm
- Chemical solubility: <40 µg/cm intrinsic, <20 µg/cm glaze
- Softening temperature: approx. 800 °C
- Transformation temperature: approx. 620 °C

Flexural strength:

- Intrinsic on delivery: 420 N/mm
- After processing/polishing: 210 N/mm
- After glaze firing: 370 N/mm

DO NOT:

- Do not use CEREC SpeedPaste (or Object Fix) in processing Celtra® Duo. The Celtra® Duo restoration should be placed on the firing pad for processing in the furnace
- Do not use CEREC SpeedGlaze with Celtra® Duo. Dentsply Sirona has its own Stain and Glaze Kit (see next page) that should be used

Celtra® Duo Low Translucency (LT) blocks

Item Number	Description	Block Size	Contents
5365411005	Celtra® Duo, LT A1	14mm	4 per box
5365411015	Celtra® Duo, LT A2	14mm	4 per box
5365411025	Celtra® Duo, LT A3	14mm	4 per box
5365411035	Celtra® Duo, LT A3.5	14mm	4 per box
5365411055	Celtra® Duo, LT B1	14mm	4 per box
5365411065	Celtra® Duo, LT B2	14mm	4 per box
5365411095	Celtra® Duo, LT C1	14mm	4 per box
5365411105	Celtra® Duo, LT C2	14mm	4 per box
5365411135	Celtra® Duo, LT D2	14mm	4 per box
5365411145	Celtra® Duo, LT D3	14mm	4 per box
5365411175	Celtra® Duo, LT BL2	14mm	4 per box
5365411185	Celtra® Duo, LT BL3	14mm	4 per box

Celtra® Duo High Translucency (HT) blocks

Item Number	Description	Block Size	Contents
5365411205	Celtra® Duo, HT A1	14mm	4 per box
5365411215	Celtra® Duo, HT A2	14mm	4 per box
5365411225	Celtra® Duo, HT A3	14mm	4 per box
5365411255	Celtra® Duo, HT B1	14mm	4 per box
5365411375	Celtra® Duo, HT BL2	14mm	4 per box
5365411385	Celtra® Duo, HT BL3	14mm	4 per box
5365411295	Celtra® Duo, HT C1	14mm	4 per box
5365411305	Celtra® Duo, HT C2	14mm	4 per box
5365411335	Celtra® Duo, HT D2	14mm	4 per box
5365411345	Celtra® Duo, HT D3	14mm	4 per box

Other

- 601590 Celtra® Duo Shade Guide
- 5365901205 Celtra® Duo Firing Pads (3 per box)
- 5365901204 Celtra® Duo Firing Tray Pins (5 per box)
- 5365490112 TwisTec-Set (9 per box)
- 430491 Etchant Gel and Neutraliser

Try me with...

Prime&Bond universal™ and Calibra® Ceram

Calibra® Ceram cement is formulated to ensure strong bonds and long-term success in all-ceramics and CAD/CAM restorations. When combined with the high strength and low film thickness of Prime&Bond universal™ adhesive, they become the ideal cementation companions for Celtra® Duo (ZLS) restorations when used chairside with our CEREC CAD/CAM system.



Dentsply Sirona Universal Stain & Glaze Kit

- 600700 Dentsply Sirona Universal Stain & Glaze Kit
- 21x 5g Dentsply Sirona Universal Stain & Glaze
 - 5x 5g Body Stains: S0-S4
 - 2x 5g Incisal Stains: i1-i2
 - 14x 5g Colour Stains: White, Creme, Sunset, Copper, Khaki, Olive, Mahogany, Violet, Purple, Raspberry, Grey, Chestnut, Blue, Pink
 - 2x 5g Dentsply Sirona Universal Overglazes: Standard & High Flu
 - 1x 50ml Dentsply Sirona Universal Stain & Glaze Liquid
 - 1x MagicStain Brush
 - 1x Shade Guide: Stains Indicator
 - 1x Directions for Use
 - 1x Cercon® Staining Recipe Guide
 - 1x Celtra® Duo Staining Recipe Guide

Dentsply Sirona Shade Guide

- 601006 Dentsply Sirona Shade Guide - Stains Indicator



Dentsply Sirona Universal Glaze Refill

- (1x 5g Dentsply Sirona Universal Glaze in Jar)
- 605540 Overglaze
 - 605542 High-Flu

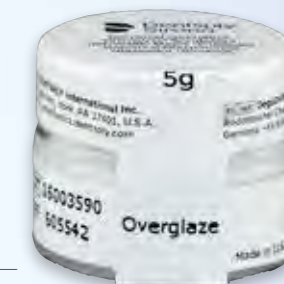

Dentsply Sirona Universal Stain and Glaze Liquid

- 601315 1x 15ml Bottle
- 601350 1x 50ml Bottle

Dentsply Sirona Universal Stain Refill

(1x 5g Dentsply Sirona Universal Stain in Jar)

- 605520 Body S0
- 605521 Body S1
- 605522 Body S2
- 605523 Body S3
- 605524 Body S4
- 605531 Incisal i2
- 605532 Incisal i2
- 605500 White
- 605501 Creme
- 605502 Sunset
- 605503 Copper
- 605504 Khaki
- 605505 Olive
- 605506 Mahogany
- 605507 Violet
- 605508 Raspberry
- 605509 Purple
- 605510 Grey
- 605511 Chestnut
- 605512 Blue
- 605513 Pink



Required milling instruments for Celtra® Duo blocks

Options	Left	Right
Grinding Option 1	Step Bur 12S	Cylinder Bur 12S
Grinding Option 2	Step Bur 12	Cylinder Bur 12S
Grinding Option 3	Cylinder Bur 12 (EF)	Cylinder Bur 12 (EF)

CEREC CAD/CAM solutions for optimised workflow and optimised outcomes... every step of the way

The entire family of CEREC product essentials from Dentsply Sirona was designed with workflow optimisation in mind, all in an effort to ensure better, safer and faster dentistry. Each component in the CEREC process was developed to complement, strengthen and enhance the working properties of one another. This streamlines your workflow, saves time and ultimately results in more consistent and predictable results.



Whether you choose to craft your CEREC restorations with Celtra® Duo (ZLS) or CEREC Zirconia, or even a combination of both materials, Dentsply Sirona offers a complete suite of restorative CAD/CAM essentials designed to ensure optimal outcomes from start to finish.



BLOCKS / ZIRCONIA OXIDE

CEREC Zirconia

Full-contour zirconium oxide for CEREC

Zirconia is a sought-after high-performance material that is linked with an optimally adapted workflow by CEREC. CEREC Zirconia is available in 2 block sizes. These translucent blocks are pre-coloured in VITA®1 classical shades, then processed in a partially sintered state, and densely sintered after milling. The aesthetic properties of CEREC Zirconia allow the blocks to be used as fully anatomical crowns and bridges.

Benefits at a glance:

- Zirconium oxide restoration in a single appointment with CEREC
- Minimal invasive preparation
- Precise edges and highly detailed occlusal surfaces
- High strength
- Corrosion resistance
- Good biological compatibility of the product
- Pre-shaded classic colours (A1-A4; B2; B3; C2; C3; D3)



CEREC Zirconia mono

Item Number	Description	Block Size	Contents
6576990	CEREC Zirconia mono L A1	20mm x 19mm	3 per box
6577006	CEREC Zirconia mono L A2	20mm x 19mm	3 per box
6577014	CEREC Zirconia mono L A3	20mm x 19mm	3 per box
6577022	CEREC Zirconia mono L A3.5	20mm x 19mm	3 per box
6577030	CEREC Zirconia mono L A4	20mm x 19mm	3 per box
6577048	CEREC Zirconia mono L B2	20mm x 19mm	3 per box
6577055	CEREC Zirconia mono L B3	20mm x 19mm	3 per box
6577063	CEREC Zirconia mono L C2	20mm x 19mm	3 per box
6577071	CEREC Zirconia mono L C3	20mm x 19mm	3 per box
6577089	CEREC Zirconia mono L D3	20mm x 19mm	3 per box

CEREC Zirconia medi

Item Number	Description	Block Size	Contents
6577097	CEREC Zirconia medi S A1	40mm x 19mm	3 per box
6577105	CEREC Zirconia medi S A2	40mm x 19mm	3 per box
6577113	CEREC Zirconia medi S A3	40mm x 19mm	3 per box
6577121	CEREC Zirconia medi S A3.5	40mm x 19mm	3 per box
6577139	CEREC Zirconia medi S A4	40mm x 19mm	3 per box
6577147	CEREC Zirconia medi S B2	40mm x 19mm	3 per box
6577154	CEREC Zirconia medi S B3	40mm x 19mm	3 per box
6577162	CEREC Zirconia medi S C2	40mm x 19mm	3 per box
6577170	CEREC Zirconia medi S C3	40mm x 19mm	3 per box
6577188	CEREC Zirconia medi S D3	40mm x 19mm	3 per box

Accessories

6580067 CEREC SpeedPaste
 CEREC SpeedPaste is a ceramic firing paste and is used to fix restorations to the firing tray. The paste is very easy to remove after firing, e.g., by compressed air. The restorations do not have to be sandblasted, scraped or steamed after the firing process. The very good consistency of the material means that the restorations can be fixed easily and quickly on the firing tray. CEREC SpeedPaste was developed for use in the CEREC SpeedFire for Dentsply Sirona CAD/CAM ceramics, but can also be used for other ceramic materials and in other furnaces.



6570142 CEREC SpeedGlaze
 CEREC SpeedGlaze is a spray for glazing fully anatomical ceramic restorations. The spray creates a glass powder layer on the sprayed surface which is then melted on in the firing process. The spray is optimised for the CEREC SpeedFire workflow, but can also be used for all other restorations made from Dentsply Sirona ceramic blocks with the CEREC.



6576305 CEREC Zirconia Shade Guide
 The CEREC Zirconia Shade Guide provides optimum support during precision shade matching. The shade tabs were prepared from original CEREC Zirconia material, sintered in the CEREC SpeedFire and glazed with CEREC SpeedGlaze.



Try me with...

Calibra® Universal

Calibra® Universal is simple and easy to use with CEREC Zirconia restorations. There's no need to prepare dentin or enamel with an etchant or bonding agent, simply apply Calibra® Universal to the restoration and its ready to seat.





BLOCKS / ZIRCONIA OXIDE

CEREC Zirconia meso

Customised zirconium oxide abutment crowns in a single appointment

CEREC Zirconia meso blocks facilitate the production of customised abutment crowns, adhesively connected to Dentsply Sirona TiBase. These pre-coloured blocks contain the same translucency as the other CEREC Zirconia blocks, and can be easily adapted for sintering with the CEREC SpeedFire along with the inFire HTC speed.

CEREC Zirconia meso
(24 x 23 x 21.5mm) (1 per box)

- 6623016 CEREC Zirconia meso A1 S
- 6582428 CEREC Zirconia meso A2 S
- 6582436 CEREC Zirconia meso A3 S
- 6582444 CEREC Zirconia meso A3.5 S
- 6623024 CEREC Zirconia meso A1 L
- 6582451 CEREC Zirconia meso A2 L
- 6583469 CEREC Zirconia meso A3 L
- 6582477 CEREC Zirconia meso A3.5 L
- 6548692 CEREC Zirconia Meso BL2 S
- 6548700 CEREC Zirconia Meso BL2 L



Try me with...

TiBase

Customise your abutments with a TiBase of your choice and take advantage of the individually designed CEREC Zirconia meso structure.



BLOCKS / ZIRCONIA OXIDE

inCoris ZI meso

For custom zirconium oxide abutments

There is a growing demand for aesthetically perfect implants. Tried-and-tested zirconium abutments made with CEREC allow you to respond individually to your patients' wishes for natural, tooth-coloured, all-ceramic implant-borne restorations. Individual abutments are made out of a titanium base (TiBase) and an individually designed meso structure (inCoris ZI meso block).

- Zirconium oxide blocks with a readymade screw channel
- Rotation security for optimal abutment union
- Two sizes and colours
- After sintering, the mesostructure is adhesively connected to the titanium base (TiBase)
- Time savings compared to central production

inCoris ZI meso

- 20 x 19 x 15.5mm (1 per box)
- 6231802 inCoris ZI meso S F0.5
 - 6231828 inCoris ZI meso S F2
 - 6231810 inCoris ZI meso L F0.5
 - 6231836 inCoris ZI meso L F2

Try me with...

TiBase

Thanks to the readymade screw channel of the meso structure, the blocks are adhesively connected to the TiBase of your choice.



BLOCKS / ZIRCONIA OXIDE

inCoris ZI

Sintered zirconium oxide ceramics for bridge frameworks

The pre-shaded inCoris ZI zirconium oxide blocks are partially sintered. They are designed for the fabrication of crown copings and four-unit bridge frameworks (with up to two pontics) for the anterior and posterior region. After sintering they will acquire the desired properties: Precise dimensions, density, strength, and shade. The inCoris ZI zirconium oxide blocks are available in four different shades (F0.5, F1, F2 and F3).

Benefits at a glance:

- High-performance ceramics for large and delicately designed frameworks
- Outstanding fracture resistance and long service life
- Excellent processing quality and biocompatibility
- Approved for speed sintering and superspeed sintering with inFire HTC speed for the lab

Good to know

Physical data:

- CTE: approx. 11 x 10⁻⁶K⁻¹ (20-500 °C)
- Fracture Toughness: -5.8MPa m^{1/2}
- Density: 6.05 g/cm
- Bending strength: >900MPa
- Grain Size: <0.4 micron



inCoris ZI Blocks

inCoris ZI mono L (20 x 19 x 15.5mm) (3 per box)

- 6235431 inCoris ZI mono L F0.5
- 6235449 inCoris ZI mono L F1
- 6235456 inCoris ZI mono L F2
- 6235464 inCoris ZI mono L F3

inCoris ZI 40/19 (40 x 19 x 15mm) (3 per box)

- 6135912 inCoris ZI 40/19 F0.5
- 6135888 inCoris ZI 40/19 F1
- 6135847 inCoris ZI 40/19 F2
- 6135813 inCoris ZI 40/19 F3

inCoris ZI 65/25 (65 x 25 x 22mm) (1 per box)

- 6173285 inCoris ZI 65/25 F0.5
- 6173293 inCoris ZI 65/25 F1
- 6173301 inCoris ZI 65/25 F2





BLOCKS / ZIRCONIA OXIDE

inCoris TZI

Highly translucent sintered zirconium oxide ceramic for non-veneered restorations

inCoris TZI is used to produce fully contoured crowns and bridges with up to nine units. Thanks to its high translucency, inCoris TZI requires no veneering, making it an inexpensive and more aesthetic alternative to non-veneered and partially veneered metal restorations. inCoris TZI is ideal for patients when PFMs with metal occlusal or full-cast restorations are not an option.

Benefits at a glance:

- Ideal for critical situations with limited space between restoration and antagonists
- No chipping
- Approved for speed sintering and superspeed sintering with inFire HTC speed
- inCoris TZI Colouring Liquid for custom staining of restorations
- After applying colouring liquid and sintering, the restoration can be individualised with conventional stains and glazes

Good to know

Physical data:

- CTE: approx. $10 \times 10^{-6} \text{K}^{-1}$ (20-500 °C)
- Fracture Toughness: -5 MPa m^{1/2}
- Density: 6.05 g/cm³
- Bending strength: >900MPa
- Grain Size: <0.4 micron



inCoris TZI Blocks (Unshaded)

Like the inCoris ZI blocks, the inCoris TZI blocks consist of yttrium-reinforced zirconium oxide. They are not pre-shaded and are available in three standard Dentsply Sirona sizes: mono L (20/19), 40/19 and 55/19.

6339431	inCoris TZI Mono L (20 x 19 x 15.5mm) - 3 per box
6339464	inCoris TZI 40/19 (40 x 19 x 15.5mm) - 3 per box
6339498	inCoris TZI 55/19 (55 x 19 x 15mm) - 2 per box



Required milling instruments for inCoris ZI and inCoris TZI

Block	Option	Left	Right	Application
inCoris ZI and inCoris TZI	Option 1	Step Bur 20	Cylinder Pointed Bur 20	
	Option 2	Shaper 25 RZ	Finisher 10	Wet Milling
	Option 3	Shaper 25	Finisher 10	Dry Milling
InCoris ZI meso	Option 1	Step Bur 20	Cylinder Pointed Bur 20	

Important processing notes for inCoris ZI and inCoris TZI

Please note:

- Do not use CEREC SpeedPaste (or Object Fix) when sintering inCoris ZI or inCoris TZI
- inCoris Zirconia like all zirconia shrinks by roughly 25% when sintered
- CEREC SpeedPaste may be used once the inCoris restoration has been sintered and the shrinkage process is completed
- CEREC SpeedGlaze may be used for glazing inCoris Zirconia

Additional materials for processing inCoris ZI and inCoris TZI

Item Number	Product	Packaging	Process
5809640	Dentatec	1 x 1,000ml	Grinding/Milling
Various	Diamond or Tungsten Carbide Burs (see chart on page 376)	Various	
RA341	EVE Diacomp Plus 2 Step Polishing Set	8 per box	Polishing
6580067	CEREC SpeedPaste	1x 12ml syringe	Glazing
6583889	Glaze Support Multi Unit Pin	1 per box	
6570142	CEREC SpeedGlaze	1x 75ml Spray	
6500826	Tweezers for Furnace	1 per box	



IMPLANT-SUPPORTED RESTORATIONS

TiBase

For custom abutments

TiBase and an abutment screw are used for the digital acquisition of an implant position and for the restorative supply of implants. Instead of a deformation post to transmit the implant position to a model, a Scanbody is required in the digital process. For this purpose, a titanium base (TiBase) is mounted on an implant or laboratory analog with an abutment screw and depending on the acquisition system, a suitable Scanbody is connected to this. The titanium base is designed on the bottom side in line with the implant's specific requirements and can only be screwed onto specific implants with a certain diameter. The top side is formed for the acquisition of a Scanbody and meso block. The TiBase is available for various implant systems and diameters.

TiBase is delivered without Scanbody. Please order separately.

Try me with...

CEREC Zirconia meso

CEREC Zirconia meso blocks are adhesively connected to Dentsply Sirona TiBase for customised abutments. These pre-coloured blocks contain a high level of translucency allowing them to respond individually to your patients' wishes for natural, tooth-coloured, all-ceramic implant-borne restorations.



Astra Tech Osseospeed EV®, Astra Tech Osseospeed TX®, Ankylos®, Frialit®/Xive®

6586304	TiBase AT EV 3.0 GH1 S
6586312	TiBase AT EV 3.6 GH1 S
6586320	TiBase AT EV 4.2 GH1 L
6586338	TiBase AT EV 4.8 GH1 L
6586346	TiBase AT EV 5.4 GH1 L
6282532	TiBase AT OS 3.5/4.0 L
6282540	TiBase AT OS 4.5/5.0 L
6586528	TiBase ANK C/ GH1 S
6586536	TiBase ANK C/ GH2 S
6586544	TiBase ANK /X GH1 S
6586551	TiBase ANK /X GH2 S
6282433	TiBase FX 3.4 S
6282441	TiBase FX 3.8 S
6282458	TiBase FX 4.5 L
6282466	TiBase FX 5.5 L

Nobel Biocare¹ Replace (3-Channel Internal Connector), Nobel Active (Conical Internal Connector), Branmark (External Hex)

6282474	TiBase NB RS 3.5 L
6282482	TiBase NB RS 4.3 L
6282490	TiBase NB RS 5.0 L
6282508	TiBase NB RS 6.0 L
6308188	TiBase NB NA 4.5 L
6308253	TiBase NB A 5.0 L
6282516	TiBase NB B 3.4 L
6282524	TiBase NB B 4.1 L

Straumann¹ Standard Tissue Level and Bone Level

6274231	TiBase S SO 3.5 L
6284249	TiBase S SO 4.8 L
6284256	TiBase S SO 6.5 L
6308154	TiBase S BL 3.3 L
6308337	TiBase S BL 4.1 L

Bioment 3i¹ External Hex and Certain® (Internal Connector)

6282557	TiBase B O 3.4 L
6282565	TiBase B O 4.1 L
6282573	TiBase B O 5.0 L
6308048	TiBase B C 3.4 S
6308097	TiBase B C 4.1 L
6308121	TiBase B C 5.0 L

Zimmer¹ Tapered Screw-Vent

6282581	TiBase Z TSV 3.5 L
6282599	TiBase Z TSV 4.5 L
6282607	TiBase Z TSV 5.7 L

Osstem (USE: Biossen¹) Osstem TS (USA Hiossen ET)

6527035	TiBase O TS 3.5 L
6527043	TiBase O TS 4.0 L

BioHorizons¹ (Internal Connector)

6532779	TiBase BH 3.0 S
6532894	TiBase BH 3.5 L
6532951	TiBase BH 4.5 L
6536242	TiBase BH 5.7 L

Thommen Medical¹ SPI®

6531854	TiBase TM 3.5 S
6532829	TiBase TM 4 S
6532837	TiBase TM 4.5 S
6544360	TiBase TM 5 S
6544378	TiBase TM 6 S

Medentika¹ M-Implant

6308295	TiBase MI 3.5/5.0
---------	-------------------



IMPLANT-SUPPORTED RESTORATIONS

Abutment Screws

The trusted partner for TiBase and ScanPost

Abutment screws serve as a replacement for screws included with the TiBase or ScanPost. They can be used either for final fixation in the mouth or for attaching a laboratory analogue. Each pack contains two identical screws.

Astra Tech Osseospeed EV®, Astra Tech Osseospeed TX®, Ankylos®, Frialit®/Xive®

6586262	Abutment Screw AT EV 3.0
6586270	Abutment Screw AT EV 3.6
6586288	Abutment Screw AT EV 4.2
6586296	Abutment Screw AT EV 4.8
6593714	Abutment Screw AT EV 5.4
6460344	Abutment Screw AT OS 3.5/4.0
6460443	Abutment Screw AT OS 4.5/5.0
6460476	Abutment Screw FX 3.4, 3.8, 4.5, 5.5

Nobel Biocare¹ Replace (3-Channel Internal Connector), Nobel Active (Conical Internal Connector), Branmark (External Hex)

6460526	Abutment Screw NB RS 3.5
6460534	Abutment Screw NB RS 4.3, 5.0, 6.0
6460484	Abutment Screw NB A 4.5
6460492	Abutment Screw NB A 5.0
6460500	Abutment Screw NB A 3.4
6460518	Abutment Screw NB A 4.1

Straumann¹ Standard Tissue Level and Bone Level

6460559	Abutment Screw S SO 3.5
6460567	Abutment Screw S SO 4.8, 6.5
6460542	Abutment Screw S BL 3.3, 4.1

Bioment 3i¹ External Hex and Certain® (Internal Connector)

6460468	Abutment Screw BO 3.4, 4.1, 5.0
6460450	Abutment Screw BC 3.4, 4.1, 5.0

Zimmer¹ Tapered Screw-Vent

6460575	Abutment Screw Z TSV 3.5, 4.5, 5.74
---------	-------------------------------------

Osstem (USE: Biossen¹) Osstem TS (USA Hiossen ET)

6561208	Abutment Screw O TS 3.5
6561232	Abutment Screw O TS 4.0

BioHorizons¹ (Internal Connector)

6561240	Abutment Screw BH 3.0
6561257	Abutment Screw BH 3.5, 4.5, 5.7

Thommen Medical¹ SPI®

6561265	Abutment Screw TM 3.5
6561273	Abutment Screw TM 4.0, 4.5, 5.0, 6.0



¹Not a registered trademark of Dentsply Sirona.

¹Not a registered trademark of Dentsply Sirona.



IMPLANT-SUPPORTED RESTORATIONS

ScanPost

For convenient intraoral acquisition of implant data

In combination with a suitable Scanbody, ScanPosts are used for intraoral optical assessment of the implant location. This makes conventional impressions using impression posts for transfer to plaster model superfluous. ScanPosts are available for various implant systems and in various diameters.

- They can be used up to 50 times
- Each ScanPost is supplied together with a fixation screw
- Two different types of Scanbodies are available, depending on the camera system (for Omnicam and Bluecam)
- A TiBase with the same name extension must be used for the final restoration

ScanPost is delivered without Scanbody. Please order separately

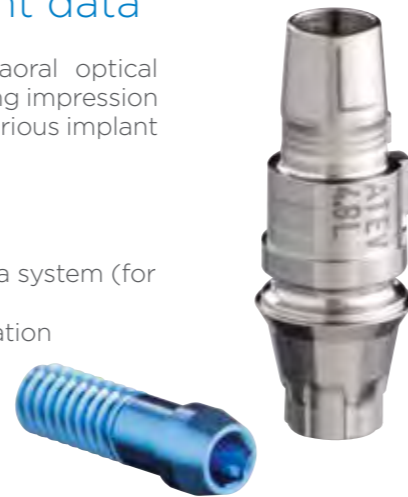

Try me with...

TiBase, Abutment Screw, ScanBody

The very best on the market: This premium package will enable you to provide your patients with quick and efficient intraoral optical assessments of the implant location.



Astra Tech Osseospeed EV®, Astra Tech Osseospeed TX®, Ankylos®, Frialit®/Xive®

6586353	ScanPost AT EV 3.0 S
6586361	ScanPost AT EV 3.6 S
6586379	ScanPost AT EV 4.2 L
6586387	ScanPost AT EV 4.8 L
6586395	ScanPost AT EV 5.4 L
6431055	ScanPost AT OS 3.5/4.0 L
6431063	ScanPost AT OS 4.5/5.0 L
6586569	ScanPost ANK S
6430891	ScanPost FX 3.4 S
6430909	ScanPost FX 3.8 S
6430917	ScanPost FX 4.5 L
6430925	ScanPost FX 5.5 L

Nobel Biocare¹ Replace (3-Channel Internal Connector), Nobel Active (Conical Internal Connector), Branmark (External Hex)

6430933	ScanPost NB RS 3.5 L
6430941	ScanPost NB RS 4.3 L
6430958	ScanPost NB RS 5.0 L
6430982	ScanPost NB RS 6.0 L
6431279	ScanPost NB A 4.5 L
6431287	ScanPost NB A 5.0 L
6431006	ScanPost NB B 3.4 L
6431022	ScanPost NB B 4.1 L

Straumann¹ Standard Tissue Level and Bone Level

6431162	ScanPost SSO 3.5 L
6431170	ScanPost SSO 4.8 L
6431196	ScanPost SSO 6.5 L
6431246	ScanPost S BL 3.3 L
6431253	ScanPost S BL 4.1 L

Bioment 3i¹ External Hex and Certain® (Internal Connector)

6431089	ScanPost B O 3.4 L
6431105	ScanPost B O 4.1 L
6431113	ScanPost B O 5.0 L
6431212	ScanPost B C 3.4 SL
6431220	ScanPost B C 4.1 L
6431238	ScanPost B C 5.0 L

Zimmer¹ Tapered Screw-Vent

6431139	ScanPost Z TS 3.5 L
6431147	ScanPost Z TS 4.5 L
6431154	ScanPost Z TS 5.7 L

Osstem (USE: Biossen¹) Osstem TS (USA Hiossen ET)

6534197	ScanPost O TS 3.5 L
6536846	ScanPost O TS 4.0 L

BioHorizons¹ (Internal Connector)

6532761	ScanPost BH 3.0 S
6532886	ScanPost BH 3.5 L
6532944	ScanPost BH 4.5 L
6536234	ScanPost BH 5.7 L

Thommen Medical¹ SPI®

6544386	ScanPost TM 3.5 S
6544394	ScanPost TM 4 S
6544402	ScanPost TM 4.5 S
6544410	ScanPost TM 5 S
6544428	ScanPost TM 6 S



IMPLANT-SUPPORTED RESTORATIONS

Scanbody

For Sirona TiBase and ScanPost

ScanPost and TiBase can only be used with suitable Scanbodies to optically assess the implant position. These differ according to the scanning system and the connection geometry.

- Scanbodies for Bluecam are white and are compatible with the following scanning systems: inEos X5, inEos Blue, and CEREC AC with Bluecam
- Scanbodies for Omnicam are grey and are for exclusive use with the CEREC AC Omnicam
- Scanbodies are available in two connection sizes (S and L). The last letter in the name of the ScanPost and TiBase designates the matching connection size (S or L). The connection size also applies to the relevant block geometry (e.g. inCoris ZI meso S or L)
- All Scanbodies can be disinfected but are intended for single use only

Good to know

Notes on seating Scanbodies

Because the top of the Scanbody tells the software the correct height and angle of the implant, it's important to visually verify that it's put on properly (see green checkmark to the right). When scanning stone models, this is easy to do because you can trim away any stone material that could keep the Scanbody from fully seating. But when scanning in the mouth, the TiBase doesn't stick up very high so it's difficult to tell if the Scanbody is indexed and fully seated.

That's why Dentsply Sirona came out with ScanPosts. Think of them as long-necked TiBases that you use during intraoral scanning. ScanPosts are autoclavable, so you can use them over and over again. Like the TiBase, the top portion of the ScanPost is either small (S) or large (L). Both the TiBase and ScanPost have a male notch (see red arrows) that index with the female notch of the Scanbody and the base of the milled abutment. After fastening the ScanPost to the implant with the titanium screw, take a radiograph to verify that it's fully seated. Then, place a Scanbody on top and visually verify that it is indexed and fully seated before scanning.



Scanbodies

(36 per pack)

6431311	Scanbody for Omnicam S
6431329	Scanbody for Omnicam L
6431295	Scanbody for Bluecam S
6431303	Scanbody for Bluecam L



IMPLANT-SUPPORTED RESTORATIONS

inPost

For screw-retained bridges and bars on multi-unit abutments

inPosts are Scanbodies for registering the implant position of multi-unit abutments from nt-trading¹ (product: 2-CONnect) and Medentika^{®1} (product: MedentiBASE) on a model. inPost is screwed directly onto the compatible multi-unit abutment. If treated with care, inPost can be used up to 100 times. inPost is not suitable for scanning single tooth restorations.

Requirements:

- inEos X5 scanner
- inLab SW 15.0 (or higher) including implantology module.

6552298	inPost for MedentiBASE Standard
6561091	inPost for MedentiBASE N4010
6559483	inPost for 2-CONnect KS60
6551639	inPost for 2-CONnect KS61



¹Not a registered trademark of Dentsply Sirona.

¹Not a registered trademark of Dentsply Sirona.



ACCESSORIES / COMPLIMENTARY PRODUCTS

Equipment Consumables



Color Calibration Set

Omniscam Consumables

The CEREC Colour Calibration Kit is to be used with 4.5 SW, and has a maximum shelf life of only 2 years. The expiration date can be found on the bottom of the colour calibration set case.

6630714	Colour Calibration Set - 1 set
6605120	CEREC Care HLD Set OC - 1 set
6479021	Colour in Set Change Magazine Set - 1 set

CEREC Contrast Spray for Bluecam and Apollo

Precision at your fingertips

Easy-to-use coating spray for precise optical impressions. Important to note it is a hazardous product (increased air freight charges).

6317932	CEREC Optispray (200ml spray can including 3 special nozzles and 1 stabilisation tube)
6144179	CEREC Optispray (50ml spray can, including 2 special nozzles)
6203819	Special Nozzle for CEREC Optispray - 25 per box
6321850	Stabilisation Tube for CEREC Optispray - per box

CEREC Stone BC

A highlight in dental stone

CEREC Stone BC is a super-hard Type IV gypsum for making models. In combination with CEREC Bluecam, CEREC Stone BC delivers bright, high contrast images (no additional powdering required).

6237510	CEREC Stone BC (2 dosage bottles x 1,200g each)
---------	---

inFire HTC Speed Consumables

6332899	Sinter Cup - 1 per box
6332907	Bottom for Sintering Cup - 1 per box
6332915	Ring for Sintering Cup - 1 per box
6126457	Sintering Pearls - 1 per box

MC X5 Consumables

6496686	Suction Bellows - 2 per box
6385137	Coolant Tank - 1 per box
6526839	Sponge Insert for Door - 10 per box
6385244	Suction Unit - Filter Bag - 2 per box
6385277	Suction Unit - HEPA Filter - 1 per box
6453851	Suction Hose CPL, Replacement - 1 per box

SpeedFire Consumables

6580067	CEREC SpeedPaste (1 x 12ml syringe)
6570142	CEREC SpeedGlaze (1 x 75ml spray)
6576305	CEREC Zirconia Shade Guide
6583871	Glaze Support Single Unit
6583889	Glaze Support Multi Unit
6500826	Tweezers for Furnace
6578095	Filter Bag - 2 per box
6385277	HEPA Filter
5365901205	Firing Pads - 3 per box

MC, MC X, and MC XL Milling Units Consumables

4691916	Locking screw on MC, MC X and MC XL - 1 per box
6385004	Spindle Maintenance Set - 1 set
6129519	Filter MC XL - 1 per box
6129402	Filter MC XL - 6 per box
638067	Filter MC/MC X - 1 per box
6429950	Filter MC/MC X - 6 per box
6541861	Filter MC X5
6573617	Filter Bag - 2 per box
6129519	Filter Unit for Standard Water Container - 1 per box
6129402	Filter Unit for Standard Water Tank - 6 per box

Dentatec

Dentatec is used to clean and lubricate CEREC and inLab systems. This concentrated milling solution is diluted.

5809640	Dentatec (1,000ml)
---------	--------------------



THE DENTAL
SOLUTIONS
COMPANY™

Dentsply
Sirona

» What drives me? Best results. And Primescan is my answer.«

Dr. Carlos Repullo, BDS, DiplImpDent RCS (UK)

Primescan

Engineered for superior performance.

Innovation requires commitment to ambition: Primescan sets new standards in dental technology, making scanning more accurate, faster and easier than ever. It is engineered to enable all kind of treatments, from single tooth to full arch. Primescan produces highly accurate images and allows for fast scanning consolidating 50.000 images per second. The new patented "High Frequency Contrast Analysis" delivers perfect sharpness and an outstanding accuracy. With Primescan, intraoral scanning delivers excellent results like never before.

Enjoy the scan.

Learn more at: dentsplysirona.com/primescan

Alphabetical Index

A	Page
Abutment Screws for BioHorizons ¹	285
Abutment Screws for Bioment ¹	285
Abutment Screws for Dentsply Sirona	285
Abutment Screws for Nobel Biocare ¹	285
Abutment Screws for Osstem ¹	285
Abutment Screws for Straumann ¹	285
Abutment Screws for Thommen Medical ¹	285
Abutment Screws for Zimmer ¹	285
AH 26*	182
AH Plus Jet*	182
AH Plus*	182
AH Temp*	182
Ankylos*	80
AquaCem*	214
Aquasil® Ultra+	202
Assure Plus™	126
Astra Tech Implant System® EV	76
Axeos	46
B	Page
BL E Motor	103
BL Implant Motor	103
BL ISO C Motor	103
BL ISO E Motor	103
BL Motor	103
Blueprint® 20+	206
Burs (milling)	269
C	Page
Calibra® Bio	213
Calibra® Ceram	211
Calibra® Universal	212
Calibra® Veneer	212
Carl	33
Cavitron® 300	129
Cavitron® Jet Plus™	130
Cavitron® Plus™	131
Cavitron® Select™ SPS™	132
Cavitron® Prophy-Jet®	133
Cavitron® DualSelect®	133
Cavitron® Detachable Sterilisable Handpieces	134
Cavitron® Ultrasonic Inserts	135
Celtra® Duo	275
CEREC AF Omnicam	247
CEREC Blocs C	272
CEREC Blocs C PC	273
CEREC Hub	263
CEREC MC X	252
CEREC MC XL Premium Package	252
CEREC Optispray	288
CEREC Primemill	250
CEREC Primescan	244
CEREC SpeedFire	253
CEREC SpeedGlaze	279
CEREC SpeedPaste	279
CEREC Stone BC	288
CEREC Zirconia	279
CEREC Zirconia meso	280
CEREC AC Omnicam	247
ChemFil® Rock	232
Com-Fit®	124

Conform Fit™ Gutta-Percha for ProTaper Gold®	184
Conform Fit™ Gutta-Percha for ProTaper Next®	184
Conform Fit™ Gutta-Percha for WaveOne® Gold	184
Conform Fit™ Gutta-Percha for TruNatomy™	184
Core-X® Flow	199
D	Page
DAC Premium	114
DAC Premium Plus	114
DAC Professional	115
DAC Professional Plus	115
DAC Universal S	112
Delton*	140
Dentatec	288
Dentsply Sirona Universal Stains	277
Dentsply Sirona Universal Glaze	277
Dentsply Sirona Universal Stain and Glaze Liquid	277
DeTrey® Zinc	214
digit Power® Dispenser	203
Disposa-Shield®	125
Dyract® XP	231
E	Page
Endo 6:1	96
Endoactivator*	180
Enhance*	233
Enhance® PoGo*	234
F	Page
Fix Adhesive	206
Fix Solvent	206
G	Page
Glyde™	161
GuttaCore*	186
GuttaCore® for ProTaper Next®	186
GuttaCore® for WaveOne® Gold	186
Gutta-Percha Points	185
Gutta-Smart*	190
Gutta-Smart® Conform Fit™ Gutta-Percha	184
H	Page
Heliodent Plus	56
Hub	263
Hugo	33
I	Page
Imaging - Extraoral Accessories	48
Implant 20:1	95
inCoris TZI	282
inCoris ZI	281
inCoris ZI meso	280
inPost	287
Intego	25
Intego Ambidextrous	29
Intego Pro	27
Integrity® Multi Cure	208
Integrity® TempGrip®	209
Irrigation Needle	181
K	Page
Kalzinol	210
L	Page
LEDview Plus	32
M	Page
M-Access®	162
MELAprint 44	118

N	Page
Neo Spectra™ ST	225
Neo Spectra™ ST effects	226
Neo Spectra™ ST flow	226
NitraDem Direct Connect	116
Nupro®	138
O	Page
Omnicam AC	247
Omnicam AF	247
Omnicam Consumables	288
Orachek Software	262
Orthopos E	38
Orthopos S	40
Orthopos SL	42
P	Page
Palodent® 360	218
Palodent® V3	216
Paper Points for TruNatomy™	183
Paper Points for ProTaper Gold®	183
Paper Points for ProTaper Next®	183
Paper Points for WaveOne® Gold	183
PathFile*	165
Paul	33
Poly-F® Plus	215
Prime&Bond universal™	219
Prime&Bond® one Etch&Rinse	220
Prisma® Gloss™	234
ProFile*	173
ProGlider*	165
ProRinse*	181
Propex® IQ	145
ProTaper Gold®	172
ProTaper Next®	170
ProTaper® for Hand Use (shaping)	168
ProTaper® Retreatment	176
Purevac®HVE	127
Q	Page
QuiXfil*	231
R	Page
ReadySteel®	152
S	Page
Scanbody	287
ScanPost for BioHorizons ¹	286
ScanPost for Bioment ¹	286
ScanPost for Dentsply Sirona	286
ScanPost for Nobel Biocare ¹	286
ScanPost for Osstem ¹	286
ScanPost for Straumann ¹	286
ScanPost for Thommen Medical ¹	286
ScanPost for Zimmer ¹	286
SDR® Plus	224
SICAT Air	61
SICAT Endo	62
SICAT Implant	60
SICAT Function	61
Sidexis 4	58
Sinius	20
SiroImplant	101
SiroLaser Advance Plus	108
SiroLaser Blue	107

SiroNiTi Air Plus Apex	97
SiroNiTi Apex	97
SiroPerio	100
SiroPrep	100
SiroRetro	101
SiroSeal Premium	117
SiroSeal Professional	117
SiroSonic L	99
SiroSonic TL	99
SL ISO Motor	102
SL Motor	102
SmartLite® Pro	223
Spectrum®	227
Sprayvit	104
Start-X*	147
Surefil one™	230
SureSmile	264
T	Page
T1 Classic	90
T1 Line	91
T1 Turbines	85
T2 Line	92
T2 Turbines	86
T3 Line	93
T3 Turbines	87
T4 Line	94
T4 Turbines	89
Teneo	16
ThermaFil®	188
ThermaFil® for WaveOne® Gold	188
ThermaFil® for ProTaper Gold®	188
ThermaPrep® 2	189
TiBase for BioHorizons ¹	284
TiBase for Bioment ¹	284
TiBase for Dentsply Sirona	284
TiBase for Medentika ¹	284
TiBase for Nobel Biocare ¹	284
TiBase for Osstem ¹	284
TiBase for Straumann ¹	284
TiBase for Thommen Medical ¹	284
TiBase for Zimmer ¹	284
TruNatomy™	169
TruNatomy™ Glider	166
Turbine Accessories	89
V	Page
Visco-gel	210
W	Page
WaveOne® Gold	174
WaveOne® Gold Glider	167
X	Page
Xios AE	53
Xios XG Sensors Accessories	52
Xios XG Supreme	51
X-Post®	194
X-Smart IQ™	177
X-Smart® Plus	178
Xive®	78

¹Not a registered trademark of Dentsply Sirona



Our promise to customers, partners and employees

As The Dental Solutions Company™ Dentsply Sirona's comprehensive solutions offering includes leading product brands across consumables, equipment, technology and specialty products. With the broadest clinical education platform and an unparalleled commitment to R&D in dentistry, our mission and vision guide us to continuously aim higher, support our customers and advance patient care around the world.

Our Mission

At Dentsply Sirona, we are focused on empowering dental professionals to provide better, safer, faster dental care. We work with them to envision what's possible, then provide innovative solutions to achieve it. Education and support help move each procedure forward, ensuring the benefits of our innovations are realised. Everything we do is about helping dental professionals deliver the best possible dental care, for the benefit of their patients and practices - today and for years to come.

Our Vision

Our products make a difference to the lives of over six million dental patients every day - helping them eat, speak, and smile with confidence. However, as advanced as dental care is today, we are dedicated to continually improving it together with the professionals on whom patients rely.