

# SureSmile® Patient Kit Wear and Care Guide

 SureSmile®  
Clear Aligners

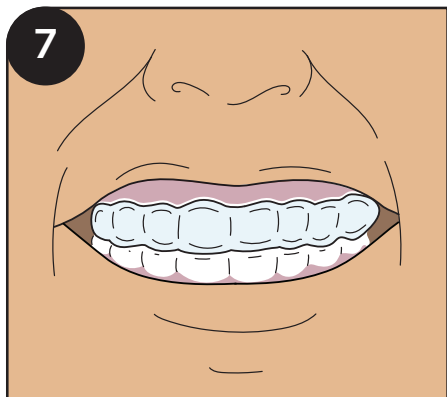
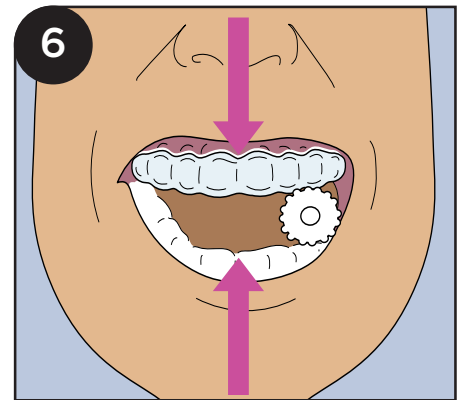
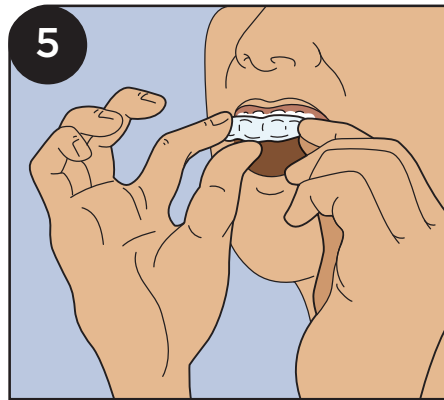
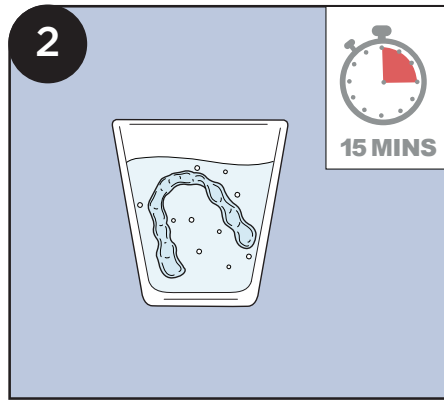
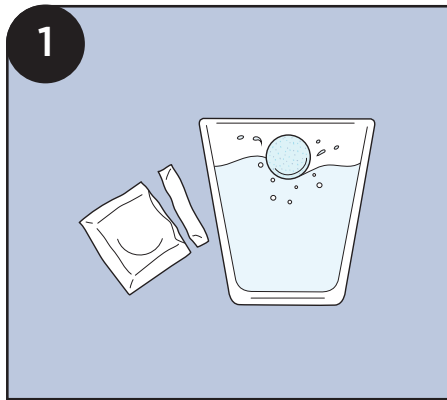
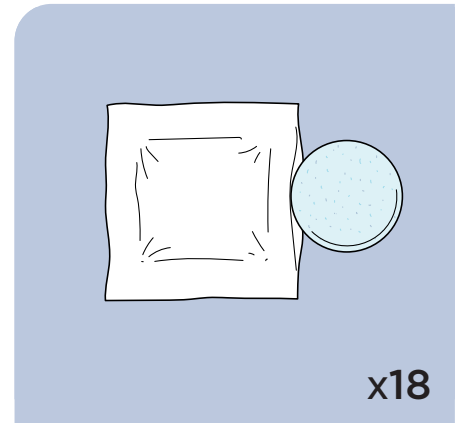
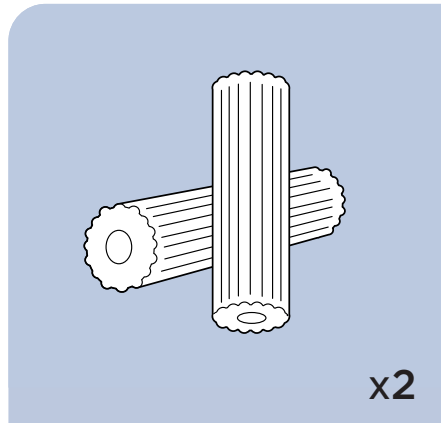
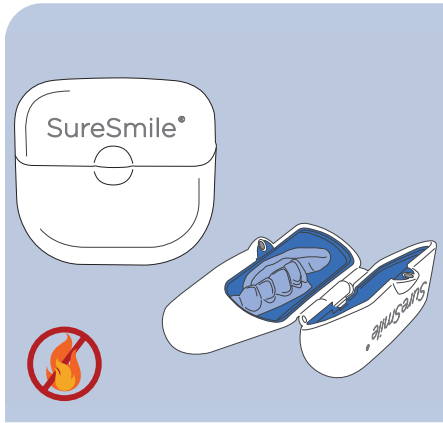

# SureSmile® Patient Kit Wear and Care Guide

 SureSmile®  
Clear Aligners

